

Design and Development of Briquetting Machine for Eco-Friendly Fuel

पर्यावरण-अनुकूल ईंधन के लिये ब्रिक्वेटिंग मशीन का डिजाईन और विकास

Thesis

Submitted to the

**Maharana Pratap University of Agriculture and
Technology, Udaipur**

**In Partial Fulfilment of the Requirements for
The Degree of**

Doctor of Philosophy

in

Agricultural Engineering

(Renewable Energy Engineering)

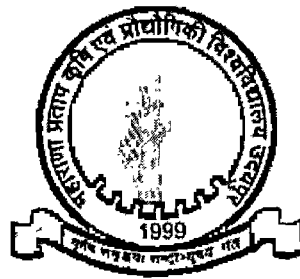

By

DEEPALI S. MANDWE

2010

**MAHARANA PRATAP UNIVERSITY OF AGRICULTURE AND
TECHNOLOGY, UDAIPUR
COLLEGE OF TECHNOLOGY AND ENGINEERING, UDAIPUR**

CERTIFICATE – I

Dated: 14/05/2007

This is to certify that **Miss. Deepali Sahadeorao Mandwe** has successfully completed the comprehensive ^{examination} held on 14th May, 2007 as required under the regulations for **Doctor of Philosophy (Ph. D)** in Agricultural Engineering (Renewable Energy Engineering).

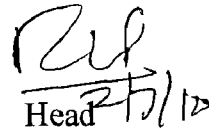
Head

Department of Renewable Energy Sources,
College of Technology and Engineering,
Udaipur

**MAHARANA PRATAP UNIVERSITY OF AGRICULTURE AND
TECHNOLOGY, UDAIPUR
COLLEGE OF TECHNOLOGY AND ENGINEERING, UDAIPUR**

Dated: 03/02/2010

CERTIFICATE – II

This is to certify that this thesis entitled “**Design and Development of Briquetting Machine for Eco-Friendly Fuel**” submitted for the degree of **Doctor of Philosophy (Ph D)** in Agricultural Engineering in the subject of **Renewable Energy Engineering** embodies bonafied research work carried out by **Miss. Deepali Sahadeorao Mandwe** under my guidance and supervision and that no part of this thesis has been submitted for any other degree. The assistance and help received during the course of investigation have been fully acknowledged. The draft of the thesis was approved by the advisory committee on 3rd February, 2010.

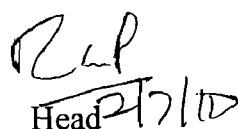
Head

Department of Renewable Energy Sources
Udaipur

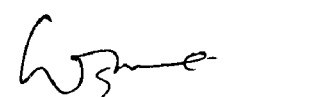
(Dr. Deepak Sharma)
Major Advisor



DEAN
CTAE, Udaipur

**MAHARANA PRATAP UNIVERSITY OF AGRICULTURE AND
TECHNOLOGY, UDAIPUR
COLLEGE OF TECHNOLOGY AND ENGINEERING, UDAIPUR**

Dated: 30/06/2010

CERTIFICATE – III

This is to certify that this thesis entitled “**Design and Development of Briquetting Machine for Eco-Friendly Fuel**” submitted by **Miss. Deepali Sahadeorao Mandwe** to Maharana Pratap University of Agriculture & Technology, Udaipur, in partial fulfilment of the requirement for the degree of **Doctor of Philosophy (Ph D)** in Agricultural Engineering in the subject of **Renewable Energy Engineering**, was after recommendation by the external examiner and defended by the candidate before the following members of the examination committee. The performance of the candidate in the oral examination held on 30.06.2010 was found satisfactory; we therefore, recommend that the thesis be approved.



(Dr. Deepak Sharma)
Major Advisor

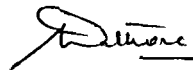

(External Examiner)
(Dr. S. S. Kapdi)

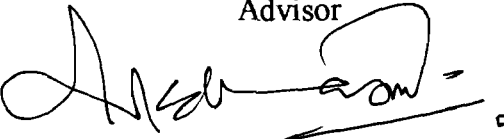
(Dr. N. S. Rathore)
Advisor



(Dr. A. K. Kurchania)
Advisor

(Dr. G. P. Sharma)
Advisor

(Dr. R. C. Purohit)
DRI Nominee

(Dr. R. C. Purohit)
Dean, CTAE, Udaipur

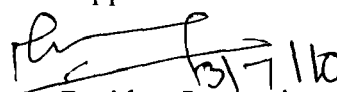
HEAD

Approved

Director Resident Instruction
MPUAT, Udaipur

**MAHARANA PRATAP UNIVERSITY OF AGRICULTURE AND
TECHNOLOGY, UDAIPUR
COLLEGE OF TECHNOLOGY AND ENGINEERING, UDAIPUR**

Dated: 02/07/2010

CERTIFICATE – IV

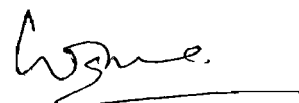
This is to certify that **Miss. Deepali Sahadeorao Mandwe** student of **Doctor of Philosophy** in Agricultural Engineering in the subject of **Renewable Energy Engineering**, Department of Renewable Energy Sources has made all corrections/modifications in the thesis entitled “**Design and Development of Briquetting Machine for Eco-Friendly Fuel**” which were suggested by the external examiner and the advisory committee in the oral examination held on 30.06.2010. The final copies of the thesis duly bound and corrected were submitted on 02/07/2010



(Dr. Deepak Sharma)
Major Advisor

ACKNOWLEDGEMENT

It is my proud privilege to express my devout gratitude and indebtedness to my erudite mentor, veteran Dr. Deepak Sharma, Associate Professor, Department of Renewable Energy Sources, College of Technology and Engineering, Udaipur, for his thoughtful guidance, constant fomenting, punctilious and impeccable advices throughout the course of present study, which inspired me to carry out the research work.

I feel deep sense of gratitude to express my heartfelt thanks to members of my advisory committee, Dr. A. K. Kurchania, Professor, Department of Renewable Energy Sources, Dr. N. S. Rathore, Dean CDFST, Dr. G. P. Sharma, Head, Department of PFE, College of Technology and Engineering, Udaipur, whose rewarding guidance and kind help in providing necessary facilities in time made the research study an achievement.

I owe my heartfelt thanks to the Dr. R. C. Purohit Dean and (DRI nominee) Professor and Head, SWE, College of Technology and Engineering, Udaipur for their kind co-operation which were essential for successfully completion of the project work.

I express sincere gratitude to Dr. Virendra Kumar Shrivastav, Ex-Dean, College of Technology and Engineering, Udaipur for providing all the needed facilities.

My sincere thanks to Dr. Surendra Kothari, Associate Professor, Dr. N. L. Panwar, Assistance professor, Dr. Sudhir Jain, Assistant Professor, Dr. Nafisa Ali, Associate Professor, Department of Renewable Energy Sources, College of Technology and Engineering, Udaipur, for their valuable guidance, constant inspiration, constructive criticism and timely help.

I also record my indebtedness to, Shri Dilip Bhatnagar, Mrs. Kanta Totlani, Shri Paneriji, Shri Metharamji, Shri Jairamji, Shri. Gaharilalji, Shri Ramchandrajji, Shri. Dudalalji and all the staff members of Deptt. of RES, for their presence and unlimited help through out the course of study made it easier.

Formal words are unable to express the intensity and depth of my obligation to Shri. Ajit Nirmale, who has always motivated and supported me during my research work. I am also thankful to my friends Sandeep Subhash, Deepak, Savita, Sushant, Vivek, Chetan, Sunil, Mangesh, Hemant, Sharad and Bhavana who had supported me directly and indirectly for my work.

I express my deeply gratitude to my beloved junior Atul S. Kapre and Aditya Kurhade for helping at final stage of submission which shared lion's part of this work. I would be unfair on my part if I do not acknowledge direct or indirect contribution of my guardian Shri Surendra Kowalia, Sau Pratibha and their daughter Suprit who had always supported me.

Sky is the limit to express a deep sense of gratitude to my beloved parents Shri. Sahadeora, mother Sau Manorama, brother Atul, sisters Rupali and Vaishali tai, Jijaji Shri Pravin Gulhane and Rriti vaini who had laid a perfect foundation, by showing me the path for the bright future.

Finally, my biggest debt of gratitude is owed to my husband Shri. Nitin Gulhane for his love, moral support and understanding and my father in-law, Shri. Vishnupant, mother in-law Sau. Shakuntala and brother in-law, Amit for their inspiration and patience that made this work ever possible.

Place: Udaipur

Date : 2/6/2010

*Mandwe
(Deepali S Mandwe)*

TABLE OF CONTENTS

Chapter	Description	Page No.
	Acknowledgement	
	List of Tables	i
	List of Figures	ii
	List of Plates	iii
	List of Appendices	iv
	Abbreviations and Symbols	v
	List of Nomenclatures	vii
I	Introduction	1-4
1.1	Importance of proposed work	1
II	Review of Literature	5-39
2.1	Energy potential of agro-residue and its utilization for safe disposal	5
2.2	Scope of biomass Utilization	9
2.3	Biomass characteristics	10
2.4	Making of briquette	15
2.5	Briquetting methods and briquetting machine	17
2.5.1	Manually operated machines	26
2.5.2	Animal operated briquetting machine	28
2.5.3	Power operated briquetting machine	29
2.5.3.1	Roller press	29
2.5.3.2	Piston press	32
2.5.3.3	Screw press	33
2.6	State of arts of power operated briquetting plants	35
2.7	Economics	39
III	Material and Methods	40-64
3.1	Property of Raw Mustard stalk	40
3.1.1	Potential of different biomass in Rajasthan State	40
3.1.2	Properties of mustard stalk	40

3.1.2.1	Moisture content	41
3.1.2.2	Bulk density	41
3.1.2.3	Calorific value	42
3.1.2.4	Angle of repose	42
3.1.2.5	Determination of static coefficient of friction	44
3.1.2.6	Proximate analysis	44
3.1.2.6.1	Volatile matter	44
3.1.2.6.2	Ash content	45
3.1.2.6.3	Fixed carbon	45
3.1.2.7	Chemical property of mustard stalk	45
3.1.2.8	Thermo gravimetric analysis	48
3.2	Designing of Prototype Briquetting Machine	48
3.2.1	Screw press briquetting machine	50
3.2.2	Components of briquetting machine	50
3.2.3	Anderson vector shaft analysis technique	51
3.2.4	Theoretical considerations	52
3.2.5	Design consideration	52
3.2.5.1	Calculation of helix angle	52
3.2.5.2	Determination of theoretical screw volume per pitch	53
3.2.5.3	Determination of screw revolution	53
3.2.5.4	Determination of drive power	53
3.2.5.5	Pulley shaft power	54
3.2.5.6	Motor power	54
3.2.5.7	Actual motor speed	54
3.2.5.8	Design of pulley	54
3.2.5.9	Design of connecting shaft	55
3.2.5.10	Selection of bearing	56
3.2.5.11	Selection of belt	56
3.2.6	Design of preheating system	56
3.2.6.1	Design considerations of screw conveyer for preheater	56
3.2.6.2	Estimation of speed of screw conveyer	57
3.2.6.3	Estimation of horse power required	57
3.3	Evaluation of Performance of Briquetting Machine and Briquettes	57

3.3.1	Performance evaluation of briquetting machine	57
3.3.2	Production of briquettes	57
3.3.3	Volumetric energy density of briquette	58
3.3.4	Efficiency of heater	58
3.3.5	Efficiency of briquetting process	59
3.3.6	Specific energy consumption of screw press briquetting machine	59
3.3.7	Properties of briquettes	59
3.3.7.1	Briquette density	60
3.3.7.2	Radial compressive strength	60
3.3.7.3	Briquette durability	60
3.3.7.4	Shatter index	61
3.3.7.5	Water resistance	62
3.3.7.6	Stability of briquettes	62
3.4	Evaluation of Techno-Economic of Briquetting Process	62
3.4.1	Economic evaluation of briquetting	62
3.4.1.1	Net present worth	63
3.4.1.2	Benefit Cost Ratio	63
3.4.1.3	Payback Period	64
IV	Results and Discussion	65-98
4.1	Study of the Physio-Chemical Properties of Agro-Residues.	65
4.1.1	Availability of biomass & its utilisation pattern	65
4.1.2	Potential and suitability of available biomass	68
4.1.3	Properties study of mustard stalk used for briquetting	72
4.1.3.1	TGA Analysis of mustard stalk	73
4.2	Design of Prototype Briquetting Machine	75
4.2.1	Die of the briquetting machine	75
4.2.2	Calculation of helix angle	75
4.2.3	Determination of theoretical screw volume per pitch	76
4.2.4	Determination of screw revolution	76
4.2.5	Determination of drive power	76
4.2.6	Pulley shaft power	77
4.2.7	Motor Power	77

4.2.8	Actual motor speed	77
4.2.9	Design of Pulley diameter	78
4.2.10	Big pulley diameter	78
4.2.11	Design of Shaft	78
4.2.12	Selection of bearing	79
4.2.13	Selection of belt	79
4.2.14	Developed briquetting machine	79
4.2.15	Design of preheating system	81
4.2.15.1	Design Considerations for screw conveyer of preheater	81
4.2.15.2	Heating system for preheater	82
4.2.15.3	Feeding hopper	83
4.2.15.4	Estimation of conveyer Speed	83
4.2.15.5	Design of Conveyer flight	85
4.2.15.6	Determination of mass flow rate	85
4.2.15.7	Determination of drive power	85
4.2.15.8	Pulley Shaft power	86
4.2.15.9	Motor Power	86
4.2.15.10	Actual motor speed	86
4.2.15.11	Design of Pulley	87
4.2.15.12	Design of Shaft	87
4.2.15.13	Selection of bearing	88
4.2.15.14	Selection of belt	88
4.3	Evaluation of performance of briquetting machine and briquettes	89
4.3.1	Production of briquettes	89
4.3.2	Properties of briquettes	89
4.3.2.1	Radial compressive strength	90
4.3.2.2	Water resistance	90
4.3.3	Performance evaluation of briquetting machine	92
4.3.3.1	Production of Briquette	92
4.3.3.2	Performance of briquetting machine	92
4.3.3.3	Efficiency of heater	93
4.3.3.4	Efficiency of briquetting process	93

4.3.3.5	Volumetric energy density of briquette	94
4.3.3.6	Specific energy consumption of Screw press machine	94
4.3.3.7	Effect of moisture on capacity of briquetting machine	95
4.3.3.8	Effect of moisture content on briquetting efficiency	95
4.4	Evaluation of techno-economic of briquetting process.	95
4.4.1	Cost Analysis	95
4.4.2	Net present Worth	98
V	Summary and Conclusions	99-100
VI	Suggestion for Future Work	101
VII	References	102-110
	Abstract in English	111-112
	Abstract in Hindi	113
	Appendices	114-118

LIST OF TABLES

Table	Title	Page No
2.1	Physical properties of sugarcane leaves (chopped) and bagasses	11
2.2	Proximate and ultimate analysis of sugarcane leaves bagasse	11
2.3	Proximate and ultimate analysis of wood chip	12
2.4	Proximate Analysis of Eucalyptus, Leuceana Leucocephala and Acaciaauriculiformis	13
4.1	Availability of agricultural residues, their product to residue ratio and present uses	66
4.2	Estimated potential of agricultural residues as energy fuel in different districts of Rajasthan state in 2005-06. (Production in tones)	69
4.3	Properties of mustard stalk utilized for briquetting	72
4.4	Specifications of the screw press briquetting machine	79
4.5	Specifications of Preheater	83
4.6	Main characteristics of mustard stalk briquette	89
4.7	Characterisation of the mustard stalk briquette	90
4.8	Radial compressive strength of Mustard stalk briquette	90
4.9	Performance characteristics of produced briquettes	92
4.10	Power consumption for Briquetting of mustard stalk with pre-heating	93
4.11	Cash flow analysis for briquetting	97
4.12	Net present worth of the briquetting	98

LIST OF FIGURES

Figure	Title	Page No
1.1	Domestic energy supply pattern	2
1.2	Domestic energy consumption pattern	2
2.1	Technique of Briquetting of Fine Mass	27
2.2	Hand Operated Briquetting Machine	27
2.3	Pedal Operated Briquetting Machine	28
2.4	PARU Briquetting Technique	30
2.5	Roller Press Briquetting machine	31
2.6	Conical Extruder Screw	34
2.7	Screw Press Technology	35
3.1	Flow chart for quantification of lignin	46
4.1	Surplus Biomass available in Rajasthan state (Year 2005-06)	71
4.2	Percentage Wise Contribution of Surplus Biomass	71
4.3	Weight loss of mustard stalk sample with temperature	74
4.4	Weight loss of mustard stalk sample with time	74
4.5	Variation of density with pressure at different temperatures for mustard stalk	81
4.6	Variation in density with temperature for different materials	82
4.7	Right hand Screw Conveyer for preheating	84

LIST OF PLATES

Plate	Title	Page No
3.1	Electrical oven	43
3.2	Bomb calorimeter	43
3.3	Pictorial view of instrument for Angle of repose	43
3.4	Pictorial view of instrument for of Static Coefficient of Friction	43
3.5	Muffle furnace	47
3.6	Non contacting thermometer	47
3.7	Thermo Gravimetric Analyser (TGA)	49
3.8	TGA Analyser in working for mustard stalk analysis	49
3.9	Components of screw press briquetting machine	49
3.10	Durability Measuring Setup	61
4.1	Pictorial view of Mustard Stalk used as energy fuel	72
4.2	Developed Screw Press Briquetting Machine with Heated Die	80
4.3	Developed screw press Briquetting machine with Preheater system	80
4.4	Die with Mica band heating system	80
4.5	Temperature control panel for Mica band heaters of preheater	84
4.6	Briquetting machine control panel with variable drive for Preheater	84
4.7	Preheater system with mica band heater, sensors and control panel	88
4.8	Pictorial view of Mustard stalk briquette	91
4.9 (a)	Performance of Screw press briquetting machine	91
4.9 (b)	Performance of Screw press briquetting machine	91

LIST OF APPENDICES

Appendix	Title	Page No
I	Data for typical allowances made for motor efficiency	114
II	Data for percent slip of different types of electric motors	115
III	Cross section selection chart	116
IV	Total expenditure for fabrication of Briquetting machine with Preheater (as on Jan 2008)	117-118

ABBREVIATIONS AND SYMBOLS

%	-	Per cent
η_c	-	Conveyer efficiency
$^{\circ}\text{C}$	-	Degree centigrade
ρ	-	Mustard stalk density
Agril	-	Agricultural
Anon	-	Anonymous
approx.	-	Approximate
ASAE	-	American Society of Agricultural Engineering
ASTM	-	American Society of Testing Materials
avg	-	Average
cal	-	Calorie
Cc	-	Cubic centimetre
cm	-	Centimeter
Cp	-	Specific heat of biomass
CTAE	-	College of Technology and Engineering
CV	-	Calorific Value
Deptt	-	Department
Dia	-	Diameter
Ed	-	Edition
Engg	-	Engineering
F.C.	-	Fixed Carbon
Fig	-	Figure
gm	-	Gram
h	-	Hour
i	-	discount rate
IREDA	-	Indian Renewable Energy Development Agency
ISAE	-	Indian Society of Agriculture Engineers
kcal	-	Kilo calorie
kg	-	Kilogram
kW	-	Kilo watt
lit	-	Liter

M	-	Meter
M.C.	-	Moisture Content
MJ	-	Mega joule
M.S.	-	Mild steel
Max	-	Maximum
min	-	Minute
Mini.	-	Minimum
mm	-	Millimeter
No.	-	Number
NPW	-	Net Present Worth
Rs	-	Rupees
S	-	Second
T	-	Tonne
V.M.	-	Volatile Matter
w.b.	-	Wet basis

LIST OF NOMENCLATURE

ρ	Density of biomass (kg/m ³)
S	Pitch (m)
D	Screw press diameter (m)
R_1	Inner radius (m)
R_2	Out radius (m)
Q	Production capacity
N	Speed of screw press (rev/min)
V_s	Theoretical screw volume
ϕ	Filling ratio of screw
\dot{m}	Mass flow rate
P	Power
η_d	Drive efficiency
f_i	Displacement factor of screw
T	Torque
d	Diameter of shaft
N_s	Speed of screw conveyer
s	Slip factor of motor
P_m	Motor power
P_s	Shaft power

INTRODUCTION

This chapter deals with the basic information of the briquetting technology used for the experiment in Rajasthan and the justification for the necessity of work to be carried out with important objectives.

1.1 Importance of Proposed Work

Adequate supply of energy at a reasonable cost is a key factor in the economic development of country. During the industrial revolution, coal was the most preferred form of energy which brought about far reaching changes in the commercialisation of the traditional processes. This was followed by oil which was helpful in many significant transformations, particularly in the transport, agricultural and industrial sectors. After 1973 oil crises, serious thought began to be given to search alternative renewable and non renewable and non polluting sources of energy, such as hydro, solar and bio energy, which are particularly promising for countries like India, in all sectors, including household (Dayal, 1985).

The per capita energy consumption in India is about 315 KCE only (Rathore et al., 1994). The energy scenario in rural areas is worse, complex, mixed and biomass based. The traditional energy fuels such as firewood, crop residues, animal dung etc. are estimated to account for over 50 percent of the total energy consumption in the country, but their share for domestic energy is more than 75 per cent as evident from Fig. 1.1. Major share of this energy is consumed in cooking alone as shown in Fig. 1.2 (Vimal, 1989).

Biomass is the third largest primary energy resource in the world, after coal and oil. In all its forms, biomass currently provides about 1250 million tonnes oil equivalent (MTOE) of primary energy. The renewable source of energy based on biomass was utilized to fulfil world's 14 per cent of energy supply (Hall D. O. et al. 1991). For developing and agriculture based countries, the utilization of the residues from agricultural sector as primary or secondary source of energy is considerably attractive. With regards to energy shortage and environmental issues, it is widely accepted that renewable energy seems to be one of the promising energy resource and

shall play a major role in the foreseeing years. Direct combustion of biomass may generate smoke and is not efficient. Briquetting of biomass provides cleaner fuel for power generation and thermal application directly or after charring (pyrolysis).

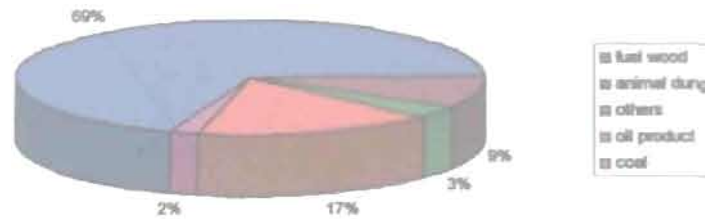

Fig. 1.1 Domestic energy supply pattern

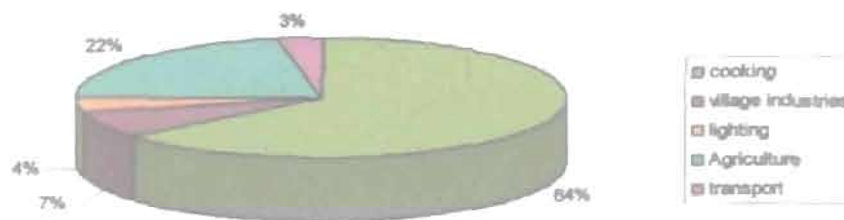

Fig. 1.2 Domestic energy consumption pattern

In India plenty of biomass is available due to vast agricultural production. An overall potential of 17,000 MW of power generation through the use of various types of biomass materials has been estimated (Bhattacharya 2003). Common aspects, which are important for the development of briquetting, are the demand for wood and wood products, particularly charcoal, which is the fuel of choice in many urban areas. Deforestation is an actual or potential problem for supply of biomass. The supply of a substitute for fuel wood in the household sector has emerged as a policy priority in many countries and in the funding agencies, which support many energy projects.

It is observed that several kinds of agricultural residues are available and are not ready to be utilized as fuel directly. As compared to other kinds of fuels, agricultural residues have lower energy density. Besides, the low density and dusty characteristics of biomass also cause problems in transportation, handling, storage, entrained particulate emission control and direct combustion.

Charcoal is a premium fuel widely used in many developing countries to meet household energy demand as well as variety of other needs. It is however often difficult, if not impossible, to find a sufficient supply of firewood. Biomass is an organic material which has stored sunlight in the form of chemical energy. Biomass fuels include wood, straw, manure, sugar cane, and many other byproducts from a variety of agricultural processes. The use of biomass feedstock for the substitution of fossil fuel has an additional importance from climate change considerations since biomass has the potential to be CO₂ neutral. The abundant availability of biomass resources and the fact that the number of domestic competitors is still limited, the prospects for the densified biomass industry in India, seems to be good. Substitution of wood and charcoal by biomass briquette, which is prepared from agricultural and forestry residues, appears to be an attractive option to alleviate the traditional fuel crisis faced by many developing countries (Hall et al. 1991).

Now a day's briquetting technology plays an important role in the utilization of agro-wastes for higher calorific value and high-energy utilization. In this study, a briquetting process will aim to investigate production of an alternate eco-friendly fuel. Rajasthan has major contribution towards yellow revolution in the country. Rajasthan is having large production capacity of mustard with large amount of waste after harvesting. The calorific value of biomass is high and finally used as fuel for cooking at domestic level or it is burnt on farm as it causes spoilage and disposal problem all over the year. The use of mustard stalk waste for production of briquette improves the net calorific value per unit volume and also helps to reduce deforestation by providing a substitute for fuel wood as well as conventional fuel. The technology of briquetting is defined as the densification process for improving the biomass fuel characteristics.

The important properties of briquettes affected the fuel quality are their physical and chemical attributes. Briquetting process is one of the promising technologies, which has been investigated by several researchers. Briquetting process is used to improve the bulk density of raw material and solve the problem of storage of waste available on farm for a year. Indirectly it is a way to utilize the total energy available on farm to generate electricity/thermal heat through the route of gasification technology.

Advantages of briquetting:

- ❖ Briquetting of biomass carries tremendous scope and potential in converting the agro residues into a more usable form as a fuel.
- ❖ This technology is used to compact the biomass/agro-residues into high density briquettes. This eliminates problems of handling, storage and transportation.
- ❖ Briquetting of biomass will help to generation Employment in rural areas of developing countries
- ❖ Briquettes being a substitute for wood, their progressive use should form an integral part of National/International reforestation and environmental programmes.

It is proposed to develop an efficient briquetting machine capable to produce briquettes of mustard stalk that can be used as eco-friendly fuel for cooking in chulhas as well as for gasification to produce electricity. It has also potential to sale directly in market for use in boilers. It is worth mentioning that briquetting technology in India has not yet reached at maturity stage and there is considerable scope for design improvements, leading to increased reliability and reduced energy consumption for the briquetting of agricultural residues. The study on briquetting of agro-waste was undertaken to reduce the pollution and its utility for power generation with the following objectives:

1. To study the physio-chemical properties of selected agro-residue.
2. To design and develop a prototype briquetting machine suitable for mustard stalk.
3. To evaluate performance of briquetting machine and briquettes.
4. To evaluate techno-economic feasibility of briquetting process.

REVIEW OF LITERATURE

This chapter deals with the review of literature used for the present study and the supporting references for methods used in research. The reviews are divided under following heads:

- (i) Energy Potential of Agro-residue and its Utilization for Safe Disposal
- (ii) Scope of Biomass Utilization
- (iii) Biomass Characteristics
- (iv) Making of Briquette
- (v) Briquetting Methods and Briquetting Machine
- (vi) State of Arts of Power Operated Briquetting Plants
- (vii) Economics

2.1 Energy Potential of Agro-Residue and Its Utilization for Safe Disposal

The energy potential studies have been attempted by many scientists to know the energy potential cum consumption pattern and sources of energy available in a village.

Biomass is a natural product of solar energy, and therefore, a renewable source of carbon and hydrogen which are the basic constituents of energy and chemical products. Worldwide the energy stored in the biomass through photosynthesis is approximately 3×10^{21} J every year, which is nearly 10 times the world's annual energy use. The plant biomass is often called phytomass. The energy from the sun gets converted into biomass from different routes to provide sustenance to the biosphere. Biomass is the third largest primary resource in the world after coal and oil. In all its forms, biomass currently provides about 1250 million tones oil equivalent (mtoe) of primary energy which is about 14% of the world's annual energy consumption. Biomass can be converted into energy by simple combustion, by co-firing with other fuels or through some intermediate process such as gasification, anaerobic digestion (suited only for non lingo-cellulosic materials) to produce methane or fermentation to produce ethanol (Brandt 1990).

Akdeniz *et. al.* (2004) stated that cotton was planted on a large scale in Turkey and was one of the Turkey's most important agricultural crops as Turkey was one of the 8 countries producing 85% of the world's cotton. It was estimated that the maximum amount of cotton stalk available in Turkey was 4.41 million tons annually, and Turkey's energy equivalence of cotton stalk was 75.62 PJ (1.717 million tons of oil equivalent), which corresponded to 6.3 % of Turkey's primary energy production in 1999. A net energy of 39,028 MJ/ha may be produced from a cotton field every year, which was why there was interest in cotton stalk use. A good residue management system should also be installed throughout the country for the optimum use of these residues. It was also expected that the results of this study will be helpful in developing highly applicable and productive planning for energy policies.

Anon (1997) found that the large quantities of agricultural residues produced in developing countries could play a significant role in meeting their energy demand. However, the abundant quantities of agricultural wastes and forest residues were neither managed effectively nor utilized efficiently. In the case of Nepal, these shortcomings are observed even in the management and utilization of wastes from medicinal herbs and aromatic plants. The biomass wastes can be upgraded into a more convenient fuel by briquetting. Recognizing this, the Royal Nepal Academy of Science and Technology (RONAST) has been conducting research and development activities in the field of biomass briquetting since 1997. The academy has been successful in producing biomass briquettes from alternate raw materials besides rice husk. Problems associated with the high cost and wearing of screw have also been addressed. Realizing the role of appropriate cooking devices, RONAST has developed new briquette burning devices and modified traditional stoves for firing biomass briquettes. This paper highlights the findings related with the briquetting of alternative raw materials like pine needles, banmara, wood shavings, aromatic and medicinal herbs, plastic waste etc. It also discusses about a new cost effective technique of fabricating the screw used in the heated-die screw-press briquetting machine, and its performance. The paper also provides an insight to the user's perception of briquettes as domestic fuel.

Bhattacharya (2003) studied that the biomass provided the basic energy requirements for cooking and heating in rural households and for processes in a variety of traditional industries in developing countries. In general, biomass energy used in such cases was characterized by low efficiency. Potentially, efficiency improvements of existing energy systems could increase the energy supply from biomass substantially. Also, wide range of biomass energy technology was now in different stages of development and commercialization. Technologies which are expected to play a major role in meeting energy demand in the future, as well as policy options for promoting their commercialization were considered.

Grover (2004) stated that biomass is the only natural and renewable storehouse of carbon and hydrogen which has the basic elemental constituents of energy and chemical products with its annual generation rate of at least 10 times than the present world's energy consumption. Since the dawn of civilization, biomass has been the traditional source of energy. However, its importance got temporarily eclipsed due to the discovery of fossil fuels. Because of their convenience and superior economics these fossil fuel got intensive developmental input and in the process these sources got thoroughly classified and characterized. Similar efforts should be directed towards biomass fuels which offer a sustainable alternative to the depleting hydrocarbon resources. Technically all types of fuel and product can be obtained from biomass. Therefore it becomes imperative that biomass species should also be thoroughly characterized for their generation, collection, processing and usage. The present status of biomass characterization has been presented in this report, starting with its broad classification into woody and non-woody species followed by further classification of agro-residues in terms of powdery, granular and stalk like materials. Their properties in terms of physical, feed preparation, thermo-chemical, chemical and summative analyses and rate studies with specific product distribution of drying, pyrolysis, gasification and combustion are presented along with available data. The present level of biomass properties and data are not sufficient to exploit its full potentials. Therefore, the objective of this presentation was to further simulate research in developing much more data and novel properties and techniques so that the biomass development was brought to the same level as that of fossil fuels.

Hall *et. al.*, (1993) studied that the technological progress in biomass energy was derived from two spheres - biomass energy production practices and energy conversion technologies. A rich experience of managing commercial energy plantations in varied climatic conditions has emerged during the last two decades.

Pathak *et. al.* (2004) reported an attempt made to assess the quality of total production and surplus availability of biomass and waste in 1997 and 2001 from crops and agro-processing residues, grasslands, forests, roadsides, agro-forestry and degraded habitats which could be diverted for energy generation. Projections for 2015 have also been made on the basis of growth-trend analysis and assumptions where possible. As per the estimates, about 249.78 MT of surplus biomass was available in 2001 from all sources mentioned above. Their availability was likely to increase to about 384.51 MT by 2015. Substantial quantity of this surplus biomass could be utilized for energy generation.

Ravindranath and Hall (1995) concluded that estimation of biomass consumption remain highly variable since most biomass was not transacted on the market. Supply-side estimates of biomass energy are reported as: fuel wood for domestic sector- 218.5 million tons (dry), crop residue- 96 million tons and cattle dung cake- 37 million tons. Supply of biomass was primarily from fuels that are home grown or collected by households for own needs. The Government sponsored social forestry programme has added to fuel-wood supply to the tune of 40 million tons annually.

Shukla, (1997) stated that future of biomass energy depends on providing reliable energy services at competitive cost. In India, this will happen only if biomass energy services can compete on a fair market. Most economical option was utilization of waste materials. Potential availability of agro residues and wood processing waste in India can sustain 10,000 MW power. Biomass waste however shall be inadequate to support the growing demands for biomass resources. Sustained supply of biomass shall require production of energy crops (e.g. wood fuel plantations, sugar cane as feedstock for ethanol) and wood plantations for meeting growing non-energy needs.

Toan *et. al.* (2000) studied that commercial energy consumption accounted was 35-40% of total energy consumption in Vietnam; the remaining was non-commercial

energy, of which biomass contributed 75-80%. Biomass energy was used by rural people not only in the household but also for productive activities. Although briquetting of biomass residues e.g. rice husk, saw dust etc. can largely overcome some of the major problems regarding their utilization for energy, particularly low bulk density, the technology did not attract enough attention until recently. An attempt was made to introduce this technology in Vietnam within the framework of a Regional Renewable Energy Project funded by the Swedish International Development Cooperation Agency (Sida) and coordinated by the Asian Institute of Technology (AIT), Bangkok.

Xianyang *et. al.* (2007) found that China has one of the most abundant straw resources in the world, producing more than 620 million tons of straw in 2002, and representing about 33–45% of energy consumption for livelihood in rural areas. Utilization of straw as energy with high efficiency and rationality not only meets the demands for energy as the economy grows, but also provide a basis for environmental protection and sustainable development of society in China. This paper reviews the present utilized technologies of straw in biomass energy, including improved stove, biogas, straw gasification and straw briquette, which are already commercialized and popularized in China. Other technologies, such as liquefaction, straw carbonization and bio-coal, are also presented. Based on the technology status and potential, the future research and development of straw in the biomass energy portfolio in China were proposed.

2.2 Scope of Biomass Utilization

Alam (2000) reported that biomass conversion and management technologies had very important role in rural development in India. These technologies offered a great challenge to the conventional sources and put to the service of rural people development, specially improved cooking stoves, biogas and producer gas.

Koopmans and Heruela (1999) reported that total biomass energy use, according to the model used by IIASA/world energy council, was estimated to be about 849 MTOE in 1990 or about 9.5% of all energy consumed on a world-wide basis and 1,095 MTOE or

12.2% if modern biomass energy is included. These figures are expected to change to 842 MTOE (8.3%) or 1,170 MTOE (11.5%) in 2000 and respectively 857 MTOE (6.3%) of 1,330 MTOE (9.8%) in 2020 for traditional biomass and all biomass. In contrast, the other renewable sources of energy (solar, wind, geothermal, tide, etc.) would account respectively for about 0.2%, 0.54% and 2.23% in 1990, 2000 and 2020. All this shows that biomass energy is at present an important source of energy being the most important fuel on a worldwide basis after oil, coal and natural gas.

Munoz *et. al.* (2000) reported that European commission set a target of the use of renewable energy technologies (ret) as the doubling of their contribution from the present 5.6 per cent to about 12.5 per cent. Amongst all the renewable energy sources, biomass represented the highest potential and it was generally accepted that it would have to play major role in meeting these targets.

Singh *et. al.* (1990) emphasized the potentiality of gasifier being an efficient link between the need for energy and energy resource base. They also stressed that among biomass conversion processes, gasification technology acquires a significant importance in present energy scenario.

2.3 Biomass Characteristics

ASAE standards (1998) were developed to determine the moisture content of the samples, specially the ASAE S358.2 standard was used. An oven for drying with temperature sensitivity of $\pm 2^{\circ}\text{C}$ in the range of 50 to 150 $^{\circ}\text{C}$ was used for the moisture content determination at wet basis (w.b.). The moisture content levels were obtained by adding water on the sample and leaving rest by 24 hours in close bag. The die temperature was controlled through use of an electrical heater fitted around the die. A type-K thermocouple was placed in a hole made in the die and it was used to control the die temperature. After the die temperature was reached, ten minutes were allowed before the experimental run. The different levels of die length were obtained by changing the die.

Bhat *et. al.* (2001) analyzed an average size of the rice husk char of about 10 μ m. Proximate composition of the rice husk char as per ASTM D 3173-74 standards was found to have fixed carbon 49.72 per cent, ash content 46.02 per cent and volatile matter 4.15 per cent.

Gangde *et. al.* (1998) determined the physical properties; proximate analysis and heating values of babool (*acacia nilotica*) wood without bark, subabool (*leucaena leucocephala*) roundwood with bark, safflower (*carthamus tinctorius*) residue briquette and tur (*cajanus cajan*) stalks were studied. Moisture content was below 10 per cent in all four fuels. Babool wood had the highest bulk density and volatile matter as 0.73 t m⁻³ and 83.63 per cent, respectively. Subabool had the greatest heating value 18.68 MJ kg⁻¹ LHV and least ash content 1.6 per cent than rest of the fuels. Safflower residue briquette had the highest ash content 14.82 per cent and lowest value of fixed carbon 9.1 per cent.

Jorapur and Rajvanshi (1997) analyzed agricultural residues like sugarcane leaves and bagasse. The physical properties, proximate and ultimate analysis of sugarcane leaves and bagasse are below-

Table 2.1 Physical properties of sugarcane leaves (chopped) and bagasses

	Chopped sugarcane leaves	Bagasse
Particle size, cm	1-10	<5
Bulk density, (dry) kg m ⁻³	25-40	50-75
Moisture content, % w/w (wet)	<15	10-15

Table 2.2 Proximate and ultimate analysis of sugarcane leaves bagasse

Proximate analysis	Sugarcane leaves	Bagasse
Fixed carbon, %	14.9	20.1
Volatile matter, %	77.4	75.8
Ash content, %	7.7	4.2
Higher heating value, MJ kg ⁻¹	17.43	18.11
Ultimate analysis		
Carbon, %	39.8	44.1

Hydrogen, %	5.5	5.26
Oxygen, %	46.8	44.4
Nitrogen, %	-	0.19

Karaosmanoglu *et al.* (1999) stated that the oil seed plants are important biomass sources. The rapeseed plants yield a high amount of vegetable oil, having major position among other oil seed plants. In this study the straw stalk of the rapeseed plant was selected as a biomass energy source. The characterization of the straw stalk of rapeseed plant was having 75.43% holo-cellulose, 50.83% alpha cellulose, 19.34% lignin and small amounts of extractive matters. The rapeseed straw stalk comprised of 5.87% ash, 75.55% volatile matter and 18.58% fixed carbon. It was found that it was rich in carbon and contains a considerable amount of oxygen and trace amounts of sulphur and nitrogen. The empirical formula of the rapeseed straw stalk was $CH_{1.37}O_{0.71}N_{0.01}$, while the lower heating value of the rapeseed straw stalk was 16.37 MJ/kg. So it was concluded that within the biomass energy technologies, the straw stalk of rapeseed plant will be evaluated directly and with conversion processes.

Kennedy (2006) carried out the experiments on silver oak wood chips. The result of the ultimate and proximate analysis of wood chip is shown in following table.

Table 2.3 Proximate and ultimate analysis of wood chip

Proximate analysis	Percentage
Moisture	7.15
Ash	2.04
Volatile matter	82.56
Fixed carbon	8.25
Ultimate analysis	Percentage
Carbon	42.55
Hydrogen	4.22
Oxygen	43.65
Nitrogen	0.33
Sulphur	0.06
Gross calorific value kJ /kg	16052

Parikh *et. al.* (1989) reported results on the performance of a downdraft gasifier engine system. The biomass used was leuceana leucocephala. Proximate analysis (dry basis) reported, volatile matter 79.9%, fixed carbon 18.9% and ash content 1.13%.

Rajvanshi and Joshi (1989) reported that leucaena leucocephala was a leguminous fast growing tree species which was being popularized in India for energy plantation. Calorific value of wood was 17.6-18.4 MJ kg⁻¹, true density was 700-720 kg/m³. bulk density was 200-220 kg/m³ and ash content was 1-2%.

Sirisomboon (1991) developed correlation models relating to anhydrous high heating value to some proximate compositions, ash and volatile matter of biomass. Proximate analysis of eucalyptus, leuceana leucocephala and acacia auriculiformis are as follows:

Table 2.4 Proximate Analysis of Eucalyptus, Leuceana Leucocephala and Acaciaauriculiformis

Biomass	M.C (W.B)	Ash (%)	V.C (%)	Fixed carbon (%)	HHV (MJ kg ⁻¹)
Eucalyptus	7.13	4.41	67.44	21.02	20.56
L. Leucocephala	7.29	2.42	63.86	26.43	21.31
A. Auriculiformis	10.85	1.11	69.06	18.98	16.77

Talib *et. al.* (1989) reported that the proximate analysis and heating value of the eucalyptus as follows; volatile matter –73.8%, ash content –5.54%, fixed carbon –16.1% and calorific value – 22.0 MJ/kg.

Van, (2003) experimented several biomass samples of soybean straw, dry corn stalks, wet corn stalks and dry alfalfa hay for compression test. The objectives of this experiment were to (i) define a relationship between bulk density and applied pressure for several samples of corn stalks, soybean straw, and alfalfa hay, and curve fit the results using Equation 1 that models biomass densification, and (ii) to observe similarities or differences in the values for the constants k and n due to differences in moisture or type of biomass.

$$\gamma = k (p^n) \quad \dots (1)$$

Where;

γ = bulk density, kg/m³

k = constant

p = pressure, kPa

n = exponential constant

During the experiment the biomass samples were characterized with an MTS Sintech 60/D Materials Testing Workstation using a 2224 N (500 lb) load cell and a crosshead movement of 12.7 cm (5") per minute. The samples were compressed within a PVC tube having a 39 cm (15.4") inside diameter and a 56 cm (22.0") height. In increasing order, the average k-value for each material tested was 25 (dry corn stalks), 36 (soybean straw), 49 (wet corn stalks) and 56 (dry alfalfa hay). The most difficult biomass material to compact, out of the four, was dry corn stalks. This experiment also indicates dry biomass was tougher to compact than wet biomass. In decreasing order, the average n-value for each material tested was 0.29 (dry corn stalks), 0.24 (soybean straw), 0.24 (wet corn stalks) and 0.23 (dry alfalfa hay) respectively. An ANOVA test determined that the k-values are statistically different for each material. However, an ANOVA test did not conclusively prove that the n-values of the different biomass materials are different.

Vimal and Bhatt (1989) reported that one of the main components for briquetting of biomass is removal of moisture. This was represented as P_{th} (kW) and given for an initial feed capacity K_i by

$$P_{th} = \frac{620 (F_i - F_f) K_i}{\eta_c \times 860}$$

Where F_i and F_f represents initial & final moisture content and η_c denotes conversion efficiency of chemical energy in wood to evaporate 1 kg of water respectively.

Yang *et. al.* (2006) reported on performance analysis of fixed bed biomass gasifier using high temperature air. The feedstock used for investigation was wood pellets. Feedstock properties reported was proximate analysis: moisture content 8.22 per

cent, ash content 0.4 per cent, low heat value 17.1 MJ/kg, volatile matter 83.9 per cent (dry), fixed carbon 15.7 per cent (dry). Ultimate analysis; sulphur was 0.04 per cent, carbon 50.4 per cent, hydrogen 6.2 per cent and oxygen 42.8 per cent.

2.4 Making of Briquette

Amaya *et. al.*, (2007) studied that for carbonaceous materials to conformed as pellets or briquettes, the process that involves mixing and pressing of char with adhesive materials prior to activation. In this work, the influence of the operation conditions on the mechanical and surface properties of briquettes was studied. Eucalyptus wood and rice husk from Uruguay were used as lignocellulosic raw materials, and concentrated grape must from Cuyo region-Argentina, as a binder. Different wood:rice and solid:binder ratios were used to prepare briquettes in order to study their influence on mechanical and surface properties of the final products.

Erickson and prior (1990) concluded that biomass densification means the use of some form of mechanical pressure to reduce the volume of vegetable matter and the conversion of this material to a solid form, which is easier to handle and store than the original material.

Jorapur and Rajvanshi (1995) found that about 15–28% by weight of the fuel was converted into char with a calorific value of 19 MJ kg⁻¹. This char, when mixed with a suitable binder and briquetted, formed an excellent fuel for wood stoves.

Karve *et. al.*, (2001) manufactured briquette from the char. The char is powdered by manually running a roller over it. It is then mixed with a binder. Paste of grain was used as binder. The paste is made by boiling the flour in water. One kg of the briquettable mixture contains approximately 900 gm of char and the paste of 100 gm of waste grain. It is made into dough by adding water. The mixture can be briquetted using any type of briquetting machine.

Saeidy and Mlynek (2004) found that the stable briquettes without binding material could be produced from cotton stalks and the other experimental materials. This depended on the material, sufficient pressure and suitable moisture content. This means that application of briquetting technology solved the environmental and storage problems of cotton stalks. The dilemma of contradictory laws for the disposal of cotton stalks in

Egypt could be overcome. The farmer's household could cover its need for fossil fuels for cooking and baking by using a renewable energy source. It was also found that the experimental material, cotton stalk was well suited for combustion. Increasing the pressure increases the briquette density and as a consequence the briquette durability also increases.

Sharma (2005) observed that bio-briquette is the product formed from the carbonization of organic materials. It consists of unburnt organic material, commonly called char which is ground or pulverized. Mixed the char with mud in the ratio of char to mud 3:1 by weight or 6:1 by volume and water; and is given a definite shape by putting in a molding-last. The shape commonly used in nepal is a circular one with holes in the middle, which looks like a bee-hive, so it is also commonly called as bee-hive briquette.

Singh *et. al.* (2006) studied the storage combustion and gasification behaviour of biomass briquettes made from groundnut shell powder (1180-150 μm) and briquettes made of saw dust and castor de-oiled cake. It was found that storage of briquettes through the high humidity period did not create any problem. However, with the increase of storage duration, ash content increased, resulting into decrease in calorific value of biomass briquettes. Combustion and gasification studies revealed that 25 and 35 mm diameter briquettes could be satisfactorily gasified in open core and throat type down draft gasifier reactors, but up draft reactor was not found suitable for gasification on continuous basis.

Toan *et. al.* (2004) stated that Vietnam has a high potential of agro-residues for producing energy, especially rice husk, rice straw, sawdust. The application of biomass briquetting technology e.g. transforming the loose biomass into briquettes was an effective way to overcome low density problem. Overall reduction of electricity consumption by the briquetting system was about 25% and lifetime of the briquetting screw increased to one shift of operation. A number of improved briquette stoves were also developed; these had high efficiency up to 30- 40%, and very low co emission factor compared to traditional stoves.

2.5 Briquetting Methods and Briquetting Machine

Andrzej and Waldemar (2006) analyzed the quality of briquettes produced by a mixture of wood particles, sawdust and dust using perpetual screw briquette machines with a heated mould matrix and the stability of the production process was further monitored. The moisture content and fractional composition of the waste products used for briquettes production along with the density and degree of pressing of briquettes was determined. The quality of briquettes assessed on the basis of the macroscopic structure and physical parameters was very good. The density was close to $1200 \text{ kg}\cdot\text{m}^{-3}$, the moisture content of about 3%, with smooth external surface and homogeneous cross-section structure. The good quality briquettes were characterized by proportional contribution of particular fractions of the lignocelluloses blend. The most important reason for the instability of briquette production process was found to be inhomogeneous distribution of wood dust and not its fractional size in the bulk of the lignocellulosic mass introduced into the briquetting machine.

Anon (2003) published a manual for introduction of some briquetting machine and stove prototypes which were designed and developed by the Institute of Energy under the scope of the project “Renewable Energy Technologies in Asia (RETs in Asia)”, a Regional Research and Dissemination Programme. The objective of the manual was to provide information, technical parameters, and detailed drawings helping localities and enterprises in manufacture, construction of biomass briquetting system and improved stoves. This manual consists of two main sections: i) improved biomass briquetting system including briquetting machine, preheater and die heater and ii) improved briquetting stoves.

Bellinger and McColly (1961) used a cylinder of closed die form to calculate the compression and ejection energy of pellets of dry alfalfa and reported the compression plus ejection energy range as 2.7 to 8.2 hp-h/ton (13.03 to 39.57 J/g).

Bhattacharya and Kumar (2005) presented a booklet document titled “Technology Packages” developed by the Biomass Briquetting Group of RETs in Asia consisting of Asian Institute of Technology (AIT) and three NRIs. The participating NRIs were the

Institute of Energy (IE), Vietnam; Khulna University of Engineering and Technology (KUET), Bangladesh (formerly Bangladesh Institute of Technology (BIT)) and the Royal Nepal Academy of Science and Technology (RONAST), Nepal. Four packages were developed at AIT, which included one complete heated-die, screw-press biomass briquetting system and three gasifier stoves, which could use biomass briquettes as fuel. NRIs developed their own briquetting systems adapting the generic design to their specific country's requirements and also developed several briquette-fired stoves.

Bhattacharya *et. al.* (1990) found that the ICS programs in most developing countries of the world led to dissemination of improved cooking stoves (ICS) so as to relieve pressure on biomass resources. Most of the ICS programs were directed towards development of improved household cooking stoves, while relatively less work had been done on development of bigger stoves that could be used in institutional kitchens or certain traditional rural cottage industries. Three different designs of such stoves, using biomass briquettes as fuel, had been studied.

Bhattacharya *et. al.* (2002) conducted experiments on a heated-die screw-press briquetting machine. Average savings in the electrical energy consumption due to pre-heating were 23.5 % at heater and 10.8 % at motor respectively. The average total energy saving was about 10.2 %. The lowest electrical energy consumption for rice-husk was 0.172 and 0.150 kWh/kg of briquettes produced, without and with pre-heating respectively. The biomass stove developed for die-heating was found to perform satisfactorily, and requires periodical fuel loading and ash-scraping. The stove could heat the die to the required temperature range of 300-320°C for briquetting during continuous operation. Average electrical energy saving due to replacement of electrical heaters with the biomass stove for die-heating was estimated to be about 35 % of total electrical energy consumption.

Bhattacharya *et. al.* (2002) investigated the effects of different parameters on performance and emissions of three biomass-fired stoves. The parameters considered were moisture content of fuel, size of fuel, size of pot and method of ignition, while the selected stoves were an improved Indian stove, a Vietnamese traditional stove and an improved stove developed by the Royal Thai Forestry Department. It was found that

increase in fuel moisture content resulted in decrease in stove efficiency, increase in the emission factor of CO and decrease in the emission factor of NO_x. A slight decrease in CO₂ emission factor was also observed, while emission of CH₄ was not significantly affected. The fuel size did not have any significant influence on the efficiency of the stove; however, it showed significant influence on the emission of CO for the size range investigated. The size of pan did not affect the efficiency of the stoves tested. Two methods of stove ignition conventional bottom ignition and top ignition were investigated. In general, emission of CO and NO_x was significantly less in case of top ignition in comparison with conventional bottom ignition.

Brandt (1988) conducted a survey of 60 briquetting machine manufacturers in several parts of world. According to him a wide range of equipments were needed to operate a plant effectively. During World War II, briquetting of saw dust and other waste materials was very common in Europe and America under the impact of fuel shortage. Japan also faced dire need of briquetted fuel and the work was initiated to modify screw machine. The technology was common until recently and spread to Taiwan. It was also reported that in Thailand, the screw technology reached originally from Taiwan and there were three manufacturers of briquetting equipment. The average cost of machine was \$1000.

Demirbas and Simsek (2006) in their investigation reported the utilization of Aniline (C₆H₇N) Formaldehyde (HCHO) resin as a binding agent of coke briquetting. Aniline Formaldehyde resins were a family of thermoplastics synthesized by condensing Aniline and Formaldehyde in an acid solution exhibiting high dielectric strength. The tensile strength sharply increased as the ratio of Formaldehyde to Aniline increased from 0.5 to 1.6, reached the highest value between 1.6 and 2.2 and then decreased slightly.

Demirbas *et. al.* (2004) studied some briquetting properties such as moisture content, shatter index, compressive strength, water resistance, heating value and combustion of briquettes from pulping reject and spruce wood sawdust. The strongest briquettes (shatter index 20500, compressive strength 49.5 MPa) produced using spruce wood sawdust was achieved with a moisture content of 15% at a briquetting pressure of 350 MPa. The effect of the moisture content on the compressive strength and the shatter

index of the briquette samples from pulping reject and spruce sawdust were studied. The results suggest that as the moisture content of the briquette samples increased significantly, the compressive strength and shatter index of the briquettes also increased.

Eriksson and Prior (1990) stated biomass densification as a process of applying some form of mechanical pressure to reduce the volume of vegetable matter and the conversion of this material to a solid form, which is easier to handle and store than the original material. The use of organic briquettes mainly in industry was revitalized during the oil crisis of 70s, and early 80s especially in Scandinavia, USA and Canada.

Fabienne *et. al.* (2006) tested and evaluated several methods and procedures for the determination of particle density of pellets and briquettes. Round robin trials were organized involving five European laboratories, which measured the particle densities of 15 pellet and five briquette types. The test included stereo metric methods, methods based on liquid displacement (hydrostatic and buoyancy) applying different procedures and one method based on solid displacement. From the results for both pellets and briquettes, it became clear that the application of a method based on either liquid or solid displacement (only tested on pellet samples) leads to an improved reproducibility compared to a stereo metric method. For both, pellets and briquettes, the variability of measurements strongly depends on the fuel type itself. For briquettes, the three methods tested based on liquid displacement lead to similar results. A coating of the samples with paraffin did not improve the repeatability and the reproducibility. Determinations with pellets proved to be most reliable when the buoyancy method was applied using a-wetting agent to reduce surface tensions without sample coating. This method gave the best values for repeatability and reproducibility, thus less replications are required to reach a given accuracy level. For wood pellets, the method based on solid displacement gave better values of repeatability; however, this instrument was tested at only one laboratory.

Granada *et. al.* (2002) described the process of designing a taper die and its optimization for use in a hydraulic machine. The application of an experimental design technique and the statistical analysis of the results were presented, applied to a laboratory hydraulic press densification process of lignocellulosic biomass. The most appropriate experiment type was determined for a first set of experiments; calculating, among other



Missing pages
21 = P.

Munoz-Hernandez *et. al.* (2006) highlighted problems in Mexico and most developing countries during dry seasons, due to shortage of forage which may cause economic losses to cattlemen. But, Mexico produces about 60 million tons of agricultural crop residues every year. An interesting use for these residues was to produce animal feed after harvesting as an efficient alternative to cattle feed. Some handling problems are associated with the low density of these materials, such as storage and transportation. In order to solve these problems, the densification process was proposed as a solution. However, before selecting or designing any commercial machine, it was necessary to know the mechanical behavior of the material and the processing conditions. The main objective of this work was to present an easy laboratory method to find optimal conditions of the densification process for producing animal feed. The studied material was a sheep feed, which consisted mainly of alfalfa hay and corn crop residues. An open-end die was used to simulate the extrusion process. A Box Behnken design was run in the laboratory to find the best levels of the factors (moisture content, temperature and die length) on the responses (extrusion pressure, pellet density, and specific energy consumption). Afterwards, three runs were developed in the laboratory to confirm the optimum results. Also, same levels of the factors were used on real scale single-screw extruder to confirm the laboratory results.

Purohit *et. al.* (2006) stated that the suitability of using biomass briquettes to substitute coal was debatable, as a substantial amount of energy was required for briquetting of biomass. In the present work, an attempt to evaluate the energetic viability of briquetting of agricultural residues compared with the energy embodied in coal in India has been made. Briquetting of agricultural residues was not found to be an energetically viable option even for locations at a distance of about 1500 km from the coal pithead (even if the briquetting unit was located very close to the place of availability of the agricultural residues). A need for transportation of agricultural residues further pushed this critical distance upwards.

Reed and Bryant (1978) presented the state-of-the-art evaluation of densified biomass fuel. This was the first comprehensive documentation of process, energy balance, economics and applications.

Reed *et. al.* (1980) in their experimental results showed that the specific power consumptions decreased up to 50% by preheating the material from 100 °C to 225°C. But very high temperature could produce degradation on feed constituents. So, degradation of the feed nutrients has to be considered in future studies.

Saeidy and Mlynek (2004) found that the stable briquettes without binding material could be produced from cotton stalks and other experimental materials. This was dependent on the material properties, sufficient pressure and suitable moisture content. This means that application of briquetting technology solved the environmental and storage problems of cotton stalks. The dilemma of contradictory laws for the disposal of cotton stalks in Egypt could be overcome. The farmer's household could cover its need for fossil fuels for cooking and baking by using a renewable energy source. It was also found that the experimental material, i.e. cotton stalk was well suited for combustion. The ecologically and firing-relevant material content, the ash content and the heating value was within the range of usual solid bio-fuels (volatile components: 66-75%; sulphur: 0.1-0.25; nitrogen: 0.6-0.9%; chlorine; 60-4400 mg/kg; ash 1.7- 4.8%; lower heating value: 17.5 -19.4 MJ/kg). The high value of the chlorine (4400 mg/kg) and ash content (4.8%) of the cotton stalks was within the range of non-woody bio-fuels. Increasing the pressure increases the briquette density and as a consequence the briquette durability also increases. The dry matter density and the radial compressive strength generally increased with the increase in moisture content of the material. With increased pressure the briquette density increases digressively and its radial compressive strength progressively.

Sathitruangsak *et. al.* (2006) carried out study with an objective to design an extrusion screw to produce biomass solid fuel in a cold extrusion process and investigated the effects of molasses used as a selected adhesive on the physical properties of extruded products. The material consisted of crushed coconut shell char and coconut fibre char mixed at a ratio of 40:60. The ratios of molasses in the mixture were 10:100, 15:100 and 20:100 (by weight) and the extrusion die angles were 1.0, 1.1, 1.2, and 1.3 degrees gradation per experiment. The experimental results showed that the newly designed screw could function properly in the output range of 0.75-0.90 kg/min, which

was close to the design value. Regarding the molasses's effect on solid fuel properties, increasing the share of molasses was positive for both output and strength of the resulting briquettes, whereas the results of increasing die angle showed decrease in both output and strength. The compressive strength varied between 2.49-2.87 MPa in all circumstances, which was considerably higher than acceptable industrial level. Furthermore, the extruded solid fuel showed excellent resistance to impact force. Regarding energy consumption, the amount of electrical energy used in the extrusion process was insignificant, ranging between 0.040-0.079 kWh/kg.

Singh *et. al.* (2006) studied the storage combustion and gasification behaviour of biomass briquettes made from groundnut shell powder (1180-150 μm) and briquettes made of saw dust and castor de-oiled cake. It was found that storage of briquettes through the high humidity period did not create any problem. However, with the increase of storage duration, ash content increased, resulting into decrease in calorific value of biomass briquettes. Combustion and gasification studies revealed that 25 and 35 mm diameter briquettes could be satisfactorily gasified in open core and throat type down draft gasifier reactors, but up draft reactor was not found suitable for gasification on continuous basis.

Srivastava *et. al.* (1986 a) quoted that probably first briquetting machine was fabricated in 1920. It was a special press which produced cylindrical briquettes of 76 mm diameter and 254 mm height. They reported that in 1940, during early world war, almost every household in Switzerland owned a small briquetting press for pressing water soaked news prints.

Steverson *et. al.* (1985) showed the necessity of experimental research in making densified fuels derived from trash and that the use of binders was not always economic. Die length is a factor with limited information in literature, but commercial information from California Pellet Mill (CPM), shows die length (die thickness) from 63.5 mm to 76.2 mm, for holes of 6.35 mm (1/4") and light-bulk materials. Light-bulk materials are dairy feeds with low protein and low grain. It was about twice the value obtained in this work and this pelletizer was also designed to control temperature and pressure.

Tadtiyanant *et. al.* (1993) performed the extrusion of dead poultry and residues with a single screw extruder of orifice size 9 mm; screw speed 550 rpm and feed rate 819 kg/h. The internal temperature of the barrel ranged from 148 to 160 °C at the point of extrusion.

Toan and Cuong (2000) reported study of a briquetting machine which was imported from Thailand and tested extensively with local raw materials. Screw design was found to be an area requiring major design improvements. Several experiments were conducted with different screw designs, and an optimum design was developed. A problem concerning screw life was studied to enhance the operating life of screws. Prototype briquetting machines were also fabricated, after adaptive research. Briquetting technology was demonstrated at several demonstration centres in the country, to disseminate the concept among general public and training programmes were conducted for prospective entrepreneurs and technicians. Improved briquette-burning domestic stoves were also developed by the Institute of Energy in collaboration with AIT, for dissemination together with the briquetting machines.

Toan *et. al.* (2004) stated that Vietnam has a high potential of agro-residues for producing energy, especially rice husk, rice straw, sawdust, etc. However, the energy use of the residues in raw form was still limited due to certain disadvantages, particularly low bulk density. The application of biomass briquetting technology e.g. transforming the loose biomass into briquettes was an effective way to overcome this problem. Under the framework of Renewable Energy Technologies in Asia (RETs in Asia) programme sponsored by the Swedish International Cooperation Development Agency (Sida), and coordinated by the Asian Institute of Technology (AIT), the Institute of Energy (IE), Vietnam carried out research aimed at improvement and development of heated-die screw-press biomass briquetting system and briquette-fired stoves. Research on improvement of the briquetting system involved biomass preheating; optimization of screw design and its fabrication method using wear resistant material for hard-facing the screw flights; increasing diameter of briquettes; using an electric motor of lower capacity and substitution of electrical heater by a solid-fuel fired stove for heating the die of the briquetting machine. Overall reduction of electricity consumption by the briquetting

system was about 25%, and lifetime of the briquetting screw increased to one shift of operation. A number of improved briquette stoves were also developed having high efficiency upto 30- 40% and very low CO emission factor compared to traditional stoves.

Wilaipon (2002) investigated the maize cob briquetting process. Raw materials used were maize cob and molasses, as the briquette binder. The die pressure range was limited to a modest one, less than 15 MPa. Several factors, which are the percentage of relaxation in length, the percentage of increased volume, the impact resistant index, the percentage of weight loss and the water resistance, had been examined. It was found that the final percentages of relaxation in length and increased volume after 96 hours exposure to the laboratory atmosphere were in the range of 15 -18% and 20 -28 % respectively. All briquettes produced showed the great results on the impact resistance test. Nonetheless, for the case of water resistant investigation, the dispersion times for all briquettes were less than one minute.

Zohns and Jenkins (1986), Esaki *et al.* (1986), Faborode and O'Callaghan (1986) also have carried out experiments with closed dies in the laboratory.

There are several methods used for compaction of biomass using different types of briquetting machines. These are classified as follows:

- i. Manually operated Briquetting Machine.
- ii. Animal operated Briquetting Machine.
- iii. Power operated Briquetting Machine.

2.5.1 Manually operated machines

Brandt (1988) reported that wet material without binder, such as coir dust could be briquetted without densification, manually, with density of 0.5-0.7 kg m⁻³. This process could also be used for briquetting of fine material but with some binder. The binding material such as sludge could be used for rice husk, etc. The agglomeration principle could also be used for briquetting of fine mass, up to density of 0.5-0.7 kg m⁻³. The material with binder was fed into a rotating drum. The balls were formed due to motion of drum and came out. The process had been reported to be used in Sudan. (Fig. 2.1)

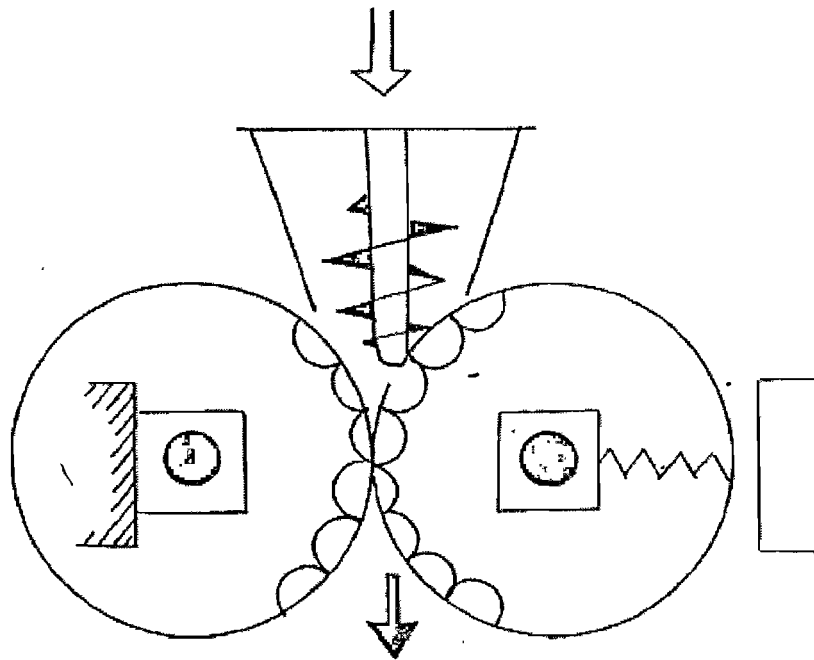

Fig. 2.1 Technique of Briquetting of Fine Mass

Mathur *et. al.*, (1991) also designed and fabricated hand operated and pedal operated pellet making machines (Fig. 2.2 and 2.3) of capacity 12 kg/h and 30 kg/h respectively. Both the machines could be operated by one man and were suitable for carbonized biomass, saw dust, rice husk and straw. The machines used cow dung slurry as binder material.

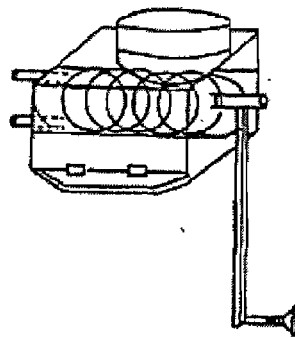

Fig. 2.2 Hand Operated Briquetting Machine

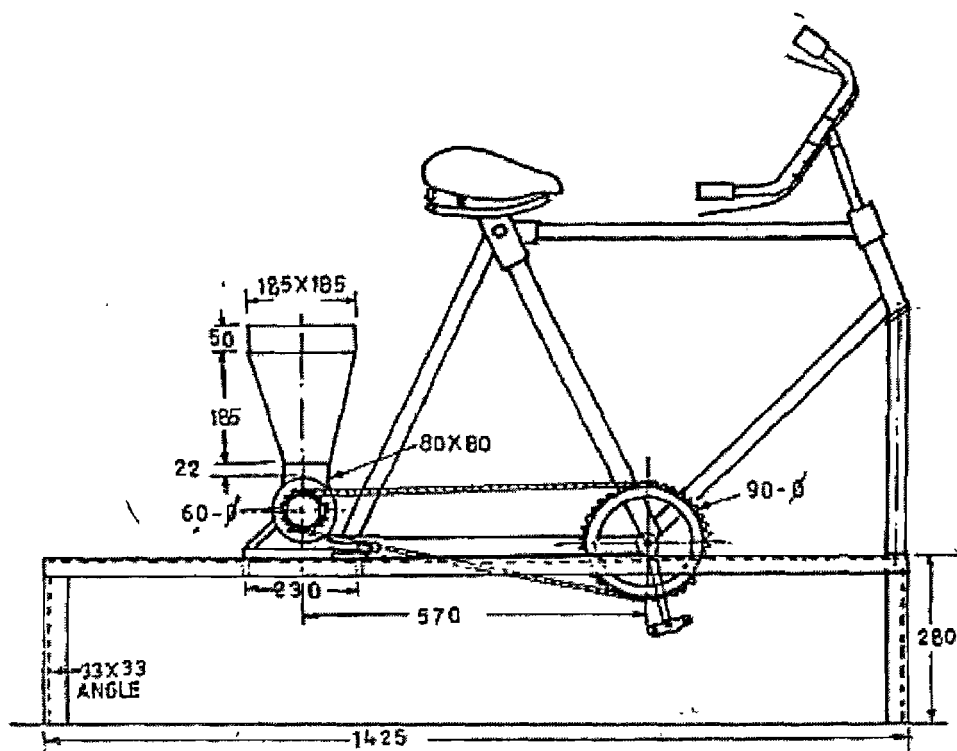

Fig. 2.3 Pedal Operated Briquetting Machine

Singhal (1987 a) reported that the School of Applied Research, Vishrambag, Sangli, Maharashtra developed two version of hand operated presses of capacity 5 kg/h and 20-50 kg/day. It used screw and nut arrangement or flywheel with crank slider mechanism. The machine had a die of 300 mm diameter. They produced the machine for commercial sales.

Srivastava *et. al.* (1986 b) reported a laboratory model of machine costing at Rs. 350/- and producing briquettes @ 20 kg/h developed at JNKVV Jabalpur. This machine was operated by one man.

2.5.2 Animal operated briquetting machine

Simple briquetting machines using wet principles of palletisation could be operated by animal power.

Mathur *et. al.* (1991) reported paddle operated briquetting machine to operate on animal power with some modification in drive. This machine produced briquettes with a density of 0.6-0.75 kg m⁻³ which was reasonably good to give improved combustion characteristics.

Srivastava *et. al.* (1986 a) reported that SAR Sangli developed a Singal bullock operated machine of 30 kg/h capacity. Though the cost of machine was not much, yet it primarily palletised the mixture instead of densifying.

Singhal (1987) then developed and commercially produced bullock operated briquetting machine with capacity of 100 kg/day. Practical utility of this machine was not advocated widespread. It remained a system of academic interest and not accepted at pilot level.

2.5.3 Power operated briquetting machine

Brandt (1988) reported that the power operated briquetting machine could be of mechanical press screw extruder type. Three hundred such units were reported operational in Brazil. An Indian manufacturer also sold few such plants. These plants were reported to be working with trouble. There were few pilot plants based on this technology in Africa, whereas, there was no report from South East Asia. A number of locally manufactured machines had been reported to be operational in India and many parts of the world. An Ireland based manufacturer was active for several years, though, he did not supply any machine in Asian countries.

According to Grover (1990), the modern mechanical piston briquetting machine was developed in Switzerland based on technology developed in Germany in 30s. Chemical Engineering Department of IIT, Delhi developed a process of char briquetting. The process of "PARU" fuel manufacturing was shown in fig. 2.4. The char was crushed to about 3 mm size and then briquetted using extruder or press. The briquettes were dried using rice husk fired furnace. The PARU fuel was reported to be smokeless and was ideally suited for domestic use with average calorific value of about 3400 k cal/ kg. Since then there have been widespread use of briquettes made from brown coal peat and coal fines. Power operated machines are classified as follows:

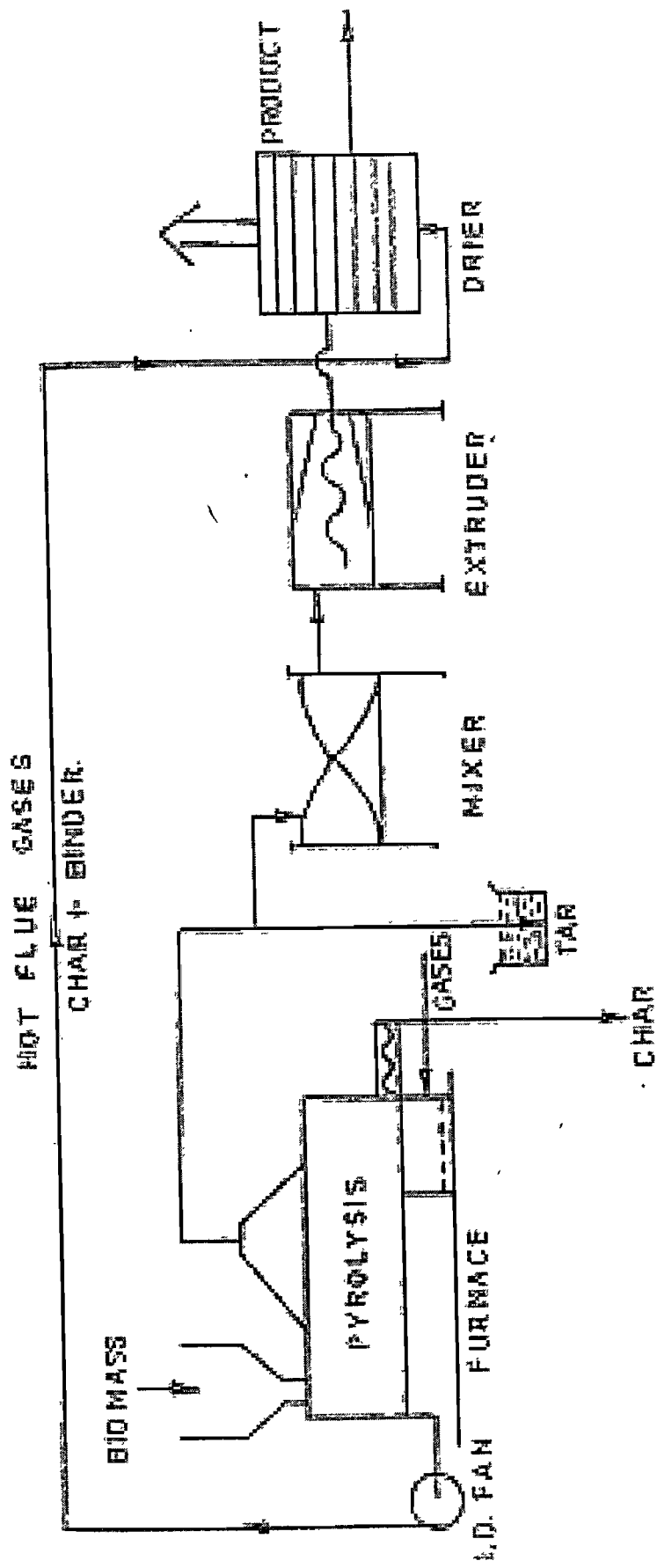

Fig. 2.4 PARU Briquetting Technique

2.5.3.1 Roller press

The briquetting of organic materials required significantly higher pressures. The additional force was required to overcome the natural springiness of these materials. It could be achieved by destruction of some cell walls through combination of pressure and heat. The need of higher pressure means that the briquetting of organic materials was inherently more costly than for inorganic fuels.

Eriksson and Prior (1990) concluded that the roller press using only moderate pressure and a binder was most common technique used in fuel briquetting. This type of plant was used to make all kinds of fuel and non-fuel briquettes from inorganic material such as coal. Various binders were used; one of the most common was lignin derived from pulp and paper mill.

Gunter and Nache (1984) mentioned that rollers and perforated dies were important elements for the palleting press. The compaction took place in the open working holes of the die. The coarse crushed material was fed into the press vertically from above and formed a pad on the surface of the die. The rollers moved over this layer of material and compact it. The pressure was continuously increased (Fig. 2.5) whilst the material rolled toward working hole, thus pushing the material in the cylinder slightly forward. To make this possible the friction of the pellets inside the working hole should not exceed the effective forces of pressure of the rollers.

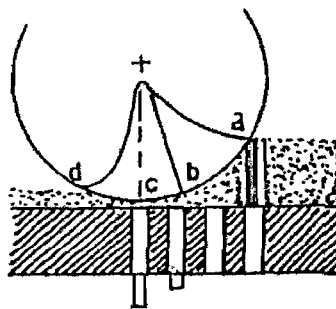

Low of Pressure with Rollers Running over a Working Hole.

Fig. 2.5 Roller Press Briquetting machine

2.5.3.2 Piston press

Brandt (1988) reported that the mechanical drive piston press type machines were of capacity between 300-3000 kg/h. The technology was rather complicated especially with regards to bearing of the crankshaft, and piston rod. The high investment and operating costs and high raw material requirement with transport of fuel over long distances made the process uneconomical.

Choudhary (1986) reported that he began manufacturing of these machines in India under license from M/s. Hausmann through M/s Ametep Industries, Faridabad. Mechanical presses produced hard and dense briquettes from most materials whilst hydraulic presses, which worked at lower pressure, produced briquettes which were less dense and sometimes soft and friable. The hydraulic drive piston presses were similar to mechanical press except drive system. The entire machines were much less cumbersome than flywheel driven mechanical piston presses.

Eriksson and Prior (1990) indicated that the piston press acted in a discontinuous manner with material being fed into a cylinder which was then compressed by a piston into a slightly tapering die. The compressed material was heated by frictional forces as it passed through the die. The compacted briquettes broke into pieces 10-30 cm. long. Piston presses with hydraulic drives were reported to be suitable for soft materials like paper, card board, manure, etc.

Grover (1990) performed study on six machines working on Hausmann technology imported during 1982-86 and installed two each at Alternate Energy Sources Centre, Pondicherry, Solar Sciences at Nalagarh Himachal Pradesh in 1984-85 and one each at Bio Solar (P) Ltd. at Delhi and Kichha. Only one machine was reportedly working presently.

Grover (2004) developed a machines which had a capacity of 400 kg/h working on binderless process. The machine found good use in India and most of Indian manufacturers adopted this design. This reciprocating motion type design did not work well due to many problems including R & D input, back up support and ultimately all machines became out of use, main problems being of die and ram .

Srivastava *et. al.* (1986) reported that the piston presses with mechanical power needed proper shaped die for a raw material. Maintenance cost mostly involved replacement of die in every few hundred hours. Materials like rice-husk, straw, corn cob, etc. may abrade die quickly. Some low pressure piston machine may not be able to generate sufficient heat and a binding material may be necessary to form briquette. The diameter of the briquettes influenced the output of the machine, however, this relationship was observed to be inflexible. Piston presses could be driven either by mechanical means from a massive flywheel via a crankshaft or hydraulically. The mechanical machines usually larger ranging in size from 0.45 to 0.3 tones/ h. While hydraulic machine normally ranged up to 0.25 tones / h though some larger models were available.

Vimal and Bhatt (1989) described the presently used mechanical piston press. These were developed around Fred Hausmann and Glomera Press, though; they were not the original inventors. Hausmann undoubtedly played an important role in making the technology well known all over the world.

2.5.3.3 Screw press

Car *et. al.* (1984) reported that straw was successfully compressed to form briquette or pellets in USA to be used as fodder, additives and fuel, using screw or piston press. In palletization ring or flat die presses were used. The material was extruded through a perforated breaker plate and the products were small cylinders 6-22 mm in diameter. The palletization had advantages of higher out put between 4-6 tones/h. Wide range of moisture content could be accepted (up to 20 per cent wb) with a more convenient operation. However, the mean straw length must be less than 25 mm.

Eriksson and Prior, (1990) found that the maintenance cost of screw presses was high due to higher wear of screw, which needed frequent rebuilt. If the heating of die was to be avoided, the binding by lignin flow will not take place and a separate binder would be needed. The earliest development work on screw presses was carried out in USA in the 1930's resulting in the widespread use of the PRES-TO-LOG model which was based on the conical type of screw extruder (Fig. 2.6). The Belgian Biomat design also used conical extruder. A

Japanese design developed in World War II used heated die and a prolonged tapered central shaft of the screw resulting in a hollow briquette. It was very successful and a manufacturer claimed to have sold 600 such units.

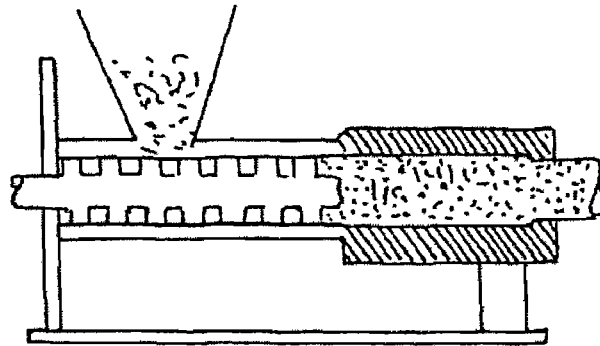

Fig. 2.6 Conical Extruder Screw

Gunter *and*. Nache (1984) reported that only suitable method of compacting biomass was the extrusion agglomeration process which could be applied in different ways, depending upon the characteristics of the raw material for making pellets from coarse materials with low bulk density and bad flow characteristics, the extrusion press with flat dies had been proved to be universally applicable.

In Japan, briquetting seemed to have been common until recently with widespread use of Ogalite fuel briquettes made of saw dust. The Japanese technology has spread to Taiwan and from there to other countries and Thailand. This technology was based on screw press principle (Fig. 2.7).

Srivastava¹ *et. al.* (1986) studied that in the screw presses, material fed continuously into a screw which forced it into a cylindrical die. The die was often heated to raise the temperature to the point where lignin flow occurred. The pressure built up smoothly along the screw rather than discontinuously under the impact of piston. Screw presses could be of the capacity 75-250 kg/h though larger machines were available.

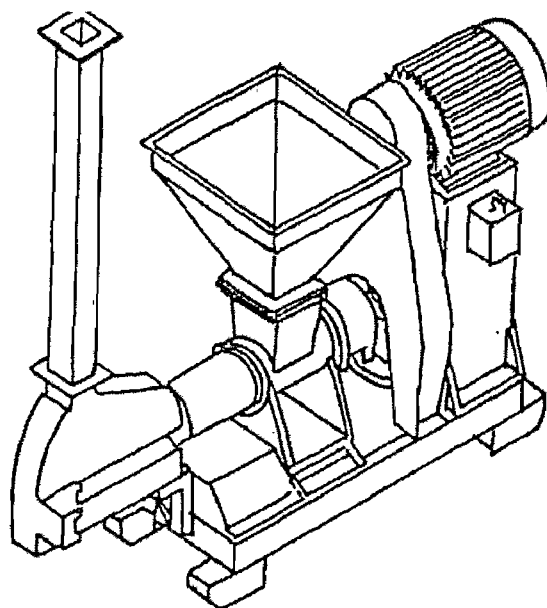

Fig 2.7 Screw Press Technology

Srivastava² *et. al.*, (1986) reported that the carbonized material could be briquetted in a screw press and in this, as lignin had been destroyed; a binder had to be employed. The capital cost of screw machines may be a little less than piston units; however, because of variation in capacities it was difficult to compare them directly.

2.6 State of arts of power operated briquetting plants

Choudhary (1986) reported that there were about 15-20 manufacturers of briquetting equipment, both for organic biomass and pyrolised char. During past few years many machines were sold / installed but most of them failed to attain desired goal for many reasons.

Grover (1990) reported that out of 70 plants sold by two countries, except 6-7, most of these plants became non-functional He also reported that not only briquetting plants stopped working but they resulted in discontinuation of manufacturing operations of these machines by 2-3 companies.

Gusain (1986) at Development Alternatives developed a hand operated ram type brick and briquette making press of capacity 500 to 800 kg briquette per day on 8 hour shift. The machine was a low cost model, priced at Rs. 10,000/- and handled both raw and pyrolysed biomass. The principle used was same as used in making soil blocks for bricks making. It used impact compaction and in each stroke it could make 24 briquettes of 3.8 x 3.8 x 5.4

cm size. The machine manufactured under trade name of "BALRAM" did not find market as the process of handling materials was highly labour consuming and slow.

Isaac and Bolufawi (2009) stated that for the densification of guinea corn residue, a source of biomass material is necessary for the purpose of handling and space requirements. The plant part of the guinea corn residue was collected from the field at a moisture content of 9.08% dry basis (db), reduced and sieved into three particle sizes d_1 , d_2 ; and d_3 . Starch mutillage of 40, 45, 50 and 55% by weight of the residue was added as binder. The bulk density of the unprocessed and processed guinea corn residue was determined using ASAE standards. Briquettes were produced using hydraulic press and a cylindrical die (56 mm ϕ) at pressures of 7.5, 8.5, 9.5 and 10.5 MPa. The particle sizes were separated into three distinct size ranges of 4.7 mm (d_1), 1.7 mm (d_2) and 0.6 mm (d_3). The mean moisture content of the relaxed briquettes was 7.15% (db). The bulk density of the unprocessed material was 46.03 kg/m³, and the mean relaxed briquettes bulk density was 208.15 kg/m³ with a volume reduction of about 450%. The maximum density of the briquettes ranged from 789 to 1372 kg/m³. The maximum and minimum axial relaxation occurred in the first 30 minutes of the extrusion with values 138.64 and 28% respectively in the longitudinal axis, the maximum and minimum radial relaxation were 11.5 and 1.4% respectively. The briquettes were kept safely for a period of six months without deterioration.

Juri Olt and Mihkel Laur (2009), analyzed the features of producing briquette from different herbaceous biomaterial and cardboard waste and describe the problems that can arise in the pressing operation. The screw press was used. The proper briquette was formed from wheat straw, rye straw and cardboard and the satisfactory one from rye straw together with meadow hay. While the rye straw briquette exhibited the highest calorific value and the lowest ash content, the leaf briquette had the highest ash content and the lowest calorific value.

Mohan (1986) and TIDE (1993) quoted that marketing of briquettes of a large scale commercial unit (more than one tone) had several problems such as regular availability of raw material, storage space, packing, marketing of product and levy of taxes by some of the governments, competitive price of firewood and high price of raw material.

Eriksson and Prior (1990) suggested that this is necessitated setting up of small scale unit using locally available or grown raw materials which could find market in and around villages.

Noordman (1992) confirmed that briquetting had immense potential in India but the existing plants were not doing very well.

Papneja (1986) felt need of development of appropriate briquetting machine and a model was developed at Prototype Development and Training Centre, Okhla, which used binder less technology working at a pressure of 1400 kg/cm². It used 22 kW power. The equipment could handle biomass which was dried, shredded and sieved to a particular size. Limited trials were conducted which showed that production dropped from 350 kg/hr to 290 kg/h¹ in 42 hours and quality of briquettes was also poor. The die, ring and punch, etc. was worn out within a short period. However, with use of high speed steel, wear rate was reduced by 50 per cent.

Rama Rao and Kodra (1986) reported that he installed a plant manufactured by M/s. Farm Implement Madras based on "PARU" technology of IIT Delhi. The output of pyroliser was only 50 per cent of rated output which was 4 tones out of 6 tones raw material. The machine designed for agricultural wastes, such as rice-husk, straw, groundnut shell, etc. was useful and all these materials found more profitable uses. However, there were frequent breakdowns of the unit.

Srivastava *et. al.* (1986) developed two prototypes of machines working on 2.2 kW and 3.70 kW power electrical motors keeping in view the requirement of a small scale briquetting unit for utilization in a village eco-system, where biomass of agricultural origin were available in scattered manner with small to large farmers and agro-based industries,. The small machine was used for agro- wastes with binding material such as clay etc. had a capacity of 50-60 kg/h. The other was charcoal briquetting machine of capacity 60-70 kg/h using charcoal and dung slurry. Though both machines were reported to be viable for cottage industries but they involved many manual operations and a vast variation in output. The sustained supply of wastes was not considered with machine.

TIDE (1993) quoted that before introduction of briquetting technology on commercial basis, no serious engineering, research and development efforts were made.

Vasudevan (1993) quoted that very few companies were manufacturing briquetting machines in country and they failed to solve user's problems, such as lubrication, wear etc. which needed to be solved as early as possible to avoid serious breakdowns of machine. He reported that the pyrolysis technology involving briquetting with a binder developed earlier in Delhi, attracted a large number of entrepreneurs but nearly 100 plants, which sprung up had to suspend their operations due to the various problems faced. Many financial corporations and banks lost a good deal of money and so also the entrepreneurs.

Yousif *et. al.* (2006) reported that briquetting of the carbonized agricultural residues represents one of the possible solutions to the local energy shortages in many developing countries. It constitutes a positive solution to the problem of increasing rates of desertification in many areas worldwide. Agricultural residues are not attractive as a household fuel source for urban areas because they are very bulky and have low energy intensity. Also, to eliminate the smoke generation when burning agricultural residues requires processing it by carbonization before being used as a house-hold indoor fuel. Previously investigated, briquetting machines lacked high productivity and were of complicated designs. The present study puts forward a machine of simple design which could be manufactured locally in Sudan and of much higher productivity. The local sudanese briquetting experience was overviewed, studying all the alternative available options and the market potential. The study presents a detailed design study of the new briquetting machine. The prototype was made and tested in the field at *al-gazeera* area in Sudan. The investigation results show that the new machine has a production rate better than all the previous alternatives. This low pressure screw briquetting machine was found to have a production rate equivalent to about eight times better than the production rate of the best local competitor. The production cost was found to be lower due to the lower binder requirement for the new machine, which is lower by about 65%. The initial moisture content of the feed stock required for this machine is lower by about 30 % compared to the best alternative, which results in shorter drying time for the fuel

briquettes produced. The quality of the produced briquettes was found to be better and of lower smoke generation when burned due to the lower binder content.

2.7 Economics

Anon (1999) reported that intense flame emitted from gasifier burner replaces conventional diesel fired burners in industries. The pay back period for 50000 kcal h⁻¹ thermal gasifier was 18 months and for 250000 kcal h⁻¹ was 12 months.

Jorapur and Rajvanshi (1997) evaluated the economics of a throat less down draft gasifier of rated capacity 1080 MJ h⁻¹ and the output of 675 MJ h⁻¹. The economics was more attractive for the gasification system.

Singh and Patil (2001) developed natural draft gasifier based water heating system. He found that net sum around Rs. 48,449/- and Rs. 60,984/- respectively. The payback period varies from 0.619 to 0.492 years and the benefit-cost ratio varies from 2.13 to 2.432.

Tripathi *et. al.* (1999) evaluated the unit cost of thermal energy for biomass gasifier-based institutional cooking systems and compared with that for LPG and coal-based institutional cooking options. It works out to Rs 0.37/MJ for a 29 kW_{th} (25 000 kcal/h) biomass gasifier system while for a 291 kW_{th} (250 000 kcal/h) system it is Rs 0.23/MJ. Biomass gasifier-based institutional cooking systems are always financially more attractive than corresponding coal-based systems and are even better than LPG based systems.

Review of the research work shows that there is need of development of briquetting technology which is feasible and economically viable. The present work was under taken after considering this all circumstances by developing a prototype briquetting machine of 150 kg/h capacity for farmers/individuals to utilized its own waste for production of efficient and eco-friendly fuel to satisfy energy need.

MATERIALS AND METHODS

An effort is made to study and estimate potential of different biomass available locally its present uses and problems in safe disposer in Rajasthan state. Further suitability of mustard stalk and its properties for briquetting, design of screw press briquetting machine for the same along with the properties of raw biomass and that of finally produced briquettes were also attempted. The economic analysis of the system was also carried out to determine the net present value, benefit cost ratio and payback of the system.

3.1 Property of Raw Mustard Stalk

3.1.1 Potential of different biomass in Rajasthan state

An agricultural residue is considered as one of the important surplus biomass in India, due to its vast agricultural base. Agricultural waste materials are highly volatile as compared to coal. The principal agricultural residues produced in Rajasthan state was wheat straw, rice husk and straw, residues from cotton, mustard, mehandi and arhar plantations, sugarcane and bagasses, stem, trash, ground nut shell and grass. The assessment of the potential of biomass was made available by analysing web site for the survey carried out in Rajasthan state, the Panchayati Raj and Vikas Darpan which is available online. On the basis of product to residue ratio for different biomass the total availability of biomass was estimated and presented in the next chapter. As per the high potential and easy availability in Rajasthan state mustard stalk as a one of the biomass residue was identified suitable for briquetting which was not used as fodder and any useful application.

3.1.2 Properties of mustard stalk

Assessment of the physio-chemical properties of mustard stalk for briquetting purpose was planned to evaluate its suitability. The TGA analysis of this biomass would be useful for its anticipated wider applications. Development of un-carbonized biomass briquetting for domestic uses using cheap biomass such as mustard stalks may be justified when appropriate devices for the production of the briquetted biomass were developed or made available in the country and the price of the product is competitive

with conventional fuel. Thus it was needed to utilize the mustard stalk waste in a suitable form which was easy to carry and store. There is a need to promote a technology to convert this loose mustard stalk waste in the form of solid fuel through the route of densification.

Properties of biomass like moisture content, bulk density, calorific value, angle of repose etc., were studied. These properties are more useful for designing of briquetting machine. The properties of mustard stalk shall give the idea about material used for briquetting (Karaosmanoglu *et al.* 1999, Bhattacharya *et al.* 2002). The details procedure to find out the characteristics of raw mustard stalk is followed by the guidelines given in text book of Biomass production and utilisation technology (Rathore *et al.* 2007)

3.1.2.1 Moisture content

The moisture content of a solid is defined as the quantity of water per unit mass of the wet solid. The moisture content plays an important role in the formation of briquette and subsequently its combustion. Moisture content of biomass at the time of harvesting varies drastically. The moisture content of biomass is measured by oven dry method. Initially the sample with the known weight is kept in oven at 105 °C for 24 hours (Plate 3.1). Then the oven dry sample is weighed (Browning, 1967). The moisture content of sample is calculated by following formula.

$$\text{M.C.} = \frac{W_1 - W_2}{W_1} \times 100 \quad \dots \text{(Eq. 1)}$$

Where, W_1 = Weight of sample before drying

W_2 = Weight of sample after drying

3.1.2.2 Bulk density

The bulk density of mustard stalk was determined according to BSI 3424 standard. A cylindrically shaped container with a diameter of known volume was used for this process. The container was weighed empty to determine its mass. Then it was filled with the sample and weighed once again. This process was repeated for 3-5 times. The bulk density was calculated by dividing the average mass of the material by the volume of the container (Karaosmanoglu *et al.* 1999).

3.1.2.3 Calorific Value

Calorific value is the amount of heat energy evolved by burning unit mass of fuel. This is most important parameter of biomass in the point of view of energy conversion. According to the ASTM D 3286 standard, the Bomb calorimeter was used for determination of calorific value of the biomass (Plate 3.2). One gram of biomass in the form of small pellet was placed in a closed bomb and the bomb was filled with oxygen at pressure of 25 atm and placed in the bucket full of water. The bomb get ignite with the help of nickel wire by supplying electricity. The initial temperature of water was noted and than the change in temperature was recorded for continuous 20 minutes with an interval of one minute. The maximum temperature rise was used for calculating the heat of combustion of sample, mathematically it is represented as.

$$H = \frac{W \times t}{m} \quad \dots \text{(Eq. 2)}$$

Where, W = Water equivalent of calorimeter, Cal/ °C

t = Rise in temperature, °C

H = Calorific value of fuel (Heat of combustion of material), Cal/gm

m = Mass of sample burnt, gm

3.1.2.4 Angle of repose

The angle of repose is the angle between the base and the slope of the cone formed on a free vertical fall of the granular material to a horizontal plane. In other words this is the specific angle to the horizontal surface beneath the pile of biomass. This property of biomass is useful in the design of hopper. The slant provided in the hopper for free flow of material was the angle of repose of raw material. The setup for angle of repose was developed in the experimental work shop of 300×300×400mm dimensions with middle topless and bottomless cone of 300 mm height. The bottom diameter of cone was 120 mm. The base plate of 100 mm diameter was kept on the support given at the bottom and pile was formed by free fall of material on the plate. The measured height of the pile and diameter of the plate give the angle of repose of the material. The experimental setup for angle of repose is shown in Plate 3.3 below.



Plate 3.1 Electrical Oven



Plate 3.2 Bomb Calorimeter



Plate 3.3 Instrument for measurement of Angle of Repose



Plate 3.4 Instrument for determination of Static Coefficient of Friction

$$\theta = \tan^{-1} \frac{h}{d} \quad \dots \text{(Eq. 3)}$$

Where, θ = angle of repose.

h = height of pile.

d = diameter of disc.

3.1.2.5 Determination of static coefficient of friction

The ratio between the force of friction and the force normal to the surface of contact is termed as static coefficient of friction. Coefficient of friction is also given by the tangent of the angle of the inclined surface upon which the friction force tangential to the surface and the component of the weight normal to the surface are acting. The static coefficient of friction of mustard stalk was determined on five different materials, namely stainless steel, aluminium, galvanized iron, mild steel and plywood sheet. The tilting platform of 300 × 100 mm was fabricated in the work shop and used for experimentation. A topless and bottomless plastic cylinder of diameter 65 mm and height 40 mm was filled with the stalk and placed on the adjustable tilting surface. The box was raised slightly so that not to touch the surface. The structural surface with the box resting on it can be inclined gradually with a screw device until cylinder just started to slide down and the angle of tilt was read from a graduated scale. Plate 3.4 above shows the experimental setup for coefficient of friction.

$$\text{Coefficient of friction} = \tan \mu \quad \dots \text{(Eq. 4)}$$

Where, μ = Angle of tilt, degree

3.1.2.6 Proximate analysis

Study of proximate analysis of biomass was carried out for determination of volatile matter, fixed carbon content and ash content in the biomass. The ASTM D 3175, ASTM D 3172, ASTM D 3177 was used for study (Karaosmanoglu *et al.* 1999).

3.1.2.6.1 Volatile matter:

The weighed dried sample of biomass material was kept in the crucible covered with a lid and placed in a muffle furnace (Plate. 3.5) maintained at $900^{\circ} \pm 5^{\circ}\text{C}$. The crucible was taken out of oven after 6 minutes of heating. The crucible was cooled first

in air then inside desiccators and weighed again. Loss in weight was volatile matter on percentage basis. The thermometer used for measurement is shown in Plate 3.6.

$$\% \text{ of volatile matter} = \frac{\text{Loss in weight due to removal of volatile matter}}{\text{Weight of sample taken}} \times 100 \dots \text{(Eq. 5)}$$

3.1.2.6.2 Ash content:

The residual material in the crucible was then heated without lid in a muffle furnace at $700 \pm 50^{\circ}\text{C}$ for an hour. The crucible was then taken out, cooled first in air, then in desiccators and weighed. Heating, cooling and weighing is repeated till a constant weight is obtained. The residue was reported as ash on % basis.

$$\% \text{ of ash} = \frac{\text{Weight of ash left}}{\text{Weight of sample taken}} \times 100 \dots \text{(Eq. 6)}$$

3.1.2.6.3 Fixed carbon :

The fixed carbon content was the value obtained after subtracting the value of moisture content, volatile matter and ash content from the hundred percent for balancing the value.

$$\% \text{ of fixed carbon} = 100 - \% \text{ of (moisture + volatile matter + ash)} \dots \text{(Eq. 7)}$$

3.1.2.7 Chemical property of mustard stalk

The chemical property of mustard stalk like lignin was also determined for the study. Lignin is a very important chemical parameter of mustard stalk for consideration in preheating. Thus it is necessary to know the amount of lignin present in the mustard stalk so that one can decide the preheating temperature with the help of TGA analysis. Lignin concentration of mustard stalk was determined using the method of Goering and Van Soest (1970), which entails digestion in an acid detergent solution to remove cell content and hemicellulose, followed by 72 % sulphuric acid to remove cellulose and finally combustion to remove lignin. Ash content was taken as the residual material left after combustion of mustard stalk.

$$\text{Lignin, \%} = \frac{(\text{wt of oven dried residue} - \text{wt of ash})}{\text{Wt of oven dried sample taken}} \times 100 \dots \text{(Eq. 8)}$$

The process flow chart for quantification of lignin and cellulose is given as follows (Fig. 3.1):

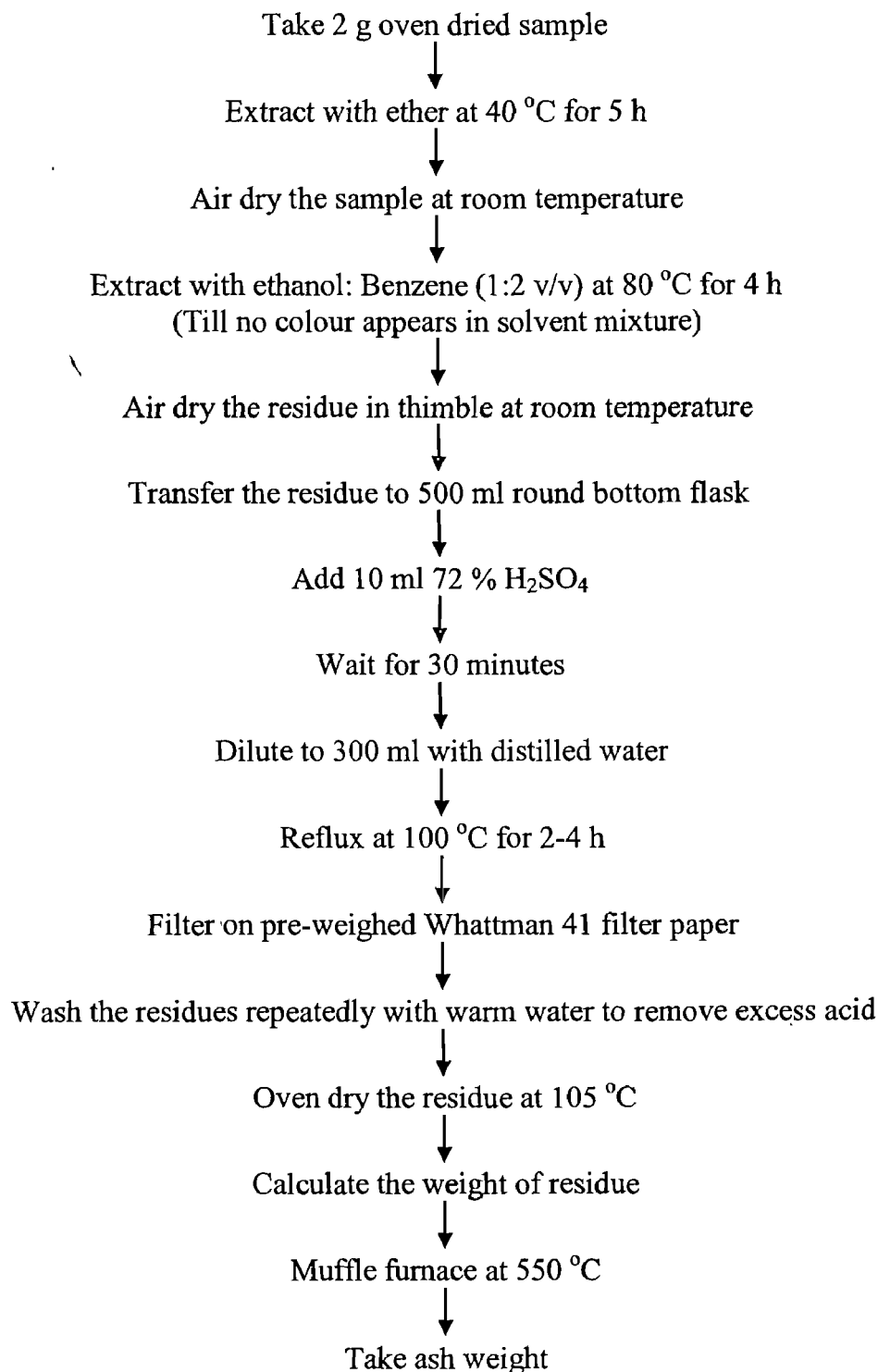

Fig. 3.1 Flow Chart for Quantification of Lignin



Plate 3.5 Muffle furnace



Plate 3.6 Non contacting thermometer

3.1.2.8 Thermo gravimetric analysis

The rate of devolatilisation of biomass can be determined by a standard Red Craft Thermo Gravimetric Analyser (TGA) (Plate 3.7). The TGA has a furnace with linear heating rate as 4°C per minute. Also, in this unit, a desired gas flow over the sample can also be maintained. Generally N₂ gas at a flow rate of 3000 cm³/min is used to create the oxygen free inert atmosphere to avoid combustion of biomass. The unit continuously records the loss in the weight of the sample because of thermal decomposition as a function of time and temperature. Working of TGA for mustard stalk was shown in Plate 3.8. From these data, the percentage conversion is calculated at different temperature. The percentage weight loss per degree rise in temperature can be used for defining exact degree of pyrolysis process.

3.2 Designing of Prototype Briquetting Machine

The design of screw press is necessary for continuous production of briquette from low bulk density waste to convert it an efficient burning fuel. There are several types of briquetting technique available in present context. The screw extruder machine gives better quality briquette having more density and clean combustion. Considering all the factors, it is proposed to design and develop a simple, convenient and efficient screw press briquetting machine of approximately 150 kg/h capacity for mustard stalk. Continuous feeding force creates a pressure on the material which causes better compaction. The components of briquetting machine like screw, die, connecting rod, hopper and housing were designed on the basis of the physical properties of biomass studied earlier. The pre-heater was also designed to reduce the power consumption required for preparation of briquettes. The aim to design the preheater was to heat the mustard stalk, so that the lignin present in the mustard stalk may flows. This will act as binding material in the process. The die was heated to further allow the lignin to flow from the material as a binder to compact the briquette. This requires excess amount of power, thus alternative method of preheating of biomass was selected. The technology of screw press with preheater was selected with a view to reduce the power consumption for briquetting (Anon 2003, Bhattacharya *et al.* 2005 and Moral 2005).



Plate 3.7 Thermo Gravimetric Analyser (TGA)



Plate 3.8 TGA Analyser in working for mustard stalk analysis

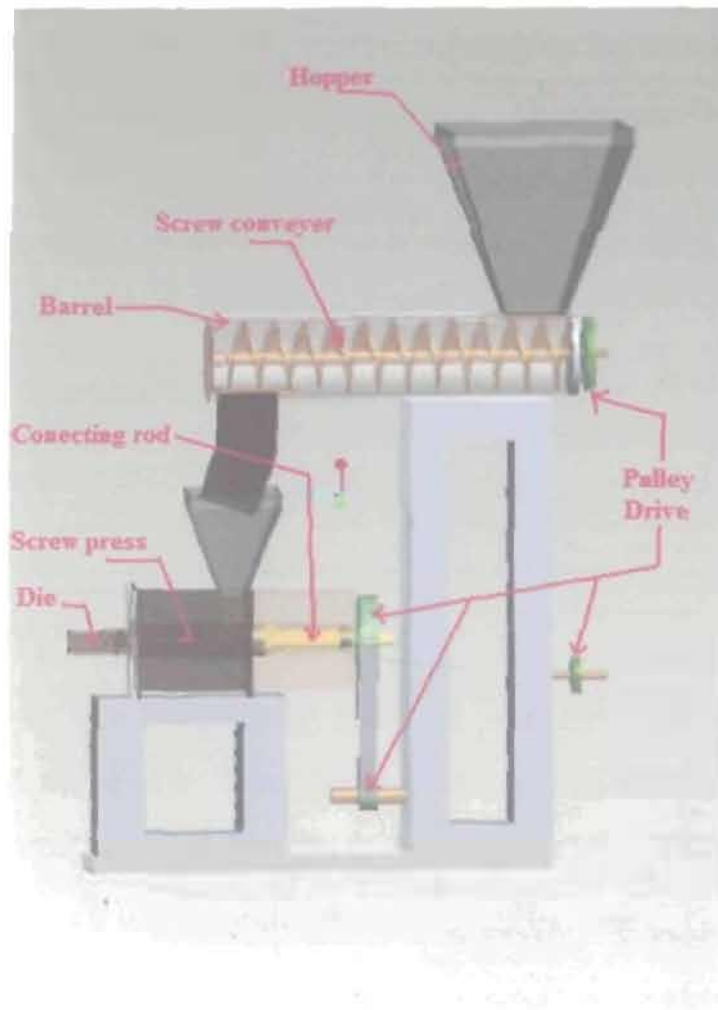

Plate 3.9 Components of screw press briquetting machine

3.2.1 Screw press briquetting machine

Continuous pressing by means of expellers (also known as screw press) is a widely applied process for the compaction of low bulk density waste to convert it in to a solid form. It replaces the historical method of the batch wise compaction of waste by piston or hydraulic pressing. The expeller consists of a screw (or worm), rotating inside a cylindrical cage (barrel). The material to be pressed is fed between the screw and barrel and propelled by the rotating screw in a direction parallel to the axis. The configuration of the screw and its shaft is such that the material is progressively compressed as it moves on, towards the discharge end of the cylinder. The compression effect can be achieved, for example by decreasing the clearance between the screw shaft and the cage (progressive or step-wise increase of the shaft diameter) or by reducing the length of the screw flight in the direction of the axial movement. The gradually increasing pressure releases the temperature which tends to flow lignin which act as a binder in the process, while the press waste continues to move in the direction of the shaft, towards a discharge gate installed at the other extremity of the machine.

3.2.2 Components of briquetting machine

Essentially briquetting machine is having following components (Plate 3.9).

- a) **Briquetting stand:** A base is required which adequately supports the briquetting barrel & screw assembly.
- b) **Drive mechanism:** The briquetting machine is driven with electrical motor with the help of pulley drive. The three groove pulley is mounted on motor as well as on the shaft of connecting rod for power transmission to obtain desire speed.
- c) **Thrust bearings:** The briquetting screw is normally supported with a bearing at the driven end. A significant rearward thrust must be absorbed in the bearing to compensate for the force imparted to the briquetted material as it is being moved forward along the length of the screw.
- d) **Feed hopper:** The feed hopper provides the opening through which feed materials enter the screw.

- e) **Barrel:** The barrel of the extruder is often manufactured in sections which are bolted or clamped together. Because barrel sections are heavy, such construction aids di-assembly and allows for replacement of sections without replacing entire barrel.
- f) The internal diameter of the briquetting machine often denotes the basic size. Barrel length (L) is also very important. The longer the barrel, the greater is the surface for heating or cooling and coupled with longer residence time, leads to greater control. Extruders have varying L/D ratios, ranging from 1 to 3:1 for pallet extruders and 15 to 25:1 for high shear extruders. Internal operating pressures in the extruder barrel normally range from 15 to 75 atmospheres with dry extrusions.
- g) **Die:** The extruder is normally equipped with a series of shaped holes where briquetting material emerges from the machine in the form of briquettes. The die holes can take number of shapes to form the briquettes into rods, spheres, denotes, tubes, strips etc.

3.2.3 Anderson vector shaft analysis technique

The worm shaft was designed by adopting the Anderson Vector Shaft Analysis Technique. The basic objective in the shaft design was to maintain a steadily increasing pressure on a material as it moves from one worm to another along the shaft. Here it is expected that pressure will compact the material and the next worm will have to compensate for this compaction just to maintain the pressure exerted by the previous worm. The idea was to subject the material to a steadily increasing compaction and do this as smoothly as possible from one worm to the next. Following criteria was adopted for design.

- 1) From the dimensions of all the worm parts and the rotational speed of the shaft, the m^3/min displacement of each worm along the shaft was calculated.
- 2) From the production capacity of the material being pressed the kg/min of material entering the shaft and pressed out the material along the length of the shaft was calculated. The kg/min of material flowing across each worm was also calculated.

- 3) Then density of the material as compaction progresses from worm to worm was also predicted, and computations on the m^3/min of material was made. This was compared to the volumetric displacement of each worm and a judgment was made as to whether that worm contribute to compaction or allow a loss of compaction, and to what extent.

3.2.4 Theoretical considerations

The design of briquetting machine involves the relationship between screw and barrel geometry and feed material properties with flow rate, pressure drop and power consumption. To solve the basic flow equations, the following assumptions were made:

- i. Flow should be laminar.
- ii. Flow should be steady.
- iii. Flow should be fully developed.
- iv. Barrel should be stationary and the screw is rotating.
- v. Slip should not occur at the walls.
- vi. Mustard stalk should be incompressible.
- vii. Gravity forces should be negligible and
- viii. Inertial forces should also be negligible.

3.2.5 Design consideration

Basic design parameters considered were as follows:

- Machine Capacity (Q) = 150 Kg/h
- Die diameter (D_d) = 90 mm
- Bulk Density (ρ) in Kg/m^3

Similarly, the assumed Parameters were

- Diameter of Screw in mm
- Pitch of the screw press in mm
- Shaft Diameter in mm

3.2.5.1 Calculation of helix angle

The briquetting machine consisted of extruder screw rotating in a barrel, fitted tightly with connecting rod. The briquetting screw consisted of a central shaft upon

which a helical flight was wrapped. The open area bounded by the flights on the sides was lead. The root of the screw at the bottom and the barrel on the top is known as the channel. The diameter of the screw (D) is the inside diameter of the barrel & the flight height (H) is the distance from the root of the screw to barrel. The helix angle (θ) is the angle that the helical flight makes with the vertical. If pitch S is known than helix angle can be determined from the correlation.

$$\theta = \tan^{-1} \frac{S}{\pi D} \quad \dots \text{(Eq. 9)}$$

3.2.5.2 Determination of theoretical screw volume per pitch

The basic design consideration for the screw design is the capacity of the waste process and the average bulk density of the raw waste after size reduction.

We know that the theoretical screw volume is given by

$$V_s = Area \times Pitch$$

$$V_s = \frac{\pi}{4} (D^2 - d^2) \times S \quad \dots \text{(Eq. 10)}$$

Where, V_s = Theoretical volume of screw, m^3

D = screw diameter, m

d = shaft diameter, m

S = Pitch of the Screw, m

3.2.5.3 Determination of screw revolution

Speed of screw is dependent on mass flow rate, product density, theoretical screw volume per pitch (V_s) and filling.

$$\dot{m} = \frac{Q}{60} \quad \dots \text{(Eq. 11)}$$

$$N = \frac{\dot{m}}{V_s \rho \phi} \quad \dots \text{(Eq. 12)}$$

Where, N = Screw revolution, rpm

ϕ = Mass flow rate, kg/min

φ = Filling efficiency, %

ρ = Bulk density of biomass, kg/m³

3.2.5.4 Determination of drive power

Drive power is dependent on flow rate, gravity, displacement length, resistance.

$$\text{i.e. } P (\dot{m}, V_s, L, \rho, f_i, \eta_d)$$

Neglecting gravitational effects ($g = 1$)

Drive power (P_d) is

$$P_d = \dot{m} \times L \times \frac{f_i}{\eta_d} \times g \quad \dots (\text{Eq. 13})$$

Torque on the screw,

$$\tau = \frac{P_d}{N} \times \frac{30000}{\pi} \quad \dots (\text{Eq. 14})$$

Where, L = Length of the screw press, m

η_d = Efficiency of drive, %

f_i = Material factor

3.2.5.5 Pulley shaft power

Shaft Power (P_s) required for briquetting machine after considering the pulley efficiency

$$P_s = \frac{P}{\eta_p} \quad kW \quad \dots (\text{Eq. 15})$$

Where, η_p = Efficiency of pulley, %

3.2.5.6 Motor power

Motor power P_m was estimated from the given equation.

$$P_m = P_s (1 + \delta) \quad \dots (\text{Eq. 16})$$

The factor δ is the allowances made for motor efficiency taken from Appendix I.

3.2.5.7 Actual motor speed

The actual motor speed (n) is given by selected slip factor “ s ”.

$$n = N (1 - s) \quad \dots (\text{Eq. 17})$$

It is selected from Appendix II on the basis of calculated capacity of electrical motor.

3.2.5.8 Design of pulley

The diameter of smaller pulley was determined by applying Savarin's empirical formula. Pulley design is mainly dependent on the power to be transmitted and required revolution of the machine. The simple drive mechanism was selected for the design.

Small pulley diameter is

$$d_2 = 630 \sqrt[3]{\frac{P_m (KW)}{2 \pi \eta_{max}}} \quad \dots \text{ (Eq. 18)}$$

Where,

P_m = Power to be transmitted, kW

η_{Max} = Maximum speed of shaft, rpm

Now the big pulley diameter is calculated by following formula

$$\frac{N_2}{N_1} = \frac{d_1}{d_2} \quad \dots \text{ (Eq. 19)}$$

Where, N_1 = Revolution of machine shaft, rpm

N_2 = Revolution of motor shaft (known), rpm

d_2 = Diameter of pulley on motor shaft, mm

d_1 = Diameter of pulley on machine shaft, mm

3.2.5.9 Design of connecting shaft

Diameter of connecting shaft of the machine can be calculated using belt velocity, power transmitted and the torque transmitted by the shaft.

Thus firstly the belt velocity (V) is

$$\text{Belt velocity} = \frac{\pi d_1 N_1}{60} \text{ m/s} \quad \dots \text{ (Eq. 20)}$$

Where, d_1 = diameter of pulley, m

N_1 = rpm of machine shaft, rpm

Power Transmitted, (Khurmi R S & Chandra S, 2005)

$$P_m = \frac{(T_1 - T_2) V}{1000} \quad \dots \text{ (Eq. 21)}$$

Where, P_m = Power needed, KW

T_1 = Tension in tight side of belt, N

T_2 = Tension in slack side of belt, N

V = Velocity of belt, m/s

Applying the relation,

$$T = \frac{\pi}{16} f_s d_s^3 \quad (\text{Considering only twisting moment}) \quad \dots \text{ (Eq. 22)}$$

Where, T = torque transmitted by shaft, N mm

$$T = (T_1 - T_2) r \quad \dots \text{ (Eq. 23)}$$

f_s = Shear stress of mild steel, N/mm²

d_s = Shaft diameter, mm

r = radius of pulley, mm

3.2.5.10 Selection of bearing

The bearing selection was made on the basis of the diameter of shaft. Bearing life (L_{10}) is the factor of durability of bearing as per the total usage of the component. Thus the bearing life is as follows

$$L_{10} = \text{years of use (approx.)} \times \text{Days in a yr} \times \text{hours/day} \times \text{min} \times \text{rpm of shaft} \quad \dots \text{ (Eq. 24)}$$

3.2.5.11 Selection of belt

Belt design is possible after consideration of parameters like power to be transmitted by belt (kW) and revolution per minute of faster shaft (rpm). The belt length was selected for required power from the cross section selection chart given in the Appendix III.

3.2.6 Design of preheating system

3.2.6.1 Design considerations of screw conveyer for preheater

The key to any successful screw conveyer design is, firstly through a thorough understanding of the characteristics of the material to be handled. Secondly understanding the action of a screw conveyor is important. It is most important to have thorough knowledge and understanding of the way material flows and effects of variation in the flow. Capacities are usually given in tone per hour (TPH). The conveyor size and speed must be based on maximum volume and the conveyed bulk density of the material.

In preheating process biomass heated to a high temperature. This indicates that it will take less load for a desired compaction level. This will help in reducing the power consumption as well. Thus, a high pressure compacting machine can operate at a lesser load resulting in less wear and tear of the contact parts. As different biomass behaves

differently under varying conditions, it is desirable to predict the conditions for briquetting of each biomass to save the extra load.

3.2.6.2 Estimation of speed of screw conveyer

The screw conveyer was designed after considering the parameters like material to be handled, lump size, capacity required, length of conveyer [Inlet center to outlet center] and the other properties of the raw material like bulk density, material class and H.P. Factor.

$$\text{Therefore, } N_c = (C*4) / (\pi \times [(D_c^2 - d_c^2) \times S_c \times k \times \rho \times 60]) \quad \dots \text{ (Eq. 25)}$$

Where,

C= Capacity of screw conveyer, TPH

D_c= Screw conveyer diameter, m

d_c= Conveyer shaft diameter, m

ρ = Density of material T/m³

k = Power Factor

N_C = Revolution of screw conveyer, rpm

S_c = Screw conveyer pitch, m

3.2.6.3 Estimation of horse power required

Keeping in view 100% loading the capacity can be calculated. Using this calculated capacity one can calculate the required horsepower for the machine. All other rated power parameters were calculated for the drive in the same process as described in the design of screw press.

3.3 Evaluation of Performance of Briquetting Machine and Briquettes

3.3.1 Performance evaluation of briquetting machine

The effect of various factors viz. ingredients, its moisture content on capacity of the briquetting machine and its briquetting efficiency were studied. The factors were identified as per the experimental observation and the prevailing practical condition.

3.3.2 Production of briquettes

The material preparation plays a key role in the successful briquetting of biomass. The raw material available after harvesting on the farm as a waste was cut and chopped

and prepared for briquetting. The cutting and chopping was made by using cutter and hammer mill respectively. The cut material was be preheated and used as a feed material to the hopper. The capacity of feed preparation section of the machine was designed in such a way to match optimally with briquetting capacity of the machine. The screw carries material with it, towards the guide rod. Screw was coupled with motor to rotate at a maximum speed to dense the material. The outer surface of the briquettes obtained through this process was carbonized and had a hole in the centre, which promoted better combustion.

3.3.3 Volumetric energy density of briquette

It is the ratio of calorific value of briquette with the calorific value of raw mustard stalk on volumetric basis.

Thus the calorific value of 1 m³ of mustard stalk ($C V_{\text{stalk}}$) = $\rho_{\text{stalk}} \times C.V$ (k Cal/m³)

Calorific value of 1 m³ of mustard stalk briquette ($C V_{\text{briquette}}$) = $\rho_{\text{briquette}} \times C.V$ (k Cal/m³)

$$E_{\text{volumetric}} = \frac{C V_{\text{briquette}}}{C V_{\text{stalk}}} \quad \dots \text{ (Eq. 26)}$$

Where, ρ_{stalk} = Density of mustard stalk, kg/m³

$\rho_{\text{briquette}}$ = Density of mustard stalk briquettes, kg/m³

C.V = Calorific value of Mustard stalk, kcal/kg

$E_{\text{volumetric}}$ = Volumetric Energy density

3.3.4 Efficiency of heater

Heat required to raise the temperature of mustard stalk can be calculated as follows

$$H = m C_p (T_2 - T_1) \text{ k Cal/kg} \quad \dots \text{ (Eq. 27)}$$

The Heater efficiency is $\eta_{\text{heater}} = H / (P_{\text{heater}} \times 860)$... (Eq. 28)

Where, P_{heater} = Heater power consumption, kWh/kg

C_p = Specific heat of biomass k Ccal/ °C

T_1 = Temperature of biomass before entering to preheater, °C

T_2 = Temperature of biomass after preheating, °C

H_{heater} = Heat required for heating, k Cal/kg

m = Mass of material to be heated, kg/h

3.3.5 Efficiency of briquetting process

Similarly the efficiency of briquetting was calculated to evaluate the machine performance. Heat required to raise the temperature of mustard stalk is as follows

$$H_{briquetting} = m C_p (T_4 - T_3) \text{ k Cal/kg} \quad \dots \text{ (Eq. 29)}$$

The Heater efficiency is

$$\eta_{total} = H_{total} / (P_{total} \times 860) \quad \dots \text{ (Eq. 30)}$$

Where, P_{total} = Heater power consumption, kWh/kg

C_p = specific heat of biomass kcal/ °C

T_3 = temperature of biomass after briquetting, °C

T_4 = Temperature of biomass during briquetting, °C

$H_{briquetting}$ = Heat required for heating, k Cal/kg

m = mass material to be heated, kg/h

3.3.6 Specific energy consumption of screw press briquetting machine

The specific energy consumption can be determined by using following equation,

$$E = \frac{P_m \times 60}{Q} \quad \dots \text{ (Eq. 31)}$$

Where, P_m = Power to be transmitted, kW

Q = Capacity of the machine, Kg/h

E = Specific energy consumption, KJ/kg

3.3.7 Properties of briquettes

The properties of briquette including average width, length, diameter, weight and volume were determined.

Briquette properties like density, durability, radial compressive strength, water resistance stability and shatter index were also studied. The standard procedures were used for determination of properties (Demirbas *et al.* 2004 and Saeidy *et al.* 2004).

3.3.7.1 Briquette density

For briquette density measurement, the briquette length and diameter were measured and thus the volume was calculated. The briquette were weighed using a digital balance. The briquette density was calculated by dividing the average mass of the briquette over its volume.

3.3.7.2 Radial compressive strength

The radial compressive strength of the briquette was measured directly after pressing. The test machine was used for this process. In this, the briquette were placed under the press machine and subsequently the pressure was applied over it. The pressure was applied by using a block having dimensions at least half of the briquette diameter. The pressure at which the briquette gets break was used to determine the radial compressive strength of that briquette using following equation:

$$\text{Radial compressive strength} = \frac{\text{Load at fracture}}{\text{Cross section area of plane of fracture}} \quad \dots \text{ (Eq. 32)}$$

3.3.7.3 Briquette durability

In this study the durability of briquettes were measured according to the standard method of ASAE S269.4, which is intended to assess the durability of cubes, pellets and crumbles. A sample of about 500 g briquettes were placed in a dust tight box. The box was rotated about an axis, which was perpendicular to an axis and centred inside the box. A long baffle was affixed symmetrically and diagonally to a side of the box (Plate 3.10). The sample were rotated for 10 min at 50 rpm. The durability rating was expressed as the ratio of the original mass of the briquette to the briquette remaining after tumbling in accordance with the following equations.

$$a = \frac{m_a}{m_e} \times 100 \quad \dots \text{ (Eq. 33)}$$

$$m_a = m_e - m_p$$

Where, a = Briquette durability, %

m_a = Briquettes remaining, g

m_c = Original weight, g

m_p = Briquette weight after the test, g



Plate 3.10 Durability Measuring Setup

3.3.7.4 Shatter index

Standard test was applied to determine the shatter index of the briquette. The shatter indices (BSI 616) was determined by dropping each briquette 180 cm on to a steel plate and measuring the percentage of the sample that passes through a 75 μ m sieve. This was repeated until all the particles formed by shattering pass through the 75 μ m sieve. Finally the sum of all the percentages were added to find the shatter index (Rieschel, 1977).

3.3.7.5 Water resistance

The water resistivity of the briquettes were arbitrarily tested using standard method by immersing them in a container filled with cold tap water and measuring the time required for the onset of dispersion in water.

3.3.7.6 Stability of briquettes

In order to determine the stability of the briquettes, measurement of length were taken immediately upon removal from the die, after one week of exposure to the atmosphere, and again after five weeks of exposure (Demirbas *et al.*, 2004).

3.4 Evaluation of Techno-Economics of Briquetting Project

3.4.1 Economic evaluation of briquetting project

The economic viability of any system is calculated through economic analysis of the system. The attempt was made to evaluate economic viability of designed proto type briquetting machine. Economic analysis of the system can be carried out by employing following indicators

1. Net Present Worth (NPW)
2. Benefit-Cost Ratio (BCR)
3. Payback Period
4. Internal Rate of Return (IRR)

Following assumptions were made during calculation

- a) Raw material cost: The mustard stalk may be available free of cost.
- b) The operating life of the system is 20 years.
- c) The briquetting machine can operate for 8 hours per day.
- d) Annual working day is 300 days.
- e) Labor cost: Two persons can be involved to produce the briquettes (For biomass feeding- one and for briquette collection - one). Labor charges for two persons Rs. 160/- (@ Rs. 80 each) will be considered.

- f) Electricity cost: Total power consumptions for briquetting unit is 26 kWh @ Rs. 3.5 per kWh.
- g) Selling cost of briquettes per ton @ Rs. 1200/- per ton.
- h) The maintenance cost is 3% of capital cost.
- i) A depreciation cost (Discount rate) is 10 % of capital cost
- j) Capacity utilization at 85 per cent of full load.
- k) Land and building rent at Rs 2000/- per month

3.4.1.1 Net present worth

The net present worth can be computed by subtracting the total discounted present worth of the cost stream from that of the benefit stream.

$$NPW = \sum_{t=1}^{t=n} \frac{B_t - C_t}{(1+i)^t} \quad \dots \text{(Eq. 33)}$$

Where, C_t = Cost in each year

B_t = Benefit in each year

$t = 1, 2, 3, \dots, n$

i = Discount rate

Discount rate is

$$i = (1 + IR/100)^{-1} \quad \dots \text{(Eq. 34)}$$

Where, IR is the interest rate, %

3.4.1.2 Benefit Cost Ratio

Benefit cost ratio is the present value of the benefits to the present value of the cost. Mathematically benefit-cost ratio can be expressed as

$$\text{Benefit Cost ratio} = \frac{\sum_{t=1}^{t=n} B_t}{\sum_{t=1}^{t=n} C_t} \quad \dots \text{(Eq. 35)}$$

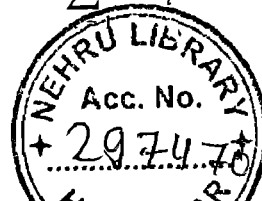

Where, C_t = Cost in each years

B_t = Benefit in each year

$t = 1, 2, 3, \dots, n$

i = Discount rate, %

3.4.1.3 Payback Period

This refers to the time taken by the project to recover the initial investment. It was estimated by adding net cash flow in the project until the cumulative net cash flow equal to initial investment.

3.4.1.4 Internal Rate of Return

Another way of using the incremental net benefit stream or incremental cash flow for measuring the worth of a project is to find the discount rate that makes the net present worth of the incremental net benefit stream or incremental cash flow equal to zero. This discount rate is called the internal rate of return. It is the maximum interest that a project could pay for the resources used if the project is to recover its investment and operating costs and still break even. It is the rate of return on capital outstanding per period while it is invested in the project. The internal rate of return is a very useful measure of project worth.

The internal rate of return can be found out by systematic procedure of trial and error to find that discount rate which will make the net present worth of the incremental net benefit stream equal to zero.

Internal rate of return is the discount rate i such that

$$\sum_{t=1}^{t=n} \frac{B_t - C_t}{(1+i)^t} = 0 \quad \dots \text{(Eq. 36)}$$

RESULTS AND DISCUSSION

In this study, an attempt has been made to utilize the available biomass energy efficiently via route of biomass briquetting in the context of state of Rajasthan. Briquetting of raw agricultural residues is more common practice in India. The commonly used agro residues for briquetting include arhar stalk, cotton stalk, mustard stalk, maize stalk, groundnut shells, rice husk, coir pith, sun flower stalk etc. The factors that mainly influence the selection of raw materials are moisture content, ash content, flow characteristics and particle size. Thus the determination of properties of mustard stalk was prime importance in the present research.

This chapter deals with the research findings and results of the experiment carried out for the study. The information related to availability of agriculture residues, collection of data, related to developed prototype of briquetting machine and briquettes and their properties as bio fuel were also included. The results are presented under following heads:

- ❖ Availability of different biomass & its utilization pattern in Rajasthan.
- ❖ Selection of surplus biomass as raw material for briquetting.
- ❖ Study of properties of mustard stalk used for briquetting.
- ❖ Design and development of a prototype of 150 kg/h capacity briquetting machine.
- ❖ Study of properties of briquettes produced.
- ❖ Techno-economic feasibility of briquetting process.

4.1 Study of the Physio-Chemical Properties of Agro-Residues.

4.1.1 Availability of biomass & its utilisation pattern

Agricultural residues are the most commonly used biomass feedstock for briquetting in India. Availability of agricultural residues as energy feed stocks depend upon the total amount of crop produced and residue to crop ratio for the crop. Table 4.1 presents the availability of different residues, their alternative uses along with the product to residues ratio data in the context of Rajasthan state.

Table 4.1 Availability of agricultural residues, their product to residue ratio and present uses in Rajasthan.

SN	Crop	Crop residue	Product to Residue Ratio	Present use and disadvantages, if any
1.	Rice	Rice husk	1.5	Domestic fuel, Cattle feed, Construction materials, Packing material for glass-wares, raw material for hardboard units
2.	Jowar	Jowar straw	3	Cattle feed
3.	Bajra	Bajra	1.5	Cattle feed
4.	Maize	Maize cobs	4	Domestic fuel, inefficient burning and contributes to indoor air pollution
5.	Wheat	Wheat straw	1.3	Cattle feed
6.	Barley	Barley	1.2	Cattle feed
7.	Millets	Millets	4	Cattle feed
8.	Moong	Moong	1.5	Cattle feed
9.	Urad	Urad	1.5	Cattle feed
10.	Moth	Moth	1.5	Cattle feed
11.	Chaula	Chaula	1.5	Cattle feed
12.	Arhar	Arhar straw	4	Domestic fuel, inefficient burning and contributes to indoor air pollution
13.	Gram	Gram	1.5	Cattle feed
14.	Mater	Mater	1.5	Cattle feed
15.	Batla	Batla	1.5	Cattle feed
16.	Masur	Masur	2	Domestic fuel, inefficient burning and contributes to indoor air pollution
17.	Other Pulses	Other Pulses	1.5	Domestic fuel, Cattle feed
18.	Sesamum	Sesamum	1	Domestic fuel, inefficient

				burning and contributes to indoor air pollution
19.	Ground Nut	Ground Nut shell	1.1	Domestic fuel, Cattle feed
20.	Soyabean	Soyabean	2.1	Domestic fuel, Cattle feed
21.	Castor Seed	Castor Seed	1	Domestic fuel, inefficient burning and contributes to indoor air pollution
22.	Rape seed & Mustard	Rape seed & Mustard stalk	2	Domestic fuel, inefficient burning and contributes to indoor air pollution
23.	Taramira	Taramira	1	Domestic fuel, inefficient burning and contributes to indoor air pollution
24.	Linseed	Linseed	1	Domestic fuel, inefficient burning and contributes to indoor air pollution
25.	Sun flower	Sun flower	2	Domestic fuel, inefficient burning and contributes to indoor air pollution
26.	Mehandi	Mehandi stricks	1.3	Domestic fuel, inefficient burning and contributes to indoor air pollution
27.	Cotton	Cotton stalk	3	Domestic fuel, inefficient burning and contributes to indoor air pollution
28.	Sanhamp	Sanhamp	2	Domestic fuel, Farm manures
29.	Sugar cane	Bagasse	1.6	Energy feed stalk in sugar mills, paper and pulp industry
30.	Guar	Guar	1.5	Cattle feed

Agricultural produce is unavoidable and it has to be biodegraded, if not utilized in some other form. The emphasis in our bio-energy conversion, therefore, should be on the direct use of this residue. The successful experience with the design of screw extruder technology makes it attractive for applications to utilize agro residues. However, this technology yet has to be commercially proven under field conditions. But, clearly, it has

a high potential. keeping our confidence in this technology, it had planned for a major thrust in the future in terms of commercializing the technology on the basis of experimental results.

As many of the above available biomass is used as cattle feed and many other useful purpose. However it is not possible to utilize these waste as an alternative for meeting the domestic energy requirements. Thus the mustard waste which is not usable and having huge potential for energy replacement was selected as a fuel for experimentation i.e. for developing technology for briquetting.

4.1.2 Potential and suitability of available biomass

As potential of mustard residues at Rajasthan was quite high, it was selected as a raw material for study. The botanical name of Indian mustard used is *Brassica juncea* (L.) and it belongs to Czern. & Coss. Brassicaceae Family. As waste mustard stalk is not used for fodder, it can be burnt on the farm or used as a domestic fuel for its disposal. Energy present in the stalk of mustard plant consists of more than 56% of total plant energy. The estimated quantities of crop residues and details of district wise different crops production in Rajasthan state for 2005-06 is given in Table 4.2.

The estimated biomass potential and surplus biomass available in Rajasthan state was 40.78 MT and 20.68 MT for energy purpose respectively. The production of mustard stalk in Rajasthan state was quite huge (7.01 MT). The other essential properties of mustard stalk were studied by standards mentioned by ASTM. The quantity of surplus biomass available in Rajasthan (year 2005- 06) and crop wise contribution of surplus biomass (in percentage) is shown graphically in the Fig. 4.1 and Fig. 4.2 respectively. It is observed that the production of mustard stalk was more (35.09%) followed by cotton stalk 33.35 % and maize 17.63% in total crop production of Rajasthan state.

Table 4.2: Estimated potential of agricultural residues as energy fuel in different districts of Rajasthan state in 2005-06. (Production in tones)

CROPS/ REGION	JAIPUR	BHARA T PUR	GANGA NAGAR	JODH- PUR	KOTA	UDAI- PUR	BHILW ARA	STATE	Bio-Product ratio	Surplus Biomass Available	Surplus Biomass Utilized
Rice	19	11954	70206	1	35921	33451	1474	153026	1.5	229539	172154.25
Jowar	12277	47946	319	34199	47178	2648	25090	169657	3	508971	-
Bajra	591569	747265	169253	616627	33155	142	1242	2159253	1.5	3238879.5	-
Maize	10203	11302	30	41671	181510	411642	445770	1102128	4	4408512	3526809.6
Wheat	1096121	1348199	1252101	419657	938349	368035	442819	5865281	1.3	7624865.3	-
Barley	213874	50485	73130	32303	13582	26437	48193	458004	1.2	549604.8	-
Millets	0	12	1	3784	0	1603	16	5416	4	21664	-
Total Cereals	1924063	2217163	1565040	1148242	1249695	843958	964604	9912765		16327550	3698964
Moong	31747	49	7903	78908	10454	56	833	129950	1.5	194925	-
Urad	891	1613	176	200	14833	12777	4608	35098	1.5	52647	-
Moth	1529	29	46680	101179	10	1	5	149433	1.5	224149.5	-
Chaula	22236	19	76	3674	25	36	115	26181	1.5	39271.5	-
Arhar	199	2842	37	1175	753	8048	139	13193	4	52772	39579
Gram	135519	28543	164516	53824	22256	35114	39161	478933	1.5	718399.5	-
Mater	19465	594	908	3242	7139	66	285	31699	1.5	47548.5	-
Batla	0	0	0	0	19	0	0	19	1.5	28.5	-
Masur	2	7084	13	1	5809	26	3815	16750	2	33500	-
Other Pulses	51	47	0	1868	532	13281	1013	16792	1.5	25188	7116.75
Total Pulses	211639	40820	220309	244071	61830	69405	49974	898048		1380055	46695.75

CROPS/ REGION	JAIPUR	BHARA T PUR	GANGA NAGAR	JODHP UR	KOTA	UDAI PUR	BHILW ARA	STATE	Bio- Product ratio	Surplus Biomass Available	Surplus Biomass Utilized
Sesamum	2286	9587	5679	28230	8348	1205	7472	62807	1	62807	50245.6
G.Nut	191892	13787	110159	93223	17094	5096	59762	491013	1.1	540114.3	432091.44
Soyabean	25	2428	0	8	676503	20040	157303	856307	2.1	1798244.7	1348683.5
Castor Seed	246	13	24513	110488	7	58	40	135365	1	135365	67682.5
R&M	561901	1123340	651303	611222	1105022	27669	305394	4385851	2	8771702	7017361.6
Taramira	5673	886	6057	9724	3707	260	4671	30978	1	30978	23233.5
Linseed	19	1	2	367	844	25	262	1520	1	1520	760
Sun flower	7	0	2	11	1	0	0	21	2	42	31.5
Total Oilseeds	762049	1150042	797715	853273	1811526	54353	534904	5963862		11340773	8940090
Mehandi	3	0	6	33634	0	0	4	33647	1.3	43741.1	34992.88
Cotton	14938	32978	708108	63573	674	32837	27377	880485	3	8337564.2	6670051.4
Sanhamp	33	42	0	38	70	308	77	568	2	1136	908.8
Sugar cane	4234	24316	109430	1949	188510	43930	110265	482634	1.6	772214.4	617771.52
Guar	78788	19714	299890	171372	4899	9522	9033	593218	1.5	889827	711861.6
Total	963117	925896	1552466	1384934	1219944	583557	850853	7480767		11743642	8000593
Grand Total	3860868	4333921	4135530	3630520	4342995	1551273	2400335	24255442		40792020	20686343

Source: The Panchayati Raj and Visak Darpan (2005-06)

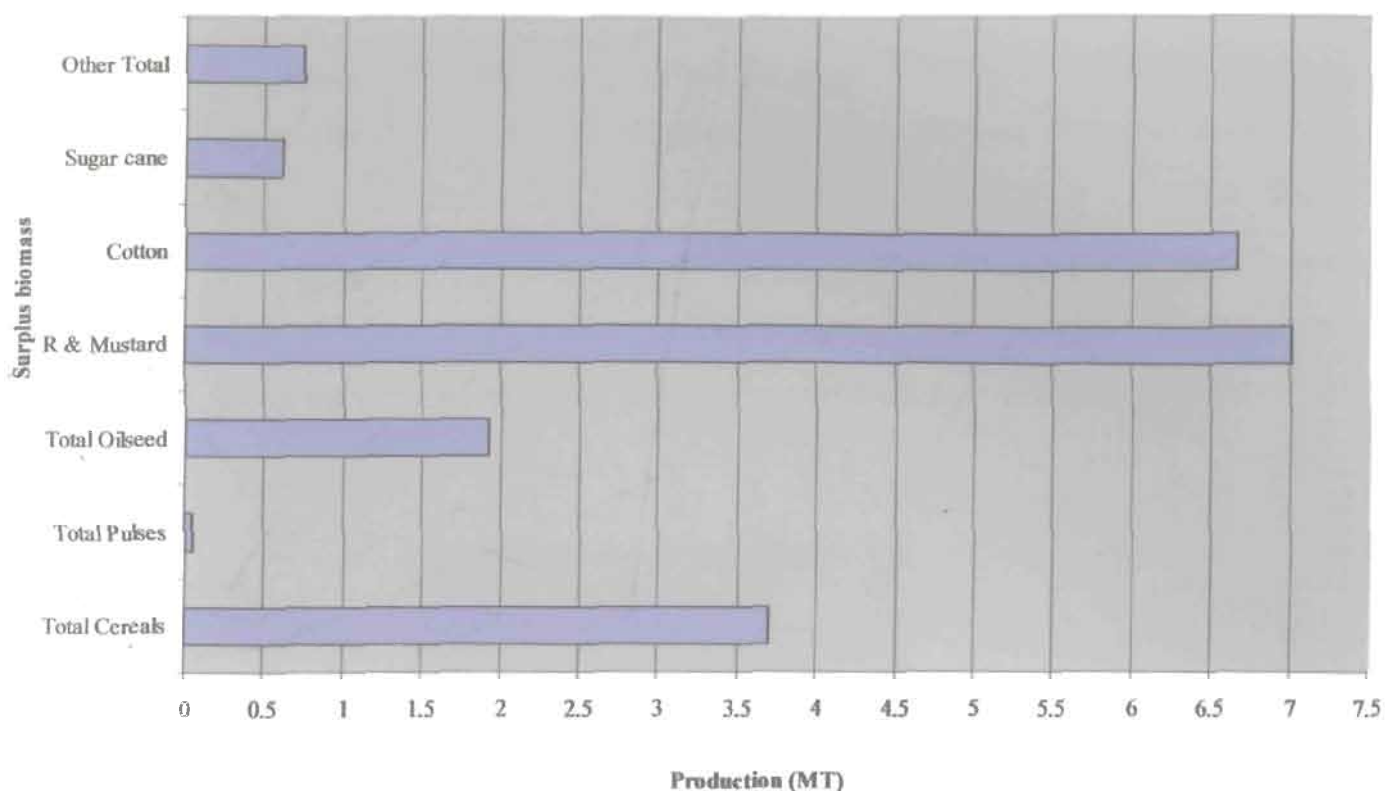

Fig. 4.1 Surplus Biomass Available in Rajasthan State (Year 2005-06)

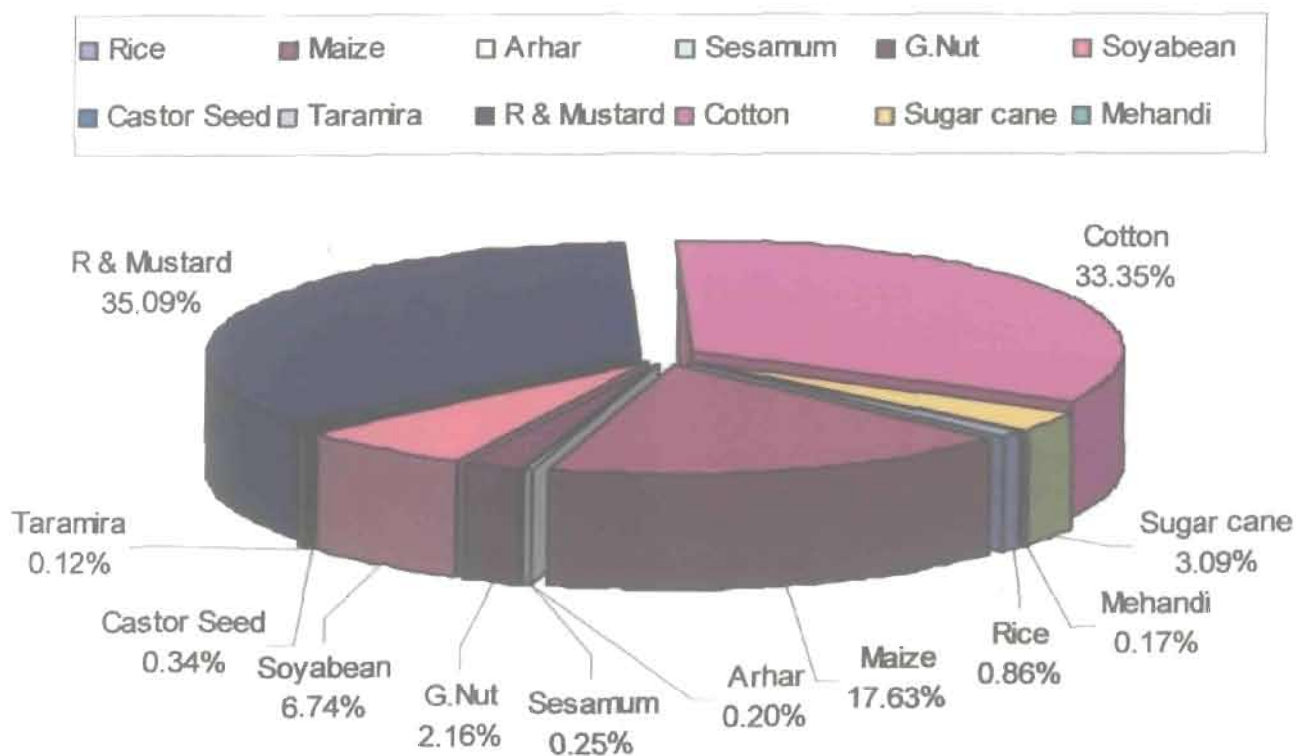

Fig 4.2 Crop Wise Contribution of Surplus Biomass (in Percentage)

4.1.3 Properties study of mustard stalk used for briquetting

Mustard stalks used for experimentation were non-woody biomass with flaky structure and also found to be an easy material for briquetting after being ground to a suitable size. The required properties of mustard stalk were studied before it is utilized for understanding of the nature of waste. Usually biomass is a complex fuel, composed of the volatile components (typically 70-90%), charcoal that results on heating (10-30%), some mineral/ash content (1-20%) and varying amounts of moisture. The pictorial view of mustard stalk being utilized was given in the Plate 4.1 below.



Plate 4.1 Pictorial view of Mustard Stalk used as energy fuel

The properties of biomass like proximate analysis, ultimate analysis, angle of repose, determination of lignin and other were studied as per methodology described in Chapter III and their values obtained are listed in the Table 4.3 below.

Table 4.3 Properties of mustard stalk utilized for briquetting

S. No.	Properties	Unit	Value
1	Moisture Content	%	4.875
2	Bulk Density	kg/m ³	158
3	Calorific Value	kcal/kg	3765.23
		MJ/kg	15.76
4	Angle of Repose	Degree	39.80
5	Static Coefficient of Friction on different surfaces		
I	Mild Steel	-	0.531
II	Stainless Steel	-	0.383
III	Galvanized Iron	-	0.487

IV	Aluminium	-	0.531
V	Plywood Sheet	-	0.466
6	Proximate Analysis		
I	Ash Content	%	13
II	Volatile Matter	%	69
III	Fixed Carbon	%	18
7	Ultimate Analysis		
I	Carbon	%	45.17
II	Hydrogen	%	5.15
III	Oxygen	%	42.92
IV	Sulphur	%	0.14
V	Nitrogen	%	0.75
VI	Ash	%	5.87
8	Chemical Property		
I	Lignin	%	23.5
II	Cellulose	%	52.5

4.1.3.1 TGA Analysis of mustard stalk

Thermo Gravimetric Analysis (TGA) of the mustard stalks gives the detail idea about the weight loss of residue with respective rise in temperature and time. It is observed that there is significant weight loss of residue from 25 mg to 15 mg with temperature gradient of 120 °C and in the time span of 10 min (Fig. 4.3 and Fig. 4.4). The decomposition of mustard stalk takes place at temperature more than 250 °C which started losing volatile matter with releasing the mixture of gases, vapors with some tar or liquid fuel as lignin. Once the temperature reaches 350 °C a self sustaining exothermic reaction takes place in which material structure of biomass breaks downs (Rathore et al 2006). These data is useful for identification of required temperature for lignin flow. Lignin is helpful to provide a barrier for degradation by softening the outer surface of briquette. Data is also useful to verify the preheating temperature for mustard stalk.

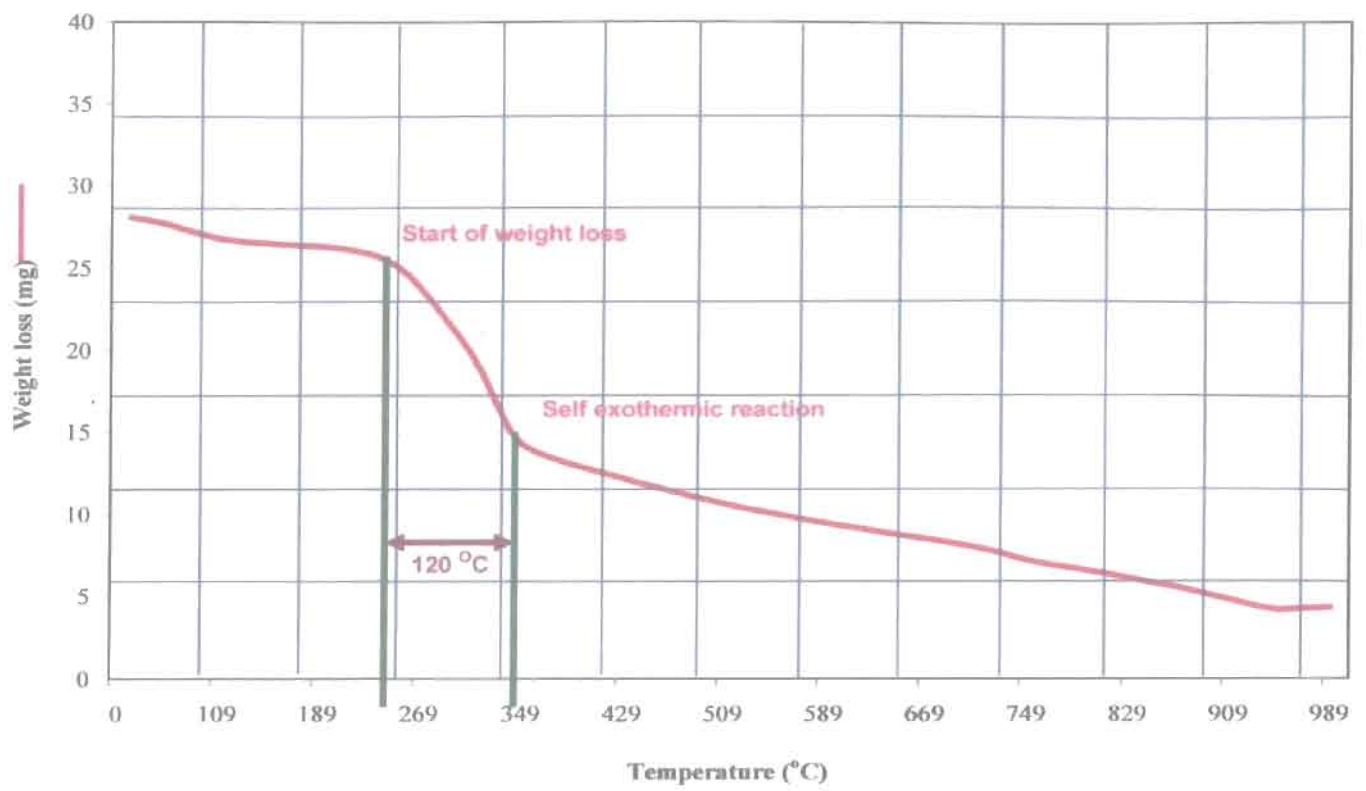

Fig. 4.3 Weight loss of mustard stalk sample with temperature

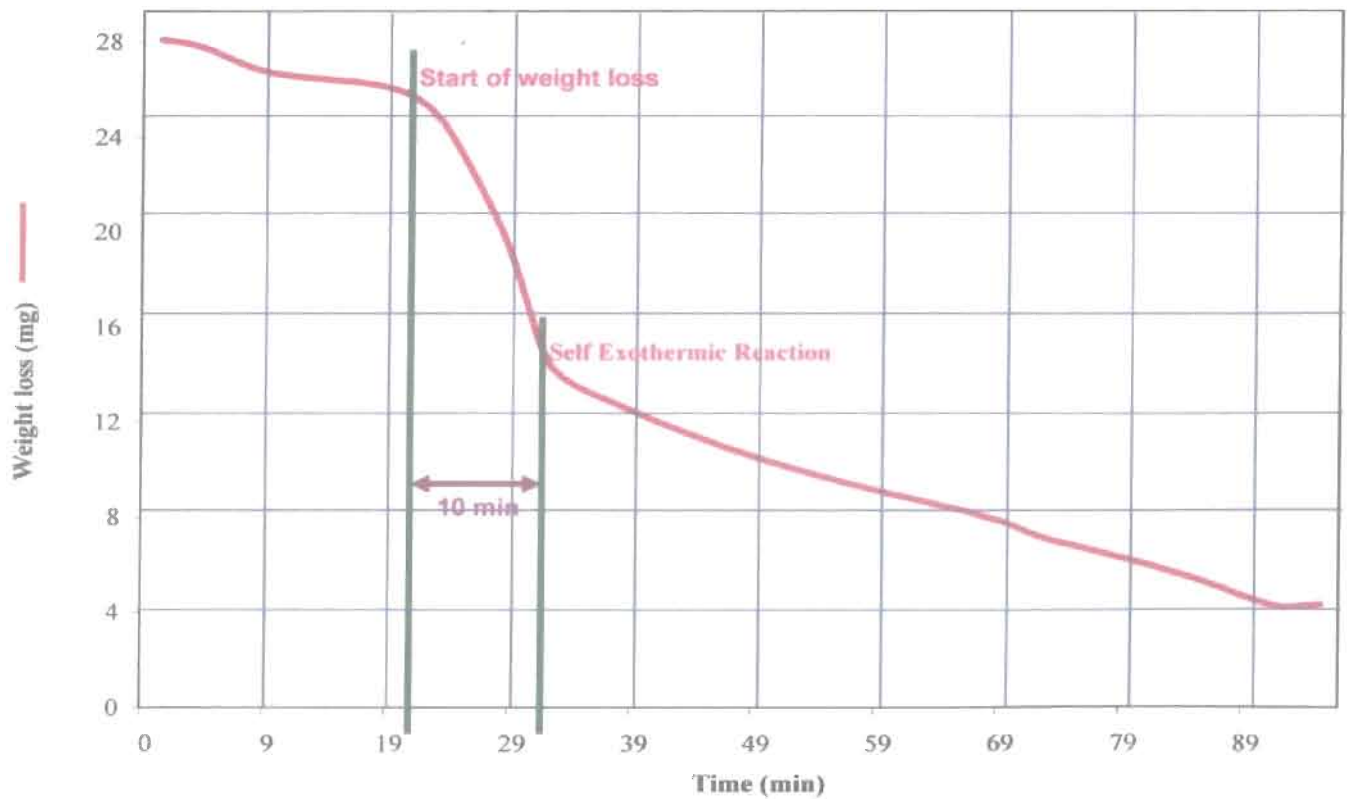

Fig. 4.4 Weight loss of mustard stalk sample with time

4.2 Design of Prototype Briquetting Machine

The properties of mustard stalk and the basic assumption listed below were considered for design of 150 kg/h capacity screw press briquetting machine.

Basic design parameters considered were as follows:

- Machine Capacity (Q) = 150 Kg/h
- Die diameter (D_d) = 90 mm
- Bulk Density (ρ) (for loose biomass after experimentation) = 158 Kg/m³

Similarly, on the basis of required capacity assumed parameters were

- Diameter of Screw (D) = 102 mm
- Shaft Diameter (d) = 30 mm
- Pitch of the screw press (S) = 0.35D = 35 mm

4.2.1 Die of the briquetting machine

The cylindrical shape briquette of diameter 80 mm with a concentric hole of 25 mm and length 110-150 mm was found suitable for different thermal application. The tapered die of round shape was fabricated in the workshop by cutting a solid mild steel rod on lathe machine.

Die diameter = 90 mm

Die length = 210 mm

Die material = Mild steel

Die thickness = 11 mm

The taper die having outlet diameter of 90 mm while the other end diameter was of 120 mm. The die length was design as per screw length so that the briquette should be formed. Thus the die length was of 210 mm with a thickness of 11 mm which was having sufficient strength and capability to withstand to the heat generated and provided for the process.

4.2.2 Calculation of helix angle

The helix angle for the screw design mainly depends on the diameter of the screw and the pitch of screw press. It was calculated from the given formula below

$$\theta = \tan^{-1} \frac{S}{\pi D}$$

After substituting the values considered above the helix angle is

$$\theta = \tan^{-1} (0.035 / 3.14 \times 0.102)$$

$$\theta = \tan^{-1} (0.109) = 6.24 \text{ degree}$$

4.2.3 Determination of theoretical screw volume per pitch

The volume of biomass carried out through one pitch was calculated to know the material holding capacity of the screw

It was as follows: $V_s = Area \times Pitch$

$$V_s = \frac{\pi}{4} (D^2 - d^2) \times S$$

$$V_s = 3.14/4 \times (0.102^2 - 0.03^2) \times 0.035$$

$$V_s = 2.611 \times 10^{-4} \text{ m}^3$$

4.2.4 Determination of screw revolution

Speed of screw is dependent on mass flow rate, product density, theoretical screw volume per pitch, and filling.

$$\dot{m} = \frac{Q}{60}$$

Mass flow rate of mustard stalk waste provided to 150 kg/h capacity machine was

$$\dot{m} = 150 / 60$$

Mass flow rate, $\dot{m} = 2.5 \text{ kg/min}$

$$N_1 = \frac{\dot{m}}{V_s \rho \phi}$$

Where, ρ is the density of mustard stalk = 158 kg/m^3 and ϕ is the filling efficiency = 30 % . From above formula the revolution required was estimated

$$N_1 = 2.5 / (2.611 \times 10^{-4} \times 158 \times 0.3)$$

$$N_1 = 201.98$$

$$N_1 \approx 202 \text{ rpm}$$

4.2.5 Determination of drive power

The power required to transfer the material from first flight to the die was estimated by the formula given below.

$$P_d = \dot{m} \times L \times \frac{f_1}{\eta_d} \times g$$

Neglecting gravitational effects (g) and considering the drive efficiency as 55 %, Drive power calculated is

$$= 2.5 \times 0.55 \times 3/0.55$$

$$P_d = 7.5 \text{ kW}$$

After consider the correction factor = 7.5×1.01

$$P = 7.57 \text{ kW}$$

Torque on the screw,

$$\tau = \frac{P}{N_1} \times \frac{30000}{\pi}$$

$$= (7.57/202) \times (30000/3.14)$$

$$\tau = 358.28 \text{ Nm}$$

4.2.6 Pulley shaft power

Power required for briquetting machine after considering the pulley efficiency as 55% for pulley and belt drive.

$$P_s = \frac{P}{\eta_p} \text{ kW}$$

$$= 7.57 / 0.55$$

$$P_s = 13.76 \text{ kW}$$

Where, η_p was the pulley efficiency in %

4.2.7 Motor power

The factor δ is the allowances made for motor efficiency. Motor allowance factor for 13.76 kW motor is selected from the chart in Appendix I ($\delta = 0.10$)

$$P_m = P_s (1 + \delta)$$

$$= 13.76 \times (1 + 0.10)$$

$$P_m = 15.82 \text{ kW}$$

Thus the available motor power of 20 hp was adopted for the design operation.

4.2.8 Actual motor speed

The actual motor speed is given by selected slip factor “s”. From Appendix II slip factor for 15.82 kW motor is 5.5 % .

Actual motor speed estimated is $N_2 = N_1 (1 - s)$

$$N_2 = 960 \times (1 - 0.055)$$

$$N_2 = 907.2 \text{ rpm}$$

4.2.9 Design of drive pulley diameter

Saverin's empirical formula was used to determine the diameter of smaller pulley. Pulley design is mainly depends on the power to be transmitted and required revolution of the machine. The simple drive mechanism was selected for the design.

Small pulley diameter was estimated

$$d_2 = 630 \sqrt[3]{\frac{P_m (kW)}{2 \pi N_2}}$$

$$d_2 = 630 \sqrt[3]{\frac{15.82}{2 \times \pi \times 907.2}}$$

$$d_2 = 630 \times 0.14$$

$$d_2 = 88.54 \text{ mm}$$

Thus, small pulley of standard diameter was selected as $d_2 = 100 \text{ mm}$

4.2.10 Driven pulley diameter

Now, the big pulley diameter was estimated by substituting the calculated values of rated motor speed, actual motor speed and diameter of big pulley in following formula

$$\frac{N_2}{N_1} = \frac{d_1}{d_2}$$

$$907.2 / 202 = d_1 / 88.54$$

$$d_1 = 397.6 \text{ mm} = 0.397 \text{ m}$$

4.2.11 Design of shaft

Thus firstly the belt velocity (V) was calculated as

$$\text{Belt velocity} = \frac{\pi d_1 N_1}{60} \text{ m/s}$$

$$V = (3.14 \times 0.397 \times 202) / 60$$

$$V = 4.186 \text{ m/s}$$

Power Transmitted,

$$P = \frac{(T_1 - T_2) V}{1000}$$

$$15.82 = ((T_1 - T_2) \times 4.186) / 1000$$

$$(T_1 - T_2) = 3779.26 \text{ N mm}$$

Where as, $T = (T_1 - T_2) r$

r is the radius of big pulley i.e. $= 397/2 = 199 \text{ mm}$

$$T = 3779.26 \times 199$$

$$T = \frac{\pi}{16} f_s d_s^3 \text{ (Considering only twisting moment)}$$

$$3779.26 \times 199 = (3.14 / 16) \times 42 \times d_s^3$$

$$d_s^3 = 91243.28$$

$$d_s = 45 \text{ mm} = 50 \text{ mm shaft}$$

Where, T = Torque transmitted by shaft, N mm

f_s = Shear stress of mild steel = 42 N/mm²

d_s = Shaft diameter, mm

4.2.12 Selection of bearing

$$L_{10} = \text{years of use (approx.)} \times \text{Days in a yr} \times \text{hours/day} \times \text{min} \times \text{rpm of shaft}$$

$$= 6 \times 300 \times 8 \times 60 \times 202$$

$$L_{10} = \text{Bearing life} = 174.52 \times 10^6 \text{ revolution}$$

Considering diameter of shaft, bearing of basic design No. 6312 was selected.

4.2.13 Selection of belt

The belt length for the given power motor was selected from the cross section selection chart given in the appendix III.

So, Power to be transmitted by belt = 15.82 kW i.e. 20 hp motor

Rev/min of faster shaft = 960 rpm

From cross section selection chart, B section belt was selected for 960 revolution/min.

Length of belt = 1290 mm.

Standard belt according to length of belt = B 90

4.2.14 Developed briquetting machine

Overall specifications of the developed screw press are given in Table 4.4.

Table 4.4 Specifications of the screw press briquetting machine

No. of screws	:	1
Diameter of shaft	:	32 mm
Length of die	:	210 mm
Diameter of die	:	90 mm
Overall length of machine	:	100 cm
Overall width of machine	:	90 cm
Overall height of machine	:	60 cm
Capacity of machine	:	150 kg/hr



Plate 4.2 Developed Screw Press Briquetting Machine with Heated Die



Plate 4.3 Developed screw press Briquetting machine with Preheater system



Plate 4.4 Die with Mica band heating system

4.2.15 Design of preheating system

4.2.15.1 Design considerations for screw conveyor of preheater

The details of behaviour of biomass under different temperature for density were studied and considered for the preheater design. As per the work done by researchers for different biomass including mustard, it was observed that (Fig 4.5) the maximum density for mustard stalk was possible at 120 °C temperature and at the pressure of 250 kg/cm² (P. D. Grover & S. K. Mishra, 1995).

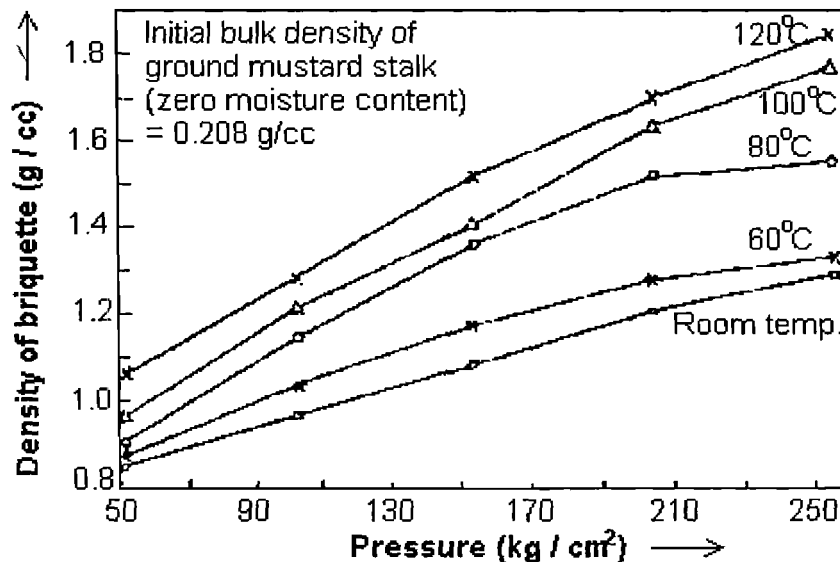

Fig. 4.5 Variation of density with pressure at different temperatures for mustard stalk

This can also be observed from the Fig. 4.6 that the bulk density of the mustard stalk increased by 8.9 times when subjected to a temperature of 120 °C. This describes the fact that with an increase in temperature the resistance of the material decreases against an applied load by giving a better compaction. But the decrease in resistance of material is not the same for all kinds of materials.

This indicates that a biomass heated to a high temperature will take less load for a desired compaction level. This will help in reducing the power consumption as well. Thus, a high pressure compacting machine can operate at a lesser load resulting in less wear and tear of the contact parts. As different biomass behaves differently under varying conditions, it is desirable to predict the conditions for briquetting of each biomass to save the extra load.

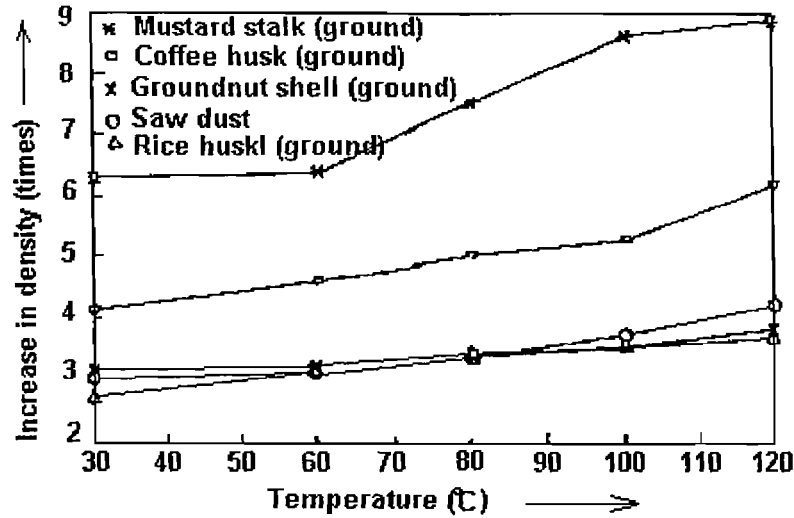

Fig. 4.6 Variation in density with temperature for different materials

By observing the change in bulk density with the temperature of the raw material from Fig. 4.5 it was suggested that coffee husk and mustard stalks be heated to more than 100 °C, whereas sawdust, groundnut shells and rice husk can be heated to below 100 °C to get maximum benefit from preheating.

From the TGA analysis it was observed that there is a significant change in weight loss at a temperature range of 100-120 °C which is contributed to the lignin flow. This condition is suitable for the densification of biomass. While after this condition the biomass is favourable to the process of pyrolysis. Therefore, the preheating temperature of mustard was selected at 120 °C for the experimentation.

4.2.15.2 Heating system for preheater

The mica band electrical heater of capacity 2 kW with a diameter of 260 mm was developed for preheater system to heat the biomass and conveyed to the screw press with the help of screw conveyer. The overall length of the conveyer was 1200 mm with a barrel diameter of 260 mm. The four numbers of heaters were used to get the heating through overall length of the conveyer. Thermal conduction phenomenon was adopted for heat transfer. It was the process of heat transfer from one part of a body at a higher temperature to another (or between bodies in direct contact) at a lower temperature. This happens with negligible movement of the molecules in the body, because the heat is transferred from one molecule to another in contact with it. Heat can be conducted through solids, liquids and gases. Some materials conduct more rapidly than others. The electrical heater was used to heat the preheater conveyer to obtain 120 °C biomass temperature at the outlet of the preheater. The temperature

monitoring device was also provided to set and monitor the temperature to get the desired output (biomass at 120 °C). For a given temperature difference, the higher the thermal conductivity of a material of fixed thickness and cross-sectional area, the greater is the quantity of heat transferred. The various specifications of developed preheated assembly is given in Table 4.5

Table 4.5 Specifications of Preheater

Particulars	Unit	Value
Heater body material		Mica band
Heater diameter (For Preheater)	mm	260
(Die heating)	mm	100
Temperature controller	°C	0- 400
Heater thermostat (Die)	°C	0- 400
Capacity (Preheater)	kW	2 (4 Nos)
(Die)	kW	1 (1 No)

4.2.15.3 Feeding hopper

The trapezoid feeding hopper of 600x600 mm top and 200x200 mm bottom with a height of 540 mm was provided to feed the chopped biomass for preheating. There was a gate at the bottom of the hopper to maintain the flow rate of biomass if it required. The mild steel sheet of 2 mm thickness was used for fabrication of the hopper. The capacity of the hopper is design such that it should not be heavy and a labour able to feed it conveniently.

4.2.15.4 Estimation of conveyer speed

The screw conveyer was design after considering the parameters like material to be handled, lump size, capacity required, length of conveyer (inlet center to outlet center) and the other properties of the raw material like bulk density, material class, H.P factor. The filling efficiency of screw conveyer was also considered in the design to get the required flow rate.

$$C = 3.142/4 \times [(D_C^2 - d_C^2) \times S_C \times k \times \rho \times N_{C1} \times 60$$

Considering, screw diameter= 0.250 m; shaft diameter= 0.050 m; pitch of screw conveyer = 0.1 m; K factor = 0.2; density of mustard stalk = 0.158 tons/m³ and required capacity of screw conveyer = 0.15 tons/h

$$0.150 = 3.142/4 \times [(0.25^2 - 0.05^2) \times 0.1 \times 0.2 \times 0.158 \times N_{C1} \times 60$$

$$\text{Required Speed of Conveyer } N_{C1} = 0.15 / 0.0089 = 16.80 \text{ rpm}$$



Plate 4.5 Temperature control panel for Mica band heaters of preheater



Plate 4.6 Briquetting machine control panel with variable drive for Preheater

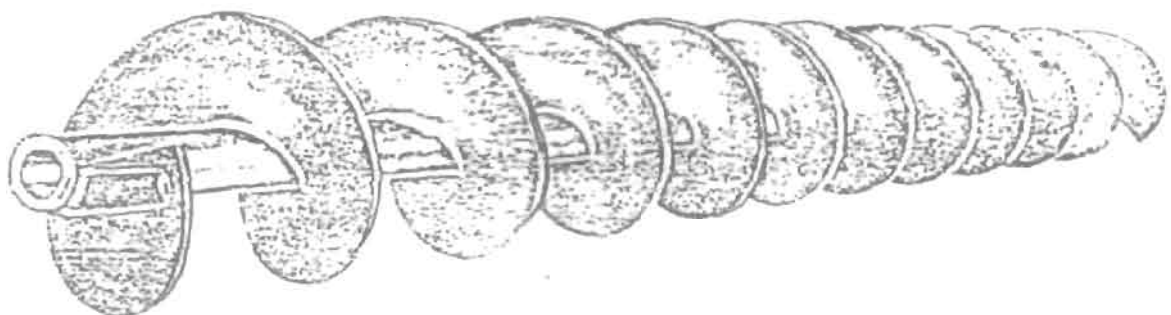

Fig. 4.7 Right hand Screw Conveyor used in preheating chamber

4.2.15.5 Design of conveyer flight

Sectional flights with right hand flights on a single screw were selected in the design. The right handed screw conveyer with flight is shown in Figure 4.7.

The disc internal diameter was calculated from shaft diameter which was (50 mm) essentially an internal diameter of flat disc from which a section flight is to be formed.

Therefore, Circumference of internal diameter of disc diameter on flat steel plate

$$= 3.14 \times \text{Pipe O D}$$

$$= 157 \text{ mm}$$

Disc internal diameter of 50 mm and outer diameter of 250 mm was cut radically and then bent in the form of flight over the pipe. This flight section was butt welded to form the complete screw. Now over all conveyer length = 1m + 2 * pitch of conveyer flight

$$= 1000 + 2 * 100$$

$$= 1200 \text{ mm}$$

$$\text{No. of flights} = 1200/100$$

$$= 12 \text{ flights}$$

It is proposed to take all right handed flights from inlet end of trough to outlet.

Thickness of flight = 4 mm.

Material = Mild steel (MS).

4.2.15.6 Determination of mass flow rate

Mass flow rate of mustard stalk provided to machine through screw conveyer with calculated speed $N_{C1} = 17$ rpm; Volume of screw flight $V_c = \pi/4 (D^2 - d^2) S$; S is pitch of conveyer; Density of mustard stalk (ρ) = 0.158 tons/m³ & filling efficiency (ϕ) = 30 %

$$\dot{m}_c = V_c N_{c1} \rho \phi$$

$$= 0.785 \times (0.25^2 - 0.05^2) \times 0.1 \times 17 \times 0.158 \times 0.3$$

$$= 3.795 \text{ kg/min}$$

4.2.15.7 Determination of drive power

The power required to transfer the material from first flight to the die was estimated as follows.

$$P_c = \dot{m}_c \times L_c \times \frac{f_i}{\eta_c}$$

$$P_c = 3.795 \times 0.82 \times 0.1/0.55$$

$$P_c = 0.56 \text{ kW}$$

Where, f_i = deflection factor = 0.1

L = Center to center distance of screw conveyer, m

$$\text{Torque on the screw, } \tau_c = \frac{P_c}{N_{C1}} \times \frac{30000}{\pi}$$

$$\tau_c = (0.56/17) \times (30000/3.14)$$

$$\tau_c = 925.05 \text{ Nm}$$

The pulley drive mechanism was selected for the machine. The pulley drives having some of less efficiency but economically viable. The motor power utilization was affected by the many factors like slip factor of belt, pulley efficiency etc.

4.2.15.8 Pulley Shaft power

Power required for screw conveyer after considering the pulley efficiency

$$P_s = \frac{P_c}{\eta} \text{ kW}$$

$$P_s = 0.56/0.55$$

$$P_s = 1.02 \text{ kW}$$

4.2.15.9 Motor Power

The factor δ is the allowances made for motor efficiency. Motor allowance factor for 1.02 kW motor was selected from the Appendix I ($\delta = 0.4$)

$$P_p = P_s (1 + \delta)$$

$$P_p = 1.02 \times (1 + 0.4)$$

$$P_p = 1.425 \text{ kW}$$

$$P_p = 1.91 \text{ hp}$$

Thus for preheater screw conveyer the motor power of 2 hp was adopted for the design operation.

4.2.15.10 Actual motor speed

The actual motor speed is given by selected slip factor "s". It was taken from Appendix II on the basis of calculated capacity of electrical motor.

$$N_{C2} = N_c(1 - s)$$

$$N_{C2} = 1500 \times (1 - 0.07)$$

$$N_{C2} = 1395 \text{ rpm}$$

4.2.15.11 Design of Pulley

Saverin's empirical formula was applied to determine the diameter of smaller pulley. Pulley design is mainly depends on the power to be transmitted and required revolution of the machine. The simple drive mechanism was selected for the design.

$$d_4 = 630 \sqrt[3]{\frac{P_s(kW)}{2 \pi N_{C2}}}$$
$$d_4 = 630 \sqrt[3]{\frac{1.02}{2 \times \pi \times 1395}}$$

$$d_4 = 630 \times 0.0488$$

$$d_4 = 30.76 \text{ mm}$$

The big pulley diameter is estimated by following formula

$$\frac{N_{C1}}{N_C} = \frac{d_3}{d_4}$$

$$1395 / 60 = d_3 / 30.76$$

$$d_3 = 715.2 \text{ mm}$$

4.2.15.12 Design of Shaft

$$\text{Belt velocity} = \frac{\pi d_3 N_3}{60} \text{ m/s}$$

$$= (3.14 \times 0.715 \times 60) / 60$$

$$V_C = 2.25 \text{ m/s}$$

Power Transmitted,

$$P = \frac{(T_1 - T_2) V_C}{1000}$$

$$1.02 = ((T_1 - T_2) \times 2.25) / 1000$$

$$(T_1 - T_2) = 454.32 \text{ N mm}$$

Where as, $T = (T_1 - T_2) r$

$$= 454.32 \times 125$$

$$T = \frac{\pi}{16} f_s d_c^3 \text{ (Considering only twisting moment)}$$

$$454.32 \times 125 = (3.14/16) \times 42 \times d_c^3$$

$$d_c = 6889.94$$

$$d_c = 19.02 \text{ mm shaft}$$

Where, T = torque transmitted by conveyer shaft, N mm

$$f_s = \text{Shear stress of mild steel} = 42 \text{ N/mm}^2$$

4.2.15.13 Selection of bearing

L_{10} = Bearing life

$$\begin{aligned}L_{10} &= \text{years of use (approx.)} \times \text{Days in a yr} \times \text{hours/day} \times \text{min} \times \text{rpm of shaft} \\ &= 6 \times 300 \times 8 \times 60 \times 60 \\ &= 51.84 \times 10^6 \text{ revolution}\end{aligned}$$

Considering the diameter of shaft, bearing of basic design No. 6204 was selected.

4.2.15.14 Selection of belt

The belt length for the given power motor was selected from the cross section selection chart given in the appendix.

So, Power to be transmitted by belt = 1.42 kW i.e. 2 hp motor

Rev/min of faster shaft = 1500 rpm

From the cross section selection chart, according to given data, B section belt was selected.

Length of belt = 1000 mm.

Standard belt according to length of belt = B 51



Plate 4.7 Preheater System with mica band heater, sensors and control panel

4.3 Evaluation of performance of briquetting machine and briquettes

4.3.1 Production of briquettes

Mustard stalk briquette was prepared through the developed screw press of diameter 90 mm diameter with varying length as there was no cutter provision. The briquette length was subjected to the bending of briquette according to the length of die. It was observed that the length of briquette was of in the range of 110-210 mm with an inner concentric hole of 25 mm diameter. Die section of the machine has an outer heating element which was increasing the die temperature and consequently the raw material temperature and therefore the better densification. The non contact type thermometer was used for measurement of material temperature.

The preheated mustard stalk of temperature of 100-120 °C was provided to the screw and conveyed to the die section through screw press for briquette formation. The external heating temperature of die was 300 °C. The out coming briquette temperature was noted 40-60 °C. The briquette temperature above 40 °C was accepted on account of its deformation at this temperature. Heating of mustard stalk during the press process has an advantageous result due to the lignin migration from the cell wall to the external surface of the briquette, serving as glue between mustard stalk particles. The briquettes often get partially pyrolysed at the surface, which causes quite a lot of smoking during briquetting. It also acted as a barrier to degradation of briquette. The design of the screw results in the formation of a central circular hole in the briquette; this acts as an escaping steam formed during briquetting. Table 4.6 gives an idea of overall dimension of produced briquettes.

Table 4.6 Main characteristics of mustard stalk briquette

Characteristics	Value	Unit
Diameter	80	mm
Length (Max)	210	mm
(Min)	110	mm
Concentretic hole diameter	25	mm

4.3.2 Properties of briquettes

The properties of briquette like briquette density, radial compressive strength, durability, calorific value, shatter Index, water resistance and stability of briquette

were evaluated as per the standard method and the experimental findings are given in the Table 4.7.

Table 4.7 Characterisation of the mustard stalk briquette

Characterisation	Unit	Value
Briquette density (ρ)	Kg/m ³	1134
Radial compressive strength	kgf/mm ²	15.75
Briquette durability	%	70.22
Shatter index	-	4200
Water resistance	min	50
Stability of briquettes (after die)	m	0.11
(after one week)	m	0.11
(after five weeks)	m	0.11

Typically the density of briquettes produced by using screw type briquetting machine should be in the range of 1100 -1400 kg/cm³ (Demirbas *et al.* 2004 and Saeidy *et al.* 2004). However it is observed that the density obtained in the study was also matching to the desire range.

4.3.2.1 Radial compressive strength

The radial compressive strength of the briquette is mainly depends on the density of briquette. The compressive strength was increasing with increase in briquette density. The Table 4.8 explaining the radial compressive strength of the briquette. The highest value of the strength was 15.75 kgf /mm².

The area of facture = 4533.37 mm²

Table 4.8 Radial compressive strength of Mustard stalk briquette

Applied Load, kg	Load kgf	kgf/mm ²
4600	45126	9.95
6120	60037.2	13.24
7280	71416.8	15.75

4.3.2.2 Water resistance

The water resistance of the briquettes from mustard stalk was moderate. However this property also depends on the briquetting density. It was observed that the briquette started to disintegrate in water in 50 minutes.

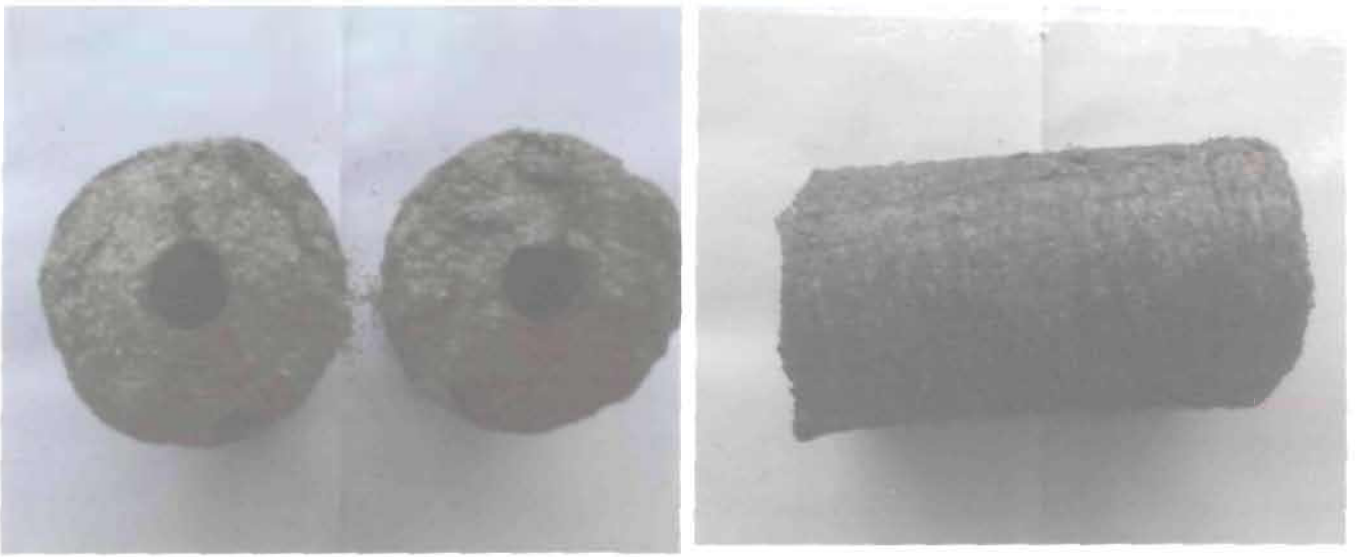

Plate 4.8 Pictorial view of Mustard stalk briquette



Plate 4.9 (a) Performance of Screw press briquetting machine



Plate 4.9 (b) Performance of Screw press briquetting machine

4.3.3 Performance evaluation of briquetting machine

4.3.3.1 Production of Briquette

Experimental results of briquettes produced from developed briquetting machine was presented in the Table 4.8. The briquette produced was examined for the change in density and diameter as per proposed diameter. The Plate 4.8 gives the pictorial view of produced mustard stalk briquette. It is observed that the briquette coming out of die were having the diameter as 80mm while there is variation in length of the briquettes as there was no cutter arrangement. The density of the briquette produced was in the range of 950 to 1136 kg/m³. The moisture content of briquettes was found in the range of 2.9-3.4 %. The briquette temperature after die was in the range of 40- 44.2 °C. It was also observed that the better density was obtained at the low moisture and high die temperature of 2.9 % and 44.2 °C respectively.

Table 4.9 Performance characteristics of produced briquettes

Moisture content	Briquette mass	Briquette length	Briquette density	Briquette temperature
%	kg	m	kg/m ³	°C
3.1	0.28	0.065	950.2175	41.8
3.2	0.35	0.08	965.0647	40.0
2.9	0.90	0.175	1134.443	43.0
3	0.85	0.165	1136.353	44.2
3.4	0.28	0.065	950.2175	42.0

4.3.3.2 Performance of briquetting machine

The experimental results of performance of briquetting machine were reported in the Table 4.9. It was observed that production capacity of the design machine was in the range of 107-140 kg/hour and good quality briquettes could be produced at a die temperature of around 300-380°C. Nevertheless, electrical energy was saved at the heater, motor and overall system due to preheating of biomass. When the die temperature was below 300°C, the quality of briquettes produced was poor, as indicated by many cracks on the briquette surface. Performance of screw press briquetting machine was shown in Plate 4.9 (a and b).

Table 4.10 Power consumption for briquetting of mustard stalk with pre-heating

Average die temp.	Average preheater temp.	Avg. biomass temp. in preheater	Briquette production	Production rate	Power Consumption kWh/kg		
					Heater	Motor	Total
°C	°C	°C	kg/min	kg/hr			
300	270	110	1.795	107.7	0.083	0.160	0.243
310	290	120	2.016	121.0	0.074	0.143	0.216
380	300	115	2.475	148.5	0.060	0.116	0.176
330	320	125	2.343	140.6	0.064	0.122	0.186
350	350	140	2.398	143.9	0.062	0.119	0.181
Average		122	2.205	132.34	0.0686	0.132	0.200

4.3.3.3 Efficiency of heater

Specific heat of biomass was assumed as 0.37 k Cal/ kg °C (P. D. Grover & S. K. Mishra, 1995). The total power consumption in preheating is 8 kW thus for 150 kg/h biomass the heater efficiency for heat transfer from heater to biomass is

$$Q = m C_p (T_2 - T_1) \text{ k Cal/kg}$$

$$P_{\text{preheater}} = \text{Heater power consumption, kWh/kg}$$

$$\eta_{\text{Preheater}} = Q / (P_{\text{preheater}} \times 860)$$

$$\eta_{\text{Preheater}} = 150 \times 0.37 \times (122 - 30) / (8 \times 860)$$

$$\eta_{\text{Preheater}} = 5106 / 6880 \times 100$$

$$\eta_{\text{Preheater}} = 74.2 \%$$

4.3.3.4 Efficiency of briquetting process

Considering the total power consumed in the briquetting process was 26 kW which includes motor power for screw press (16 kW), preheater conveyer (2 kW), preheater heaters (6 kW) and die heating (2 kW). Assuming required temperature for briquette production is 300 °C (P. D. Grover & S. K. Mishra, 1995) thus the heat consumed during the briquetting is as follows

Thus the efficiency is the factor of heat utilized with the heat provided

$$\eta_{\text{total}} = Q / (P_{\text{total}} \times 860)$$

$$\eta_{\text{total}} = 150 \times 0.37 \times (300 - 40) / (26 \times 860)$$

$$\eta_{\text{total}} = 17205 / 22360 \times 100$$

$$\eta_{\text{total}} = 64.53 \%$$

4.3.3.5 Volumetric energy density of briquette

$$\text{Density of mustard stalk } (\rho_{\text{stalk}}) = 158 \text{ kg/m}^3$$

$$\text{Density of mustard stalk briquettes } (\rho_{\text{briquette}}) = 1134 \text{ kg/m}^3$$

$$\text{Calorific value of Mustard stalk (C.V)} = 3765.23 \text{ k Cal/kg}$$

$$\text{Thus the calorific value of 1 m}^3 \text{ of mustard stalk} = \rho_{\text{stalk}} \times \text{C.V}$$

$$= 158 \times 3765.23$$

$$= 594.906 \times 10^3 \text{ k Cal/m}^3$$

$$\text{Thus the calorific value of 1 m}^3 \text{ of mustard stalk briquette} = \rho_{\text{briquette}} \times \text{C.V}$$

$$= 1134 \times 3765.23$$

$$= 4269.77 \times 10^3 \text{ k Cal/m}^3$$

$$E_{\text{volumetric}} = \frac{4269.77 \times 10^3}{594.90 \times 10^3}$$

$$E_{\text{volumetric}} = 7.17 \text{ times}$$

Thus, it was found that there is increased in volumetric energy density of briquette by 7.17 times than that of raw mustard stalk. Thus briquette is a compact source of energy and convenient to handle, transport and storage than that of the mustard stalk

4.3.3.6 Specific energy consumption of Screw press machine

The specific energy consumption,

$$E = \frac{P_m \times 60}{Q}$$

The total power consumed by the briquetting machine is the power consumed by motors to run the machines, the power consumed by the heaters used for preheating and die heating. The total power consumed was 26 kW in briquetting process.

$$E = \frac{26 \times 60}{150}$$

$$E = 10.4 \text{ kJ/kg}$$

4.3.3.7 Effect of moisture on capacity of briquetting machine

Moisture content of the feed has been recognized as a critical factor in briquetting of biological materials. It is observed that from the experimentation that:

- i) They reduce the free surface energy of the solid and consequently increase its deformability under external constraints.
- ii) Adsorbed film can act as a boundary lubricant and enable the particles to rearrange themselves more quickly and efficiently into a dense & stable packing.
- iii) They will reinforce solid-solid adhesion forces in agglomerate by capillary forces, which tend to extend the field by interaction.

In case of excess water is present over the adsorbed film, the briquettes swell up and become loose. It was observed that blockage of die hole and jamming of the screw shaft took place at feed moisture levels above 40% of the feed. It was also observed that if the temperature is low and the passage of feed materials through die was possible then no stable briquette were formed. This was resulting in very poor briquetting capacity.

4.3.3.8 Effect of moisture content on briquetting efficiency

If the moisture is below certain optimum level, the feed simply passed through the dies or screws and no briquettes were formed, on the other hand, if the feed had more moisture than desired, briquettes were sometimes formed but mostly the material got stucked to the hopper, dies/screws etc. due to friction and cohesion resulting in insufficient compaction and ultimately briquetting efficiency reduced.

4.4 Evaluation of techno-economic of briquetting process.

4.4.1 Cost Analysis

Cost analysis of a briquetting plant is dependent highly on availability of biomass and site specific. Therefore, it is imperative that a feasibility report should be prepared for briquetting unit before its installation.

A cost analysis was made with mustard stalk which are available in dry form and do not therefore require drying prior to briquetting. The analysis was done by considering the present investment and the given assumption in the Chapter III.

The results obtained were enlisted in the table given below for economical analysis of the machine. It was observed that the investment of the machine was

achieved in 1.86 years only which is viable and feasible option. The total investment and possible achievable profit are given in the Table 4.10.

Cost Benefit Ratio (BCR)

The cost benefit ratio (BCR) was found to be 1.29 with a payback period of 1.86 years. It can be inferred that the developed briquetting machine was technically as well as economically feasible.

Table 4.11 Cash flow analysis for Cost benefit ratio and Payback Period

Production Capacity	150	Kg/h
Operating hr per day	8	h/day
Operating days per year	300	Days
Operating hours per year	2400	H
Capacity utilization	85	%
Raw material	Mustard stalk	
Briquettes produced	306	TPY
Infrastructural facilities		
Power	26	kW
Land area	4	m ²
Operational shed area	3	m ²
Briquetting storage (covered area)	3	m ²
Investments		
Installed cost of plant & machinery	1.31	Lakh
Land & building cost (Rs. 2000/- month rent)	0.24	Lakh
Total investment (A)	1.55	Lakh
Cost	Rs/ year	
Power @ Rs. 3.5 Per kWh	2.18	Lakh/year
Manpower @Rs 160 for two labour per day	0.48	Lakh/year
Maintenance @ 3 % of (A)	0.046	Lakh/year
Discount rate (@10 % for plant)	0.131	Lakh/year
Cost of production (B)	2.837	Lakh/year
Profitability	raw material	Free of cost
Net sale price of briquettes	Rs. 1200/-	Rs/tonne
Net sale price of briquettes per year (C)	3.672	Lakh/year

Net annual saving D=C-B	0.835	Lakh/year
NPW (Rs)	579882.6	Rs./- after 20 Year
Benefit Cost ratio (BCR) = C/B	1.29	
Payback Period = A/D	1.86	Year

4.4.2 Net present Worth

The net present worth for the machine was calculated on the basis of present investment and the interest rate considered for the machine and the profit achieved in each year. The life of machine was consider for 20 years thus the NPW for the briquetting machine was Rs. 579882.6/-. As well as the net present worth were calculated for next 20 years (Table 4.12).

Table 4.12 Net present worth of the briquetting

Year	Discount Rate (a)	Net Annual Saving (b)	Present Value Rs /-(a x b)
0	1	-131000	-131000
1	0.909091	83500	75909.09
2	0.826446	83500	69008.26
3	0.751315	83500	62734.79
4	0.683013	83500	57031.62
5	0.620921	83500	51846.93
6	0.564474	83500	47133.57
7	0.513158	83500	42848.7
8	0.466507	83500	38953.37
9	0.424098	83500	35412.15
10	0.385543	83500	32192.86
11	0.350494	83500	29266.24
12	0.318631	83500	26605.67
13	0.289664	83500	24186.98
14	0.263331	83500	21988.16
15	0.239392	83500	19989.24
16	0.217629	83500	18172.03
17	0.197845	83500	16520.03
18	0.179859	83500	15018.21
19	0.163508	83500	13652.92
20	0.148644	83500	12411.74
		NPW	579882.6

4.4.3 Internal rate of return

The IRR of the briquetting machine was calculated by using the formula given below. The internal rate of return for the briquetting of mustard stalk is calculated and found to be 64 % for 20 year. The higher percentage of the internal rate of return indicated the good economical return of the investment.

$$\sum_{t=1}^{t=n} \frac{B_t - C_t}{(1+i)^t} = 0$$

Table 4.13 Internal rate of return for mustard stalk briquetting project

Year	Cash Flow	62% Discount Factor		66% Discount Factor	
		Discount Factor	Present Value	Discount Factor	Present Value
0	-131000	1	-131000.00	1	-131000.00
1	83500	0.61728	51543.21	0.6024	50301.20
2	83500	0.38104	31816.80	0.3629	30301.93
3	83500	0.23521	19640.00	0.2186	18254.18
4	83500	0.14519	12123.46	0.1317	10996.49
5	83500	0.08962	7483.61	0.0793	6624.39
6	83500	0.05532	4619.52	0.0478	3990.60
7	83500	0.03415	2851.55	0.0288	2403.97
8	83500	0.02108	1760.22	0.0173	1448.18
9	83500	0.01301	1086.55	0.0104	872.40
10	83500	0.00803	670.71	0.0063	525.54
11	83500	0.00496	414.02	0.0038	316.59
12	83500	0.00306	255.57	0.0023	190.72
13	83500	0.00189	157.76	0.0014	114.89
14	83500	0.00117	97.38	0.0008	69.21
15	83500	0.00072	60.11	0.0005	41.69
16	83500	0.00044	37.11	0.0003	25.12
17	83500	0.00027	22.91	0.0002	15.13
18	83500	0.00017	14.14	0.0001	9.11
19	83500	0.00010	8.73	0.0001	5.49
20	83500	0.00006	5.39	0.0000	3.31
		NPV	3668.73	NPV	-4489.86
			IRR, %	64	

SUMMARY AND CONCLUSIONS

The results are summarised and concluded in this section for the better understanding of the research carried out.

- 1) Mustard stalk was selected and evaluated for property study. The estimated surplus mustard stalk was 7.01 MT. It was estimated that the moisture content, bulk density, calorific value and angle of repose of the mustard stalk was 4.875 %, 158 kg/m³, 3765.23 k Cal/kg and 39.8 degree respectively.
- 2) The proximate analysis of the waste like volatile matter, ash content and fixed carbon was 69, 13 and 18 % respectively.
- 3) The observed coefficient of friction of the mustard stalk on different platform like mild steel, stainless steel, galvanised iron, aluminium and plywood sheet was 0.531, 0.383, 0.487, 0.531 and 0.466 respectively.
- 4) Ultimate analysis of the mustard stalk was giving the information of the constituents of the biomass like carbon, hydrogen, oxygen, sulphur, nitrogen and ash were 45.17, 5.15, 42.92, 0.14, 0.75 and 5.87 % respectively.
- 5) Similarly the chemical property of mustard like lignin and cellulose were 23.5 and 52.5 % respectively.
- 6) Thermo gravimetric Analyser (TGA) of the mustard stalk gives a detail idea about the weight loss of residue with respective rise in temperature and time. It is observed that there is significant weight loss of residue from 25 mg to 15 mg w.r.t of temperature gradient of 100-120 °C and in the time span of 10 min.
- 7) Design of screw press briquetting machine was done on the basis of this property details. The design screw diameter was 102 mm with a pitch of 32mm and overall length of 550 mm. Design machine is of 150 kg/h capacity operated with 15.87 kW of motor with the help of belt and pulley drive.
- 8) The die of 90 mm diameter and 210 mm long was used to prepare the briquette.
- 9) The preheating system consist of a screw conveyer operated with 2 hp motor with an screw diameter of 250 mm and 1250 mm long was developed for heating of biomass upto 120 °C to produced durable briquette.
- 10) Output briquette of the screw press was of 80 mm diameter with a concentric hole of 25 mm was obtained with bulk density of 1137 kg/m³.

- 11) The briquette properties like radial compressive strength, durability, shatter index, water resistance and stability were evaluated and found to be 15.75 kgf/mm², 70%, 4200, 50min and highly stable.
- 12) The briquetting parameters like die temperature, preheater temperature, and production potential were studied with achieved density.
- 13) The economic evaluation of the briquetting was also done. The net present worth, cost benefit ratio and payback of the machine was found to be Rs. 579882.6/-, 1.29 and 1.86 years.

Conclusions

- 1) Availability of different type of biomass, its product to residue ratio and its present uses in Rajasthan state were presented in the study.
- 2) The potential of available biomass, surplus biomass and mustard stalk were presented in the study.
- 3) Study of properties of mustard stalk was done for easy understanding of behaviour of mustard stalk and its utility for briquetting.
- 4) The mustard stalk was found suitable for binder less briquetting because of high lignin content and low ash content.
- 5) The screw press briquetting machine of 150 kg/h capacity was developed to utilize the mustard stalk as fuel to produce briquettes.
- 6) The preheating system suitable to the 150 kg/h capacity was also developed with mica band heaters. In the briquetting process mustard stalk was heated up to 120 °C temperature for lignin flow as binder.
- 7) The briquette of 80 mm diameter with a concentric hole of 25 mm and variable length of 110 – 210 mm was produced from the designed briquetting machine.
- 8) The mustard stalk briquettes were found durable due to high bulk density and low moisture content.
- 9) The mustard stalk briquette produced was more stable and having moderate water resistance and shatter index.
- 10) The techno-economic evaluation of machine was done and found that the machine overall efficiency was good while the preheater was highly efficient. The net present worth, Benefit cost ratio and payback of machine was very attractive.

SUGGESTIONS FOR FUTURE WORK

The following suggestions were made for improvement of the present work and scope of related work.

- 1) The performance of the briquetting machine with variable speed drive mechanism has to be evaluated.
- 2) Long term test of machine has to be done.
- 3) Different biomass having characterisation similar to mustard stalk has to be tested with desire temperature for briquetting.
- 4) Performance evaluation of down draft gasifier using developed briquettes can be done.

REFERENCES

- Akdeniz R C; Mustafa A and Arif H (2004), Cotton stalk as a potential energy source, *Energy Sources*, Vol. 26 :65-75.
- Alam, A. (2000). Biomass conversion process for energy application. *J. Bioenergy*, 1(1): 15–23.
- Amaya A., Medero N., Tancredi N., Silva H., and Deiana C. (2007). Activated carbon briquettes from biomass materials. *Bio-resource Technology*. 98(8):1635-41.
- Andrzej Krauss; Waldemar Szymanski (2006), Briquetting of lignocellulose waste in perpetual screw briquetting machine. *Wood Technology*. Vol. 9(3) Article 13: 22-24
- Anon (1987), The Briquetting of agricultural wastes for fuel. CRA: 22-124.
- Anon (1997). Biomass Briquetting. Royal Nepal Academy of Science and Technology (RONAST): 45-49.
- Anon, (2003), Guidebook for fabrication and building: improved biomass briquetting systems and improved biomass stoves. Department of Rural Energy Planning and Fuels Institute of Energy, Vietnam.
- Anonymous, (1999). Biomass gasifier. Seminar on renewable energy 2000 held at Coimbatore, Tamilnadu, 157-64.
- ASAE Standards S269.4. (1998), Cubes, Pellets and Crumbles-Definitions and Methods for Determining Density, Durability and Moisture Content. ASABE, 2950 Niles Rd., St. Joseph, MI 49085-9659, USA ph. 269-429-0300, fax 269-429-3852. hq@asae.org
- Bellinger, P. L. and McColly, H. (1961). Energy Requirements for Forming Hay Pellets. *Agricultural Engineering*. 42 (5,6):180-181.
- Bhat, A., Bheemarasetti, T. And Rajeswara R. (2001). Kinetics of rice husk gasification. *Energy conservation and management* (42): 2061-69.

- Bhattacharya, S.C. (1989), State of the Art of Biomass Densification. Division of Energy Technology. Energy Sources, N. Y., Taylor and Francis. 11 (3):161-186.
- Bhattacharya, S. C. Siddique, A. H. Md. M. R. Leon, M. A. Pham, H. L. and Mahandari, C. P. (1999), A study on improved institutional biomass stoves. ISES 99 Solar World Congress, Israel, 4-9 July 1999.
- Bhattacharya, S. C. Albina, D. O. and Khaing, A. M. (2002). Effects of selected parameters on performance and emission of biomass-fired cook stoves. *Biomass and Bioenergy* **23**: 387-395. www.elsevier.com
- Bhattacharya, S. C. Leon, M. A. and Rahman, M. M. (2002). A study on improved biomass briquetting. *Energy for Sustainable Development* **6**.
- Bhattacharya, S. C. (2003). Commercialisation options for biomass energy technologies in ESCAP countries. *International Journal of Energy Technology and Policy* **1**: 363 – 399. www.inderscience.com
- Bhattacharya, S. C. and Kumar, S. (2005). Technology Packages: Screw-press briquetting machines and briquette-fired stoves. Manual published by Regional Energy Resources Information Centre, AIT, Thailand.
- Brandt H. J. (1988), Biomass Densification: Densification in Thailand. A Prefeasibility study. Thesis submitted to Department of Mechanical Engineering, University of Twente.
- Brandt H. J. (1990), Biomass Densification Research Project, Phase one, Main Report, Technology and Development Group, Enschede, The Netherlands.
- Car and Hartog J. (1984) A new densification Process – Original Use of the final Product, Biomass Conversion, Elsevier Applied Science Publishers, London.
- Choudhary S. (1986). Briquetting of Biomass. A techno-economic analysis. Proc. of national workshop on briquetting of organic residue, National Productivity Council, New Delhi.
- Dayal M (1985), Bio-Energy: Present status and future prospective, Proceeding of bio-energy society, First Convention and Symposium 84. Bio-Energy Society of India, New Delhi.
- Demirbas, A. and Simsek T. (2006), Effect of polymerization and briquetting parameter on the tensile strength of briquettes formed from coal coke and aniline-

- formaldehyde resin. *Energy Sources part A*, **28**: 1321 – 1328. Published by Taylor & Francis Group. online@tandf.co.uk
- Demirbas, A. Demirbas, A. S. and Demirbas, A. H. (2004), Briquetting properties of biomass waste materials. *Energy Sources* **26**: 83 – 91. Published by Taylor & Francis Group. online@tandf.co.uk
- Eriksson, S. and Prior, M. (1990), The Briquetting of Agricultural Wastes for Fuel. FAO Environment and energy paper 11. FAO, Via delle Terme di Caracalla, 00100 Rome, Italy.
- Fabienne R.; Michae T.; Thorsten B., Hans H, Peter D J, Josef R, Juan C, Miguel F, (2006). Particle density determination of pellets and briquettes. *Biomass and Bioenergy* Vol. 30 : 954–963 .
- Gangde, C. N., Patil N. E., Madansure, V. N. And Chaudhary, A. A. (1998). Characterization of biomass fuels for gasification. *PKV Research Journal*, 22 (1):101-04
- Goering H D and Van Soest, P J (1975) Forage fiber analysis U S Department of agriculture, Agricultural Research Service Washington DC.
- Granada, E. Gonzalez, L. M. L. Miguez, J. L. and Moran, J. (2002), Fuel lignocellulosic briquettes, die design and products study. *Renewable Energy* **27**:561-573, www.sciencedirect.com
- Grover P D (2004) Characterization of biomass for energy generation. *Biomass Management for energy purposes – issues and strategies, Proceedings of the national seminar*, SPRERI, Anand, Gujarat: 134-174.
- Grover P. D. (1990), Country study on status of biomass densification in India, University of Twente, The Netherland.
- Guillermo, M. H. Miguel, G. V. and Pedro, Y. 2002. Extruder design to elaborate animal feed from crop residues. ASAE Annual Meeting Report, published by American Society of Agricultural and Biological Engineers, Paper number 026133, www.asabe.org
- Gunter Frank and Nache A. K. (1984). Compaction of biomass by Extrusion Presses. Proc. Of BioEnergy 84 Vol. III Biomass Conversion, Elsevier Applied Science Publishers, London.

- Gusain P. S. (1986) Briquetting of Biomass On small Scale Technology and Economics, Proc. of national workshop on briquetting of organic residue, National Productivity Council, New Delhi.
- Hall D O, Rosillo-Calle F, Woods J (1991). Biomass, its importance in balancing CO₂ budgets. In: Grassi G, Collina A, Zibetta H, editors. Biomass for energy, industry and environment, 6th E.C. Conference Elsevier Science, London, : 89-96
- Hall, D.O, Rosillo-Calle, F, Williams, R.H and Woods, J. (1993), Biomass for Energy - Supply Prospects, in Renewable Energy- Sources of Fuels and Electricity - Johansson T.B, Kelly H, Reddy A.K.N and Williams R.H (Eds.), Island Press, Washington D.C., U.S.A.
- Henderson (1996) Agricultural Process Engineering, Text book, New Delhi: 213-216
- Isaac Bamgboye and S. J. Bolufawi (2009) physical characteristics of briquettes from guinea corn (sorghum bi-color) residue agricultural engineering international: The CIGR Ejournal. Manuscript 1364.
- Jorapur R. M, and Rajvanshi A. K. (1995). Development of a sugarcane leaf gasifier for electricity generation . Biomass and Bioenergy. 8 (2): 91-98.
- Jorapur, R., and Rajvanshi, A. K. (1997). Sugarcane leaf-bagasse gasifiers for industrial heating applications. *Biomass and bioenergy*.13(3) 141-46.
- Juri Olt and Mihkel Laur (2009). Briquetting different kinds of herbaceous biomaterial. Engineering for Rural Development: 225- 228.
- Karaosmanoglu, F. Tetik, E. Gurboyl, B. and Sanli, I. (1999). Characterization of the straw stalk of the rapeseed plant as a biomass energy source. *Energy Sources* 21: 801-810. Published by Taylor & Francis Group online@tandf.co.uk.
- Karve P., Mahajan H. Y., Salunkhe R. M., Karve A. D. (2001). A chain of technologies using for sugarcane trash as a household fuel. Household Energy and Enterprise 47.
- Kennedy, Z. R. And. Lukose, T. P (2006). Performance evaluation of a double-walled downdraft gasifier for energy applications. *Advances in energy research*.
- Khurmi R S & Chandra S, (2008). A text book of Engineering Mechanics, Multi colour Edition: 675-680.

- Koopmans, A., and Heruela, C. (1999). Trends in wood, biomass and other energy sources. *Wood Energy News*. 14(3):6.
- Lindley, J.A. and Vossoughy, M. (1989). Physical Properties of Biomass Briquettes. *Transactions of the ASAE*. 32(2):361-366.
- Mathur A N, Rathore N S and Kothari S (1991), A study on Densification of Prosopis Juliflora for Utilization as efficient fuel, Proceeding of second National Meet/ PICCOP Meet on advances in biomass Gasification Technology, Editor KK Singh, A. N Mathur and N S Rathore, Himanshu Publication, Udaipur.
- Mohan A (1986). Marketing of Briquetted Fuel for Industrial Sector. Proc. Of national workshop on briquetting of organic Residue, National Productivity Council, New Delhi.
- Moral, N. A. (2005). Biomass briquetting machine (Electrical and diesel system) design, construction and operation manual. *Renewable Energy Technology in Asia, Phase -III*, BIT Khulna, Bangladesh.
- Munoz, M., Moreno, F., Morea, R. J., Ruiz, J. And Arauzo, J. (2000). Low heating value gas on spark ignition engines. *Biomass and Bioenergy*. 18: 431-39.
- Munoz-Hernandez G., J. Dominguez-Dominguez, and O. Alvarado-Mancilla (2006), "An Easy Laboratory Method for Optimizing the Parameters for the Mechanical Densification Process: An Evaluation with an Extruder". *Agricultural Engineering International: The CIGR E-journal*. Manuscript PM 06 015. Vol. VIII. July.
- Noordman Marcel (1992). Technology Fit within briquetting Plants in India, IIT Delhi, University of Twente Report.
- Papneja, A S (1986). Development of appropriate briquette making machine suitable to Indian conditions, Proc. Of National Workshop On Briquetting Of Organic Residue, National Productivity Council, New Delhi.
- Parikh, P. P., Bhave, A. G. Kapse, D. V. And Shashikantha, (1989). Study of thermal and emission performance small gasifier dual fuel engine systems. *Biomass*. 19:75-77.
- Pathak P S, Khan T A and Sharma P (2004) Biomass Production, Its utilization and surplus for energy generation in India. *Biomass Management for energy purposes*

– issues and strategies, *Proceedings of the National Seminar*, SPRERI, Anand, Gujarat: 10-35.

Patil, K. N. And Singh, R. N. (2001). Field evaluation of biomass natural draft gasifier based hot water system. *SESI Journal*. 11(1): 83-90.

Phirke P S (2004) Processing and Conveying Equipment Design, Text Book, Jain Brothers, New Delhi : 216-227.

Purohit, P. Tripathi, A. K. and Kandpal, T. C. (2006) Energetics of coal substitution by briquettes of agricultural residues. *Energy* 31: 1321-1331.

Rajvanshi, A. K. And M. S. Joshi, (1989). Development and operational experience with topless wood gasifier running a 3.75 kW diesel engine pumpset. *Biomass*. 19: 47-56.

Rama Rao and Kodna P. (1986). Prospects, problems and prospectives in marketing briquetted fuel, proc. Of national workshop on briquetting of organic residue, National productivity council, New Delhi.

Rathore N. S; Panwar N. L. and Kothari S. (2007). Biomass production and utilisation technology: 56-58.

Rathore, N. S., Kurchania, A. K., and Panwar, N. L. (2006). Non conventional energy sources. 180-202.

Ravindranath N. H. and Hall D.O (1995), *Biomass Energy and Environment- A Developing Country Perspective from India*, Oxford University Press, Oxford.

Reed T and Bryant B (1978) Densified biomass: A new form of solid fuel, SERI Report 35. The Solar Energy Research Institute, Golden, CO 80401, US.

Reed, T. B., G. Trezek and L. Diaz. (1980). Biomass Densification Energy Requirements. In *Thermal Conversion of Solid Wastes and Biomass*, 189 – 177. Washington, D. C.: American Chemical Society.

Rieschel, H. (1977). Various types of briquetting presses and their applications, edited by H.C. Menssmen and T.E. Tibbets. Montreal, Quebec: Institute for briquetting and Agglomeration : 78-90.

Saeidy, E. E. and Mlynek, J. (2004). Technological fundamentals of briquetting cotton stalks as a biofuel. Ph. D. Dissertation, Renewable Energy in Agriculture in

- Egypt, Department of Post-Harvest Technology, Institute of Agricultural Engineering, (ATB) Humboldt University, Berlin, Germany.
- Sathitruangsak, P. Madhiyanon, T. and Soponronnarit, S. (2006). Design of an extrusion screw and solid fuel produced from coconut shell. *Songklanakarin Journal of Science and Technology* **28**: 387-401.
- Shakya G. R and Shakya I.; (2000) Salient Features of Biomass Briquetting in Nepal. International Energy Journal-Special Issue: Renewable Energy Sources in Nepal, Renewable Energy Resources Information Centre, Asian Institute of Technology, Thailand
- Shakya G. R., Shakya I and. Augustus Leon, M (2005) Biomass briquetting of agricultural and forest residues and herb wastes in Nepal. Royal Nepal academy of science and technology, Kathmandu Nepal.
- Sharma S. (2005). Bio-briquette: A potential source of biomass based energy. *ASHAD*. (46):2065.
- Singhal O.P. (1987). Briquetting of Organic Residues. *Journal of Steam and Fuel Users*, Vol. XXXVI No. 4.
- Shukla, P.R (1997) Biomass Energy Future for India. Paper Presented in International Workshop on “Science and Technology for a Modern Biomass Civilization”, Brazil. <http://www.e2analytics.com>
- Singh, K.K., Mathur, A.N. and Rathore, N. S. (1990). Advances in biomass gasification technology. Proc. Of IIND National Meet / Piccop Meet, Himanshu Publications, Udaipur, India, December 20–21, 1990.
- Singh, R. N. Sharma, A. M. and Bhoi, P. R. (2006). Studies on storage and use of biomass briquettes in combustion and gasification reactor. *Journal of Agricultural Engineering* **43**: 61-65.
- Sirisomboon, P. (1991). Estimation of higher heating value of biomass in tropical regions. *AMA*. 22(2): 81-84.
- Srivastava¹ P. K., Maheshwari, R. C. and Ojha T. P. (1986 a), Comparative Performance of small scale Briquetting Unit, Proceeding of National Workshop on Briquetting of Organic Residue, National Productivity Council, New Delhi.

- Srivastava² P K, Maheshwari, R. C. and Ojha T. P. (1986), Prospects and Technologies for Briquetting of Biomass, Proceeding of National Workshop on Briquetting of Organic Residue, National Productivity Council, New Delhi.
- Srivastava P K, Maheshwari, R. C. and Ojha T. P. (1990), Design, Development and Testing of Charcoal Briquetting Machine, Proceedings of XXVI Annual Convention of Indian Society for Agricultural Engineers.
- Steverson, E.M. Semler, T.T. and Goldsberry, J.A. (1985). An Evaluation of Densification Technologies. 1EG&G Idaho, Inc. Prepared by U.S. Department of Energy Washington, D.C. 20555. Under DOE Contract No. DE-AC07-76IDO1570. DE86 002326
- Tadtiyanant, C., Lyons, J. J. and Vandepopulibre, J. M. (1993). Extrusion Processing Used to Convert Dead Poultry, Feathers, Eggshells, Hatchery Waste and Mechanically Deboned Residue into Feedstuffs for Poultry. Department of Animal Sciences, University of Missouri, Columbia, Missouri 65211.
- Talib, A., Goss, J. R., Flanigan, V. J., Grsover, P. D., Mathur, H. B., and Durgaprasad, M. B. (1989). Development and field testing of small biomass gasifier-engine systems in India: A Joint Project by an American and Indian Team. *Biomass*. 19: 99-122.
- TIDE (1992). Vol. 2 No. 4, Dec. 1992.
- Toan, P. K. Cuong, N. D. and Leon, M. A. (2004). Activities and achievements of a biomass briquetting. Final Project Report submitted in Vietnam.
- Toan, P. K. Cuong, N. D. And Leon, M. A. (2004). Activities and achievements of a biomass briquetting. Final project report submitted in vietnam.
- Toan, P. K. Cuong, N. D. Quy, N. T. and Singh, P. K. (2000). Application of briquetting technology to produce briquettes from agricultural residues and by-products. Institute of Energy. Asian Institute of Technology (AIT), Bangkok.
- Tripathi, A. K., Iyer, P. V. R. And Kandpal, T. C. (1999). Biomass gasifier based institutional cooking in India: A preliminary financial evaluation. *Biomass and bioenergy*. 17(2):165-73.

- Van T. Pelt. (2003). "Maize, Soybean, and Alfalfa Biomass Densification", *Agricultural Engineering International: the CIGR Journal of Scientific Research and Development*. Manuscript EE 03 002. May, 2003.
- Vasudevan R. (1993). *Briquetting of Agricultural Residues, Problems and Imperatives*, IREDA News, New Delhi, Vol. 4 (2).
- Vimal O. P. and Bhatt M. S. (1989), *Wood Energy Systems*, K. L. Publication, New Delhi: 68-79.
- Wilaipon P (2002). The effect of moderate die pressure on maize cob briquettes: A case study in Phitsanulok, Thailand. *Proceedings of the International Conference on Village Power from Renewable Energy in Asia*, November 11-14, Phitsanulok, Thailand.
- Xianyang Z., Yitai M., Lirong M. (2007). Utilization of straw in biomass energy in China. *Renewable and Sustainable Energy Reviews*. Vol. 11: 976–987
- Yang, W., Ponzio, A., Lucas, C. And Blasiac, W. (2006). performance analysis of fixed bed biomass gasifier using high temperature air. *Fuel processing technology*. 87: 235-45.
- Yousif A. Abakr, Ahmed E. Abasaheed (2006). Experimental evaluation of a conical-screw briquetting machine for the briquetting of carbonized cotton stalks in Sudan. *Journal of Engineering Science and Technology* vol. 1, no. 2:212- 220
- Zohns, M.A. and Jenkins, B.M. (1986). An Automatic Laboratory Apparatus for Densification of Particulate Materials. ASAE paper No. 86-6578. 1986 Winter Meeting of ASAE. ASAE, St. Joseph, MI.

Abstract

Rajasthan having total surplus biomass potential of 40 MT with a contribution of mustard stalks of 7.1 MT. As mustard was not useful for any other purpose it was very difficult to dispose the mustard stalk waste. The regular practise of burning is not an efficient solution thus the Mustard stalk was utilised for production of briquettes as an energy fuel. The crops to residue ratio of different biomass were also listed in the research carried out. The properties study of mustard stalk was carried out for the details estimation of characteristics of mustard stalks. The mustard stalk characteristic like bulk density, calorific value and angle of repose were carried out during the study was 158 kg/m³, 3765.23 kcal/kg, 39.8 degree. It was observed that the raw mustard stalk having a coefficient of friction of 0.531 on mild steel and aluminium sheet was less than the values on stainless steel, galvanised iron and plywood sheet. The thermogravimetric analysis of mustard was giving the details of weight loss of material with time and temperature for mustard stalk. The lignin content of the mustard was found to be 23.5 % with cellulose of 52.5 %. The ultimate and proximate analyses of mustard stalk were also done during the study.

The screw press briquetting machine was design and developed for 150 kg/h capacity. Detail design calculation of screw, drive power required, pulley design, and required speed were done for screw press briquetting machine. The drive power of 20 hp motor was used to get the 7.1 time denser briquette through this developed screw press. Beside of this the preheating system design was also done for the mustard stalk and parameter for the desired temperature and speed of conveyer. Biomass heating was an efficient route of lignin flow in case of binder less briquetting thus the mustard stalk was heated to the temperature of 120⁰C in the preheater followed by the die heating during briquetting.

The briquette of 80 mm diameter and 110mm length was produced with a 25 mm concentric hole in between using developed screw press. The characteristics of mustard stalk briquette produced were also carried out at the end of the study. The properties of briquettes like bulk density, durability, radial compressive strength, water resistance and shatter index were found to be of 1134 kg/m³, 70.22 %, 15.75 kgf/mm², 50 min, and 4200. It was also found that the briquette formed during the experimentation was stable.

The briquetting machine efficiency, heater efficiency and volumetric energy density were calculated on the basis of power consumed and the out put energy, and

volumetric change in density after briquetting. The economic analysis of the briquetting process was evaluated for the net present worth, benefit to cost ratio and payback of the system and found to be Rs. 579882.6 /- after 20 years, 1.29 and 1.86 years respectively.

अनुक्षेपण

राजस्थान राज्य में कुल कृषि अवशेष लगभग 40 मैट्रिक टन उपलब्ध है जिसमें से 7.1 मैट्रिक टन सरसो अवशेष का हिस्सा है। सरसों अवशेष किसी कार्य हेतु उपयोगी नहीं होने से इसका निस्तारण करना बड़ी समस्या है। इसे सामान्यतः जलाने में उपयोग किया जाता है एक दक्षतापूर्ण विकल्प है। अतः ब्रिकेट्स उत्पादन कर ऊष्मा ईंधन हेतु इसका उपयोग किया गया है। सभी फसलों एवं इनके कृषि अवशेष का अनुपात भी इस शोध कार्य में प्रस्तुत किया गया है। सरसों कटाई उपरान्त प्राप्त अवशेष हेतु विस्तृत आंकलन किया गया। इसके विशिष्ट गुणों में घनत्व, ऊष्मीयमान तथा रिपोस् कोण का मान 158 किग्रा/घ.मी., 3756.23 किलोकैलोरी/किग्रा एवं 39.8 डिग्री मापा गया।

सरसों के थर्मो-गिविमेट्रीक आंकलन से समय एवं तापक्रम के साथ उसके भार में कमी का विस्तृत विवरण मिल सका। सरसों में लिग्निन (रेशेदार प्रदार्थ) की मात्रा 23.5 प्रतिशत आंकी गई जिसमें 52.5% सेल्यूलोस था। परीक्षण के दौरान सरसों अवशेष का अंतिम एवं प्रारम्भिक आंकलन भी किया गया।

150 किग्रा/घंटा क्षमा की स्क्रू प्रेस ब्रीक्वेटिंग की रूपरेखा बनाई एवं विकसित की गई। स्क्रू प्रेस ब्रीक्वेटिंग मशीन की विस्तृत रूपरेखा के लिए स्क्रू मशीन चालने हेतु आवश्यक शक्ति, चरखी/घिरनी की रूपरेखा एवं आवश्यक गति की गणना भी गई। इस विकसित की गई स्क्रू प्रेस द्वारा 7.1 गुना घना ब्रीक्वेट पाने हेतु 20 हार्सपावर की शक्ति वाली मोटर काम में लाई गई। इसके अलावा, सरसों अवशेष की लिए पूर्व ऊष्मा देने हेतु कार्यप्रणाली की रूपरेखा बनाई गई एवं इसका मूल्यांकन कन्वेयर के मनचाहे तापमान व गति के लिए किया गया। बाइन्डर के बिना ब्रीक्वेटिंग करने की स्थिति में लिग्निन के प्रवाह के लिए कए जैविक अवशेष को गर्म करना एक सक्षम राता है। अतः ब्रीक्वेटिंग के दौरान सरसों के अवशेष को पहले पूर्व ऊष्मक में 120° से.ग्रे. तक गर्म किया उसके बाद स्थिर तापमान पर गर्म किया।

विकसित की गई स्क्रू प्रेस के 25 मि.मी. के केन्द्रीय छिद्र द्वारा 80 मि.मी. व्यास व 110 मि.मी. लम्बाई के ब्रीक्वेट का उत्पादन किया गया। शोध के दौरान सरसों के अवशेष एवं बनाए गए ब्रीक्वेट के चारित्रिक गुणों का अध्ययन किया गया। ब्रीक्वेट की Properties जैसे कि परिणाम घनत्व, स्थिरता, किरण संबंधी दबाव योग्य शक्ति, जल अवरोध एवं छितराए अंशों की सूची क्रमशः 1134 किग्रा/घनमीटर, 70.22%, 15.75 किग्रा/वर्त मि.मी., 50 मिनट एवं 4200 रही। यह भी पाया गया कि शोध के दौरान बनाए गए ब्रीक्वेट स्थिर थे।

Appendix I

Data for typical allowances made for motor efficiency

P_m (kW)	δ
0.4 0.75 1.5	0.4
2.2 3.7	0.4 ~ 0.25
5.5 7.5 11 15 18.5 22 30 37	0.25 ~ 0.15
45	0.15 ~ 0.10

Appendix II

Data for percent slip of different types of electric motors

kW	<i>s</i> (%)					
	2 P		4 P		6 P	
		E		E		E
0.2	9.5	10.0	10.0	10.5		
0.4	8.0	8.5	8.5	9.0	9.5	10.0
0.75	7.0	7.5	7.5	8.0	8.0	8.5
1.5	6.5	7.0	7.0	7.5	7.5	8.0
2.2	6.0	6.5	6.5	7.0	6.5	7.0
3.7	5.5	6.0	6.0	6.5	6.0	6.5
5.5	5.5	6.0	5.5	6.0	5.5	6.0
7.5	5.5	6.0	5.5	6.0	5.5	6.0
11	5.0	5.5	5.5	6.0	5.5	6.0
15	5.0	5.5	5.0	5.5	5.5	
(19)	5.0		5.0		5.0	
22	4.5		5.0		5.0	
30	4.5		5.0		5.0	
37	4.5		5.0		5.0	

Appendix III

CROSS SECTION SELECTION CHART

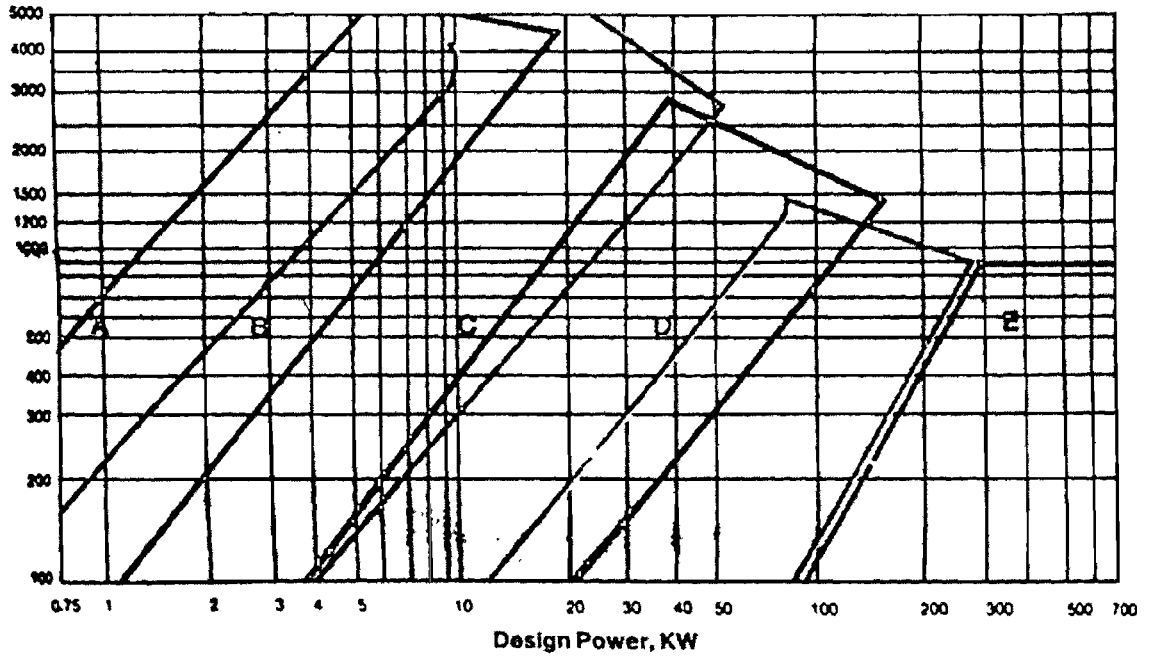

Appendix IV

Total expenditure for fabrication of Briquetting machine with Preheater (as on Jan 2008)

Sr. No.	Parts	Quantity (Nos.)	Material	Cost Rs./-
Tender A : Fabrication of machine parts including material				
1	Die	1	MS Round	3500
2	Flange	1	MS Sheet	1350
3	Main Shaft	1	MS Round	4000
4	Screw	1	MS Sheet	10000
5	Bearing Cover	1	MS Sheet	600
6	Cooling Plate	1	MS Sheet	1200
7	Bearing Housing	1	MS Sheet	4500
8	Screw Housing	1	MS Sheet	9000
9	Hopper	2	MS Sheet	3070
10	Preheater Drum	1	MS Sheet	5000
11	Screw Conveyer	1	MS Round + Sheet	7000
	Total			49220
Tender B: Supply of ISI marked Motor and others as per specification and requirement				
12	Pulley	4	MS 4 no.	8000
13	Bearing	4	MS 4 no.	2000
14	Motor	1	20 hp-AC-960 rpm	21000
15	Motor	1	2 hp- AC-1500 rpm	7500
16	DC drive	1	Up to 50 rpm	5500
17	Motor starter	1	for 20 hp motor	3500
	Total			47500
Tender C: Heating unit including accessories				
18	Preheater Heating unit	1	Mica Band Heaters	15000
19	Stand	4	MS Angle	4000
	Total			19000
20	S F Unit	1	63 amp	3,000

21	HRC Fuse with Base	9	32 amp	1,800
22	Wiring	2 coil	16 Sq. mm	3,000
23	Cable	10 meter	16 Sq. mm	1,200
24	V belt	1"	2 No.	400
	Total			9,400/-
20	Die Heater	1	Mica Band Heaters	1136
21	Die material	1	M S Rod	1362
	Total			127618
Heater and Die material				
1	Die Heater	1	1kW	1136
2	Die material (MS solid rod)	1	20 kg	2362
	Total			3498
	Grand total			131116

