



सत्यमेव जयते

INDIAN AGRICULTURAL
RESEARCH INSTITUTE, NEW DELHI.

I. A. R. I. 6.

MGIPC—S1—51 AR/57—3-4-58—5,000.

SMITHSONIAN MISCELLANEOUS COLLECTIONS

VOLUME 85, NUMBER 6

MORPHOLOGY OF THE INSECT ABDOMEN

PART I. GENERAL STRUCTURE OF THE ABDOMEN AND ITS APPENDAGES

BY

R. E. SNODGRASS ✓

Bureau of Entomology,

U. S. Department of Agriculture



(PUBLICATION 3124)

CITY OF WASHINGTON
PUBLISHED BY THE SMITHSONIAN INSTITUTION
NOVEMBER 6, 1931

The Lord Baltimore Press
BALTIMORE, MD., U. S. A.

MORPHOLOGY OF THE INSECT ABDOMEN

PART I. GENERAL STRUCTURE OF THE ABDOMEN AND ITS APPENDAGES

By R. E. SNODGRASS

BUREAU OF ENTOMOLOGY

U. S. DEPARTMENT OF AGRICULTURE

CONTENTS

| | PAGE |
|--|------|
| Introduction | I |
| I. The abdominal sclerotization..... | 6 |
| II. The abdominal segments..... | 14 |
| The visceral segments..... | 16 |
| The genital segments..... | 17 |
| The postgenital segments..... | 19 |
| III. The abdominal musculature..... | 28 |
| General plan of the abdominal musculature..... | 31 |
| The abdominal musculature of adult Pterygota..... | 42 |
| The abdominal musculature of endopterygote larvae..... | 48 |
| The abdominal musculature of Apterygota..... | 56 |
| IV. The abdominal appendages..... | 62 |
| Body appendages of Chilopoda..... | 65 |
| Abdominal appendages of Crustacea..... | 68 |
| The abdominal appendages of Protura..... | 70 |
| General structure of the abdominal appendages of insects..... | 71 |
| The abdominal appendages of Collembola..... | 72 |
| The abdominal appendages of Thysanura..... | 74 |
| The abdominal gills of ephemerid larvae..... | 77 |
| Lateral abdominal appendages of sialid and coleopterous larvae.... | 79 |
| The abdominal legs of lepidopterous larvae..... | 83 |
| The gonopods | 88 |
| The cerci (uropods)..... | 92 |
| The terminal appendages of endopterygote larvae..... | 96 |
| Terminal lobes of the paraprocts..... | 107 |
| Morphology of the abdominal appendages..... | 108 |
| Abbreviations used on the figures..... | 122 |
| References | 123 |

INTRODUCTION

The incision of the insect into head, thorax, and abdomen is in general more evident in the cervical region than at the thoracico-abdominal line; but anatomically the insect is more profoundly divided between the thorax and the abdomen than it is between the head and

the thorax. The series of segmental appendages is continuous, and uniform except for minor adaptational modifications, from the head to the metathorax, inclusive; on the abdomen the appendages abruptly cease, or are greatly altered in form. The musculature of the abdomen, consequently, is sharply differentiated from that of the thorax. Even the respiratory mechanism attests that the thoraco-abdominal boundary marks some deep-seated change in the body organization, since the closing apparatus of the spiracles is almost invariably different in one way or another before and behind the intersegmental fold separating the thorax from the abdomen. The definitive head contains three segments that have been, comparatively speaking, but recently transferred from the body to the cephalic region; the waist line of the insect has long been definitely established, and only in a single order has an abdominal segment been given over to the thorax. The abdomen is distinctly the visceral region of the body, and its major active functions in adult insects are those of respiration, copulation, and oviposition.

Yet, notwithstanding the functional and structural differences that have come to separate the insect body into cephalothoracic and abdominal regions, we can not avoid the assumption that modern insects are derived from polypod ancestors, and that the abdominal segments at some time in the past history of the Hexapoda had the same essential structure as that of the primitive thoracic and gnathal segments. In studying the morphology of the abdomen and its appendicular organs, therefore, we must attempt to find in the modern structure a basic plan of organization the same as that we are led to believe exists in the cephalic and thoracic regions from a study of the segments, the appendages, and the musculature in the preabdominal parts of the body. Considering, then, the nature of the task, it is not surprising that students of insect morphology find in the abdomen problems far more difficult of solution than are those encountered in the head or thorax, and that there are many fundamental problems in the abdomen which are still unsolved.

To the systematist in entomology the study of the abdomen, or particularly of the genital appendages, is becoming of ever increasing importance, and specialists are coming to feel acutely the need of a fundamental understanding of the organs that have been found in so many cases to give the best characters by which species may be distinguished. Unfortunately, however, no investigator has yet discovered a means for determining with certainty the homologies of the organs most useful for diagnostic purposes. In truth, we may say that the

morphology of the insect abdomen is a field in which no angel yet has trod, and is, therefore, one in which the fool unhindered may achieve his destiny. However, it is reputed that there is some merit in knowing oneself to be a fool, and, if it is the wisdom of the wise to enter only where the foolish have sprung the trap, the fool at least has a mission to perform. Hence, the writer offers the generalizations contained in this and a second paper to follow, not with the conviction that they will prove infallible, but in the hope that others will try to disprove them—and thereby establish their value.

The principal conclusions derived from the study of the abdomen and its appendages to be given later in detail may be itemized in advance as follows:

1. The insect abdomen consists primarily of 12 segments, the first 11 of which are true somites, while the last is the periproct, or telson.

2. The twelfth segment is practically obliterated in all the true Insecta, except for possible remnants in larval Odonata.

3. The eleventh somite becomes the functional anal segment with the suppression of the twelfth segment. Its tergum forms the epiproct. The venter of the eleventh segment is distinct in some Thysanura, but it is usually reduced or obliterated, except for two terminal lobes, which are the paraprocts. The appendages of the eleventh segment are the cerci.

4. The tenth segment is usually distinct in generalized insects, but it is often combined with the eleventh to form a composite terminal segment. The embryonic appendages of the tenth segment are suppressed in postembryonic stages of the more generalized insects; they form the postpedes of holometabolous larvae, and perhaps the appendicular processes of the proctiger, or tenth segment, of some adult Holometabola.

5. The eighth and ninth somites are the genital segments, which bear the gonopods. The median gonopore of the female is located typically behind the eighth sternum, that of the male behind the ninth. Deviations from these positions are secondary; but the opening of the paired oviducts of Ephemera between the seventh and eighth abdominal sterna probably represents a primitive condition, exhibited also by the embryos of certain insects (see Heymons, 1892, and Wheeler, 1893).

6. The abdominal appendages of adult and larval insects are serially homologous with the legs and mouth parts. Each consists of a *basis*, and of one or two movable appendicular processes. The basis appears to comprise the coxal and subcoxal regions of a typical appendage, the two parts being either distinct or united. The coxal part often

bears an eversible or retractile sac having various functions, represented by the vesiculae of *Thysanura*, the gill-bearing lobes of certain neuropterous larvae, and the plantar lobes of caterpillars and sawfly larvae. The basis of an abdominal limb usually takes the form of a lobe or plate of the body wall, and in the pregenital segments the limb bases are generally united with the sterna in adult insects. The appendicular process of the basis more commonly present is the *stylus* of the lower insects, or its derivatives, including the clasper-like organs borne by the male gonopods of the higher insects. The other limb process is the *gonapophysis*, which occurs only on the gonopods. Both the styli and the gonapophyses may be movable by muscles arising within the supporting basal lobes or plates, or on segmental areas derived from the latter.

7. No positive evidence can be adduced from the known facts of anatomy or embryology to establish the homology of either the stylus or the gonapophysis. Many structural interrelations, however, suggest that the stylus is the telopodite of the appendage, and that the gonapophysis is an endite process of the basis.

8. The genital appendages, or *gonopods*, have the same essential structure as the appendages of the pregenital segments. Their distinguishing feature is the presence of the gonapophyses arising mesally from the bases. In the female, the gonapophyses of the two pairs of gonopods form the first and second pairs of *valvulae* of the ovipositor; in the male the gonapophyses of the ninth segment become the *parameres*. The styli of the gonopods are usually suppressed in the female of pterygote insects; those of the ninth segment of the male form the movable claspers, or *harpes*, of the copulatory apparatus in the Endopterygota.

9. The bases of the gonopods in adult female insects become plates supporting the first and second valvulae; those of the second genital segment may form a third pair of valvulae. In the male the bases of the single pair of gonopods often form distinct pleural plates of the ninth segmental wall between the tergum and the sternum, or they may fuse with either the tergum or the sternum, or with both; again they may unite with each other to form a plate either coalesced with the sternum or free and independently movable behind the latter.

10. The parameres of the male are associated with the median *penis* in the lower insects, generally uniting with the latter except in *Thysanura*; but the penis may be suppressed, and the parameres then unite with each other and inclose the terminal part of the ejaculatory duct to form the more complex copulatory organ known as the *aedeagus*. The parameres are to be identified throughout the

orders by the muscles inserted on them, which take their origins in the supporting basal plates.

11. The styli of the male gonopods become the movable claspers known as the *harpes* in the copulatory apparatus of holometabolous insects. They are to be identified by their muscles which arise in the supporting basal plates. The *harpes* may be divided each into a pair of movable claspers.

12. Numerous accessory appendicular lobes and processes may be developed on all parts of the male genital segment and on segments associated with it. These organs are secondary and are not necessarily homologous in the several orders; they are often flexible at their bases, but are to be distinguished from the true *harpes* and from the *parameres*, with which they are associated, by their lack of muscles.

13. The postpedes, present in holometabolous larvae of several orders, are the pygopods, or appendages of the tenth somite. The postpedes are probably transformed into the appendicular processes of adult males known as *socii*, found in adult Trichoptera and Lepidoptera, or into the cercus-like appendages of adult chalcid-like Hymenoptera.

14. The cerci are the uropods, or the appendages of the eleventh somite. Typically each is situated in a membranous area laterad of the base of the epiproct, and above the paraproct. Muscles that move the cercus arise on the tenth tergum, or also on the epiproct, but these muscles are not necessarily primitive muscles of the cercal appendages. There is no intrinsic evidence that the cerci have any genetic relation with the paraprocts. It is doubtful if true cerci occur in any holometabolous insects, except possibly in females of Mecoptera.

It will be evident from statements given above, and more flagrantly apparent in discussion to follow, that the writer still gives much importance to the value of muscles as determinants of skeletal homologies—and this in the face of the edict against such practices recently put forth by H. J. Hansen (1930). However, there surely can be no question that in studying the insect skeleton we are dealing with the passive elements of mechanisms, in which the active parts are the muscles. The principal sclerotic areas of the body segments, and of the limb segments, are always directly or indirectly associated with muscle attachments or with mechanical strains resulting from muscle actions, and there is every reason for believing that sclerites have been correlated with muscles in their evolution, if not necessarily in their origin. It is, of course, true that, just as some sclerites are secondary productions, so undoubtedly are some muscles. We must admit that all kinds of deviations from a rule are possible; but a few

exceptions do not discredit evidence supported by a long series of uniform interrelations between muscles and skeletal parts. However, a mere discussion of the matter is useless, and in a final analysis the identities of muscles must be established by a study of the muscle innervation. But, in the meantime, practical results may serve as a basis of judgment. The results of the studies to be given in the following pages will appear principally in Part II of this paper, which will attempt to analyze the organs of oviposition, and especially the male organs of copulation, according to the light thrown on the homologies of their parts by an examination of their musculature. The muscles furnish a means as yet but little used for identifying corresponding structures in the male genital apparatus of the various orders, and it will be found that they at least give something definite as a working basis in a comparative study of the genitalia.

For most of the identified material on which the present paper is based the writer is indebted to specialists in the United States National Museum, including the entomologists of the Bureau of Entomology, Department of Agriculture, and Dr. Waldo L. Schmitt and his associates, of the Museum's Division of Marine Invertebrates. Specimens of *Heterojapyx* and *Nesomachilis*, however, were obtained through the interest of Dr. R. J. Tillyard of Australia. Furthermore, much valuable criticism and information has been contributed by Dr. A. G. Böving, Mr. Carl Heinrich, Dr. H. E. Ewing, and other Museum entomologists of the Bureau of Entomology.

I. THE ABDOMINAL SCLEROTIZATION

For purposes of morphological description it is necessary to distinguish *regions* of the body wall from the *sclerites* that may partly or entirely occupy the regional areas. Considering the body as a whole, there are two principal surface regions, one including the back and sides above the limb bases, the other the under surface between the limb bases. The first is the *dorsum* (fig. 1 A, D); the second is the *venter* (V). Then, in a metameric animal, each somite is likewise divided into a *segmental dorsum* and a *segmental venter*. Separating the dorsum and venter of each segment are the latero-ventral limb bases (LB, LB). The regions of the limb bases may be termed the *pleural areas* of the segments. The free distal part of any limb, movable in a vertical plane on the basis, is the *telopodite* (Tl_{pd}).

* It is now well understood that the hardened areas, or sclerites, of the body wall of insects, as well as of other arthropods, are not "chitinized" or "strongly chitinized" regions, but that they are areas of

the cuticula in which other substances than chitin predominate. It has been shown by Campbell (1929), for example, that the exocuticula of *Periplaneta* contains only about 22 per cent of chitin, while the soft endocuticula contains about 60 per cent; and according to Kunike (1926) the wing covers of a May beetle contain by weight 75 per cent of nonchitinous substances, and those of a grasshopper as much as 80 per cent. The writer, therefore, follows the suggestions of Ferris and Chamberlin (1928) in designating the sclerites as areas of *sclerotization* rather than of "chitinization."

Sclerotization of the body wall usually produces definite plates in the several segmental regions. According to the scheme of nomenclature adopted in this paper, a major segmental plate of the dorsum

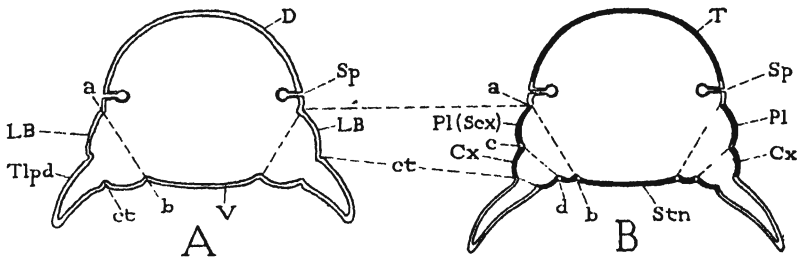

FIG. 1.—Diagrams illustrating the theoretical primitive structure of the appendages and their relation to the body wall.

A, cross section of a segment, showing the basis of each appendage (*LB*) movable antero-posteriorly on the body segment by an axis (*a-b*) in a vertical plane, and the telopodite (*Tlpd*) movable dorso-ventrally at the coxo-trochanteral joint (*ct*).

B, the basis of each appendage subdivided into a subcoxa (*Scox*) and coxa (*Cx*) by a secondary joint with a vertical axis (*c-d*); the upper part of the subcoxa forming the "pleuron" of the body segment.

is a *tergum* (fig. 1 B, *T*), a corresponding plate of the venter is a *sternum* (*Stn*), and a single plate or group of plates in the pleural region is a *pleuron* (*Pl*). Subdivisions or component elements of these principal segmental plates then become *tergites*, *sternites*, and *pleurites*, respectively, since the suffix *ite* grammatically can mean only "a part of" some larger unit designated by the stem of the word to which it is appended.

The plan for distinguishing and naming the segmental regions, the major sclerites, and the subdivisions of major sclerites given above is not generally followed; but the writer has not found any nomenclatural scheme for these parts that is consistently applied, or that adequately meets the situation. Some writers define the terms "terga" and "sterna" as the segmental dorsal and ventral *regions*, and then designate the principal plates of these regions the "tergites" and

"~~Sclerites.~~ sternites." This usage is without other objections than that it leaves us no specific names for the subdivisions or component minor sclerites of major areas of sclerotization. Writers that adopt it seldom follow it consistently. On the other hand, many entomologists find it convenient for descriptive purposes to distinguish the segmental plates of the abdomen from those of the thorax as "tergites" and "sternites." The use of these terms in this manner, however, is not only arbitrary, but it is ungrammatical, since it is clear that the terms ending in *ite* may be applied to metameric units of any particular group of somites *only* if the names "tergum" and "sternum" are defined as the entire dorsum and entire venter of this limited group of somites—a usage which no one pretends to adopt. In general, nomenclatural troubles arise not so much from a scarcity of suitable terms as from a lack of consistent application of words in common use. The writer, therefore, employs the terminology recommended above as the one most adaptable to the needs of anatomical description. And yet, it will be found that absolute consistency is not possible; the insects are sure to present some anatomical conditions that can not be made to fit with any nomenclatural scheme that can be devised. Consistency is said to be a jewel, but an excess of jewelry may become a burden.

Little is known concerning the nature of the sclerotic substances in the cuticula of insects, or of the procedure by which a specific area of the body wall becomes continuously sclerotized. We may believe, however, that minor sclerites may have been produced phylogenetically by the secondary subdivision of major sclerites, though in the ontogeny of the individual they may proceed from separate centers of sclerotization. On the other hand, it is unquestionably true that primarily distinct areas of sclerotization may unite, and give no trace of their independent origin in the development of the embryo or pupa. In the abdomen of most adult insects, for example, the pleural sclerotizations derived from the limb bases are fused with the primitive sterna, and each definitive "sternal" plate in such cases is a triple structure, though it may lose all trace of its composite origin.

The spiracles are important landmarks in the study of the abdominal segments. They never exceed eight pairs in number, and while one or more of the posterior pairs may be absent, the presence of a pair of spiracles is often better proof of the site of a primitive segment than is evidence derived from the sclerites. The primary position of the spiracles is a matter on which opinion differs. There can be no doubt that the spiracles are subject to migration, and that in certain insects they have undergone an extreme displacement; but in the more generalized segments of most insects the spiracles lie in

the sides of the segments above the regions of the limb bases, and therefore in the lateral parts of the dorsum (figs. 1, 2 A, *Sp*). If the tergal sclerotization of a segment does not invade the spiracular areas, the spiracles commonly lie in membranous lower parts of the dorsum between the tergum and the limb bases (fig. 2 A), or between the tergum and the definitive sternum, which has absorbed the limb bases (B). The tergal plates of the abdomen, however, often extend

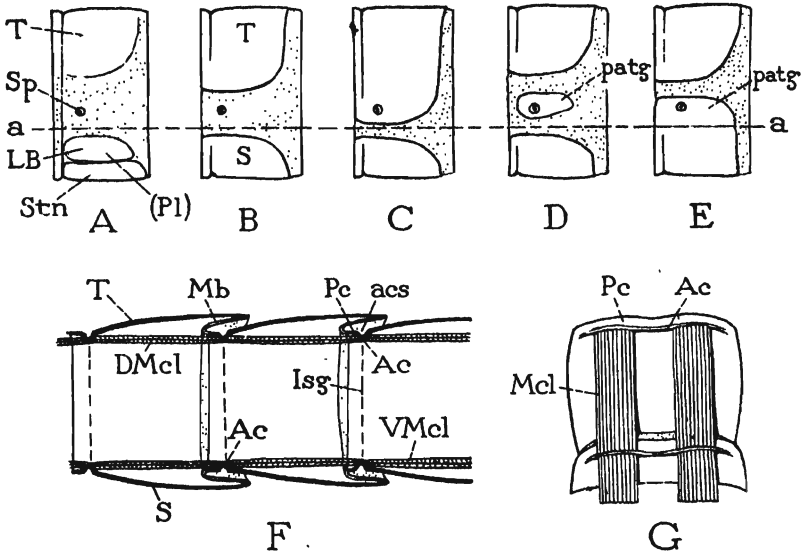

FIG. 2.—Diagrams showing the sclerotization and the retractor mechanism of the abdomen.

A-E, variations of sclerotization above and below the dorso-pleural line (*a-a*) separating the dorsum from the region of the limb bases (*LB*). F, the retractor mechanism as seen in vertical section, resulting from secondary segmentation produced by the usual type of sclerotization in adult insects. G, two consecutive segmental plates and their connecting muscles.

a-a, dorso-pleural fold; *Ac*, antecosta; *acs*, antecostal suture; *DMcl*, dorsal longitudinal muscles; *Isg*, primary intersegmental fold; *LB*, limb basis; *Mb*, secondary intersegmental membrane; *Mcl*, longitudinal muscle; *patg*, paratergite; *Pc*, precosta; *Pl*, pleural plate formed of the limb basis; *S*, definitive sternum including areas of limb bases; *Sp*, spiracle; *Stn*, primary sternal plate; *T*, tergum.

so far downward on the sides of the dorsum as to include the spiracles in their lateral parts (C). In some cases the spiracles occur in independent lateral, or paratergal, sclerites of the dorsum (D). Finally, the definitive ventral sclerotization is sometimes produced upward on the sides of the abdominal segments, and the spiracles may then be included in the lateral parts of the sternal plates (E); but in such cases it is to be suspected that the apparently sternal areas containing

the spiracles are really paratergal sclerotizations that have secondarily united with the sterna.

In the larvae of holometabolous insects there is usually a more or less distinct groove extending along each side of the abdomen below the line of the spiracles (fig. 3 A, B, C, *a-a*), which is continued upon the thoracic region above the regions of the pleural, or subcoxal, sclerites, when the latter are present (B, C, *Scx*₃). This groove, therefore, evidently marks the division between the dorsal and pleural areas of the abdominal segments, and may be termed the *dorso-*

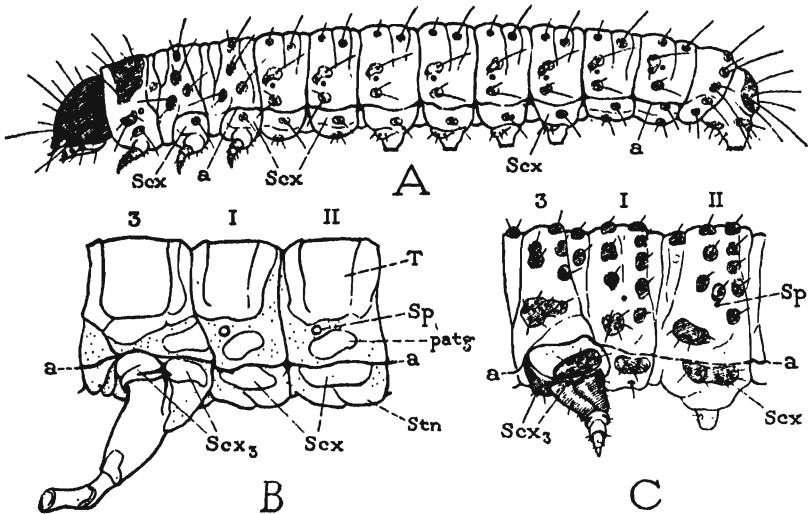

FIG. 3.—External structure of the abdomen in holometabolous larvae.

A, larva of *Carpocapsa pomonella*, showing the dorso-pleural fold (*a-a*) separating the dorsum from the subcoxal areas in both the thorax and the abdomen. B, larva of *Silpha obscura*, with series of paratergal sclerites (*patg*) above dorso-pleural fold, and series of pleural subcoxal sclerites (*Scx*) below fold. C, larva of *Pteronidea ribesii*, showing same structure as in B.

pleural groove. Sclerites or lobes of the body wall lying immediately above this groove, then, belong to the dorsum, and may be called *paratergites* (fig. 3 B, *patg*), but not "pleurites" or "epileurites." Latero-ventral plates or lobes lying below the tergo-pleural groove are properly termed *abdominal pleura* (B, *Scx*) if it is clear by their position or by the presence of appendicular organs upon them that they are the equivalents of the thoracic subcoxal pleura (*Scx*₃). It is convenient, however, to extend the term "pleurites" to any lateral sclerites situated ventrad of the dorso-pleural groove, or below the line of the spiracles, though such sclerites may be evidently secondary sclerotizations of this region (fig. 24 D, *1pl*, *2pl*, etc.). But if there is

reason to believe that lateral sclerites are secondary subdivisions of earlier formed pleurosternal plates, they may be given the non-committal name of *parasternites*. When true pleural plates or lobes of the abdomen are subdivided longitudinally, the upper and lower parts may appropriately be termed *epipleurites* and *hypopleurites*, respectively; but such a division seldom occurs in the abdominal pleura, and the term "epipleurite" is commonly misapplied by students of insect larvae to paratergal lobes, or sclerites of the dorsum.

The fact that the dorso-pleural groove forms a conspicuous line of infolding along the side of the abdomen in many insect larvae (fig. 3, *a-a*) is probably the reason for its frequently having been termed the "pleural suture." Hopkins (1909) thus named it in his study of the larva of *Dendroctonus*, and he designated the lateral lobes above the groove "epipleural" and those below it "hypopleural." The former he believed represented the epimeron of a thoracic pleuron, and the latter the episternum. No such homology as this, however, is possible, since the pleural suture of a thoracic segment is morphologically a vertical groove in the subcoxal sclerotization of the leg bases, taking only secondarily a horizontal position in the metathorax of adult beetles. The so-called "pleural suture" of the larval abdomen, moreover, as we have seen (fig. 3 A, B, C, *a-a*), extends into the thorax *above* the subcoxal sclerotizations (*Scx*), and thus throughout the body separates the dorsum from the true pleural region. Lateral lobes or sclerites of the abdomen lying above the dorso-pleural groove are, therefore, paratergal (fig. 3 B, *patg*), and not "epipleural." Only the so-called "hypopleural" areas lying ventrad of the dorso-pleural groove, that is, between it and the true sternal region, are properly pleural in the sense that they correspond with the subcoxal areas of the thorax (B, *Scx*₃) containing the sclerites of the thoracic pleura. The ventro-lateral lobes or plates of the larval abdomen may, then, be termed the *abdominal pleura* inasmuch as they appear to represent the subcoxae of the thorax. The abdominal pleura are never divided vertically in a way to suggest a true homology with the division of a thoracic pleuron into episternum and epimeron.

The relation of the muscles to the lateral lobes of the abdomen in the larvae of Coleoptera has been studied by Böving (1914) and by Craighead (1916). Böving, here following Hopkins (1909), calls the lateral groove of the abdomen the "pleural suture," but in all his subsequent work he terms it the "ventro-lateral suture." Craighead identifies the lateral areas of the abdomen with the corresponding areas of the thorax in cerambycid larvae, but since he regards the

lateral groove of the abdomen as the "sternopleural suture," he takes the paratergal areas to be the abdominal pleura.

The abdominal terga.—The dorsal sclerotizations of the abdomen in general take the form of simple tergal plates characteristic of any region of the body in which a secondary segmentation has been established. Each tergum presents anteriorly a submarginal or often marginal internal ridge, the *antecosta* (fig. 2 F, G, *Ac*), on which the principal longitudinal muscles usually have their attachments. The *antecostal suture* (F, *acs*) is generally but faintly marked, and the *precosta* (F, G, *Pc*) varies from a scarcely perceptible marginal rim to a wide flange extending a considerable distance anterior to the muscle attachments (G, *Pc*). Apodemal processes are frequently extended from the anterior margins of the terga. From the antecosta of the first abdominal tergum there is commonly developed a pair of phragmatal lobes, and the precostal part of this tergum, together with the antecosta and the phragma, may be separated from the rest of the tergal plate to form a so-called postnotal or postscutellar plate of the metathorax. Otherwise the abdominal terga usually preserve their structural unity. The postcostal areas of the abdominal terga are seldom marked by sutural lines in adult or nymphal insects, and where such lines do occur they can not be supposed to have any homology with the sutures of a wing-bearing thoracic tergum, which adapt the latter to its function in the wing mechanism.

The dorsal regions of the abdominal segments of soft-bodied holometabolous larvae are usually divided transversely by impressed lines or by strongly pronounced topographical features. The dorsal areas thus formed are evidently mere adaptations to the contractile movements of the larvae and have no morphological significance. That the external body features of eruciform and vermiform larvae are secondary larval characters is evident from the structure of the head, which shows that such larvae are lateral derivatives from highly evolved adult forms representing the immediate ancestors of the order.

The abdominal sterna.—The definitive sternal plates of the abdomen are in general similar to the tergal plates, each being a continuously sclerotized area of the ventral integument of its segment, always including the primary intersegmental area anterior to the somite, corresponding with the intersternites, or spinisternites, of the thoracic region. The antecostae may be coincident with the anterior margins of the sternal plates, or set well back from the margins (fig. 2 F, *Ac*) with distinct precostal regions before them. In the Japygidae a short anterior division of each abdominal sternum is separated by a mem-

branous fold from the rest of the plate, forming a distinct *sternal apotome* (fig. 24 D, *Apt*). Apodemal processes to give more effective action to protractor and dilator muscles are commonly developed from the anterior and lateral margins of the abdominal sterna.

Notwithstanding the apparent unity of structure in the abdominal sterna, it is probable, as already stated, that the ventral plates of the pregenital segments in most adult insects are triple structures, each including in its composition the area of the true sternal sclerotization of its segment, and the areas of the limb bases of the corresponding

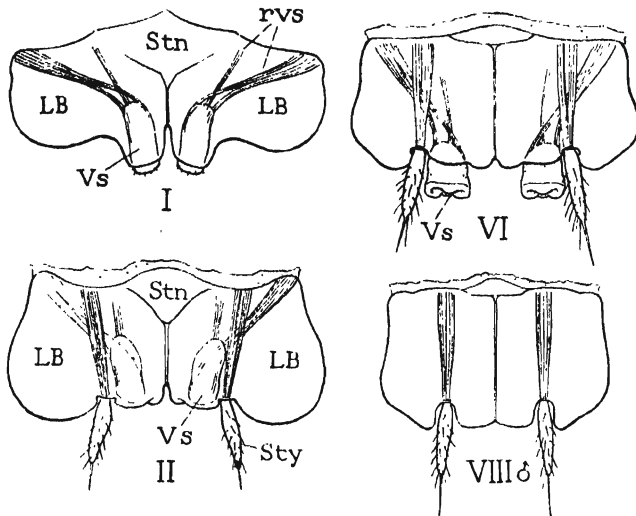

FIG. 4.—Ventral plates of abdomen of *Nesomachilis maoricus*.

I, II, VI, VIII, ventral plates of segments one, two, six, and eight in male. *LB*, limb basis, or basal plate of appendage; *rvs*, muscles of retractile vesicle; *Stn*, primitive sternal sclerite; *Sty*, stylus; *Vs*, eversible and retractile vesicle.

segmental appendages. A comparatively generalized condition is to be seen in larvae of Ephemera, in which lateral lobes of the abdomen supporting the gills (fig. 34 A, B, *LB*), though forming a part of the ventral wall of each segment, are distinct from the areas of the primary sterna (*Stn*), and occupy the primitive position of limb bases on the sides of the segments between the tergal and sternal sclerotizations. A similar but less primitive condition is that occurring in some of the Thysanura, as in the Machilidae (fig. 4), where each of the definitive sterna in the pregenital region of the abdomen consists of a small, median, true sternal sclerite (*Stn*) and of two, large, lateral stylus-bearing plates (*LB*, *LB*) clearly representing the limb bases.

The frequent occurrence of styli on abdominal segments of insects in which the sterna are undivided plates leaves little doubt that the definitive abdominal sterna of insects in general are composite plates including the limb bases as integral parts of their areas. Evidence of the inclusion of the limb bases in the adult abdominal sterna might be derived also from other sources, as in the Lepidoptera, where the abdominal appendages of the larva at the time of pupation are flattened out in the form of discs, and merge into the ventral areas from which later the adult sterna are produced.

A definitive sternal plate that includes the primitive sternum and the bases of the adjacent limbs is sometimes called a "coxosternum," but, as will be shown later, there is a question as to whether the abdominal limb bases represent the coxae or the subcoxae, or include both of these usual basal elements of the appendages. A composite sternal plate, therefore, is more appropriately distinguished from a primitive sternal plate by the term *zygosternum* proposed by Prell (1913). For the same reason the name "coxite," often given to the limb base element of the zygosternum, is objectionable as being more specific in its meaning than is warranted by the known facts of the origin of the part in question. Besides this, the suffix *ite* implies that a structure so-named is "a part of" a coxa, and this implication is clearly not intended.

II. THE ABDOMINAL SEGMENTS

Entomologists sometimes nominally distinguish the segments of the insect abdomen from those of the thorax as "urites," a term perhaps recommended by its brevity, but one which, by inference, reduces the entire abdomen to the status of a "tail." Consistent with this usage, the abdominal appendages would all be "uropods," but the custom of carcinologists in applying the latter term only to the terminal pair of appendages has better anatomical sanction. (Lankester, 1909; Sedgwick, 1909.)

From embryological evidence there appears to be little doubt that the primitive number of abdominal segments in typical insects is at least 12 (fig. 5 A). Twelve segments are actually present in adult Protura (B), each having distinct tergal and sternal plates, but the tenth and eleventh are said to be added by "epigenesis," that is, they are developed during postembryonic growth. In many of the Apterygota and in the lower Pterygota, 11 segments are present without question, while in some forms there are possible rudiments of a twelfth segment. The twelfth or primitive terminal segment is the

periproct (fig. 5 A, *Prpt*), which carries the anus, but does not have appendages. It is the terminal piece of the body anterior to which the true somites are formed, segmentation of arthropods being intrasomatic and not a process of budding. Some investigators claim that a pair of coelomic sacs is formed in the periproct. The presence of not more than six segments in the abdomen of Collembola is usually taken to be the result of reductive specialization, or "degeneration," in these insects, considering that the existence of even six segments is obscure in some forms by a loss of intersegmental lines. Tillyard (1930), however, sees in the Collembola a primitive "protomorphic" condition in which only nine postcephalic somites have ever been developed. He points out that segmentation in the collembolan embryo produces six abdominal segments and no more, and that we have,

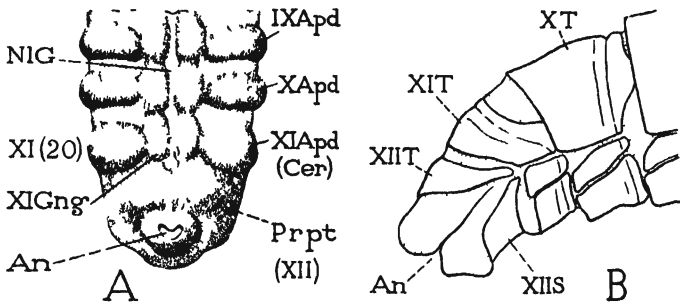

FIG. 5.—Examples of the presence of twelve segments in the hexapod abdomen.

A, posterior end of abdomen of young embryo of *Gryllotalpa* (from Heymons, 1895), with large periproct (*Prpt*), or twelfth segment, behind the last true somite (XI) bearing the cerci (*Cer*). B, end of abdomen of adult proturon, *Acerentulus confinis* (from Berlese, 1910), showing twelve distinct segments.

therefore, no evidence of a greater number of somites ever having been present in this group of arthropods, which he would not ally closely with the other insects. 'A reduction in the number of abdominal segments is the rule in both immature and adult insects generally. As just stated, evident remnants of the periproct are rare except in the Protura. While 11 segments are distinct in many of the more generalized insects, in the higher orders, especially in the Holometabola, not more than 10 segments are usually present, and sometimes only nine are evident. In the more specialized insects there is a tendency toward elimination of the first abdominal segment, but generally reduction takes place at the posterior end of the body. Since the periproct is commonly lacking, or reduced to a circumanal membrane, the eleventh somite, which carries the last pair of segmental appendages, becomes the definitive anal segment. The tenth

segment is sometimes more or less united with the eleventh in orthopteroid insects; but in the Holometabola the eleventh segment is generally suppressed, and the body ends with the tenth segment, though possibly in certain holometabolous larvae the terminal segment contains a remnant of the eleventh somite, while in coleopterous larvae the abdomen ends in a distinct anal lobe, which appears to represent the eleventh segment.

The association of the organs of copulation and oviposition with the eighth and ninth segments of the abdomen is usually accompanied by adaptive structural modifications in these segments that conspicuously differentiate the latter as the *genital segments*, and separate the rest of the abdomen into a pregenital region and a postgenital region. Since the pregenital region contains most of the internal abdominal organs, its segments may be termed the *visceral segments*. The segments beyond the ninth, which are usually more or less reduced and united with each other, constitute the *postgenital segments*. It is not possible, of course, in all cases to divide the abdomen consistently into visceral and genital regions, since modifications adaptive to the major functions of the eighth and ninth segments often affect one or several of the preceding segments, but yet, for general descriptive purposes, the term "genital segments" will have a specific meaning.

THE VISCERAL SEGMENTS

To describe here in full the visceral region of the abdomen would be to repeat many well known facts without adding anything of importance. The seven segments of this region are usually of simple structure and differ but little from one another. In adult pterygote insects they lack appendicular organs, and the definitive sterna probably always include the areas of the primitive limb bases. The first segment is more subject to modifications than are any of the others. In winged insects the antecosta of its tergal plate bears the third pair of phragmata lobes, and the precosta is usually much enlarged, forming the so-called postnotal, or postscutellar, plate of the metathorax (fig. 16, PN_3), which, together with the base of the phragma, is frequently removed from the tergal region of the first abdominal segment and more closely associated with that of the metathorax. The rest of the first segment is often reduced, or fused with the second, and the sternal sclerotization is sometimes obliterated. The first pair of spiracles, however, are nearly always retained, and the spiracles will generally furnish a key to the basal segmentation of the abdomen where the segmental limits are obscured. In the aculeate Hy-

menoptera the entire first abdominal segment is so intimately united with the metathorax that it forms anatomically a part of the thoracic region of the body. Modification of the posterior visceral segments will be noted in connection with a study of the genitalia. In females of higher Diptera the functional visceral region is reduced to five segments by the conversion of the posterior segments into a tubular organ of oviposition.

THE GENITAL SEGMENTS

The lateral ducts of the reproductive organs in the majority of the Hexapoda open into a common, median outlet tube. Exceptions to this rule occur in the males of Protura, in both males and females of Ephemera, and in males of some Dermaptera, the two lateral ducts in these cases opening separately to the exterior. The position of the genital apertures varies within the Hexapoda through an extreme of six segments. In the Collembola the gonopores of both sexes are situated on the fifth abdominal segment, while in the Protura they occur between the eleventh and twelfth segments. In the Ephemera the paired oviducts open between the seventh and eighth abdominal segments, and the vasa deferentia open on the penes between the ninth and the tenth segments. In all other Pterygota, except Dermaptera, and in Thysanura and Dicellura, the single female aperture lies between the eighth and ninth segments, and the male aperture between the ninth and tenth segments. Apparent exceptions to this rule occur where some of the terminal segments are fused, where one or more of the pregenital segments have been obliterated, or where, as in female Lepidoptera, the gonopore has evidently undergone a secondary change in position.

The genital apertures are described by some writers as being situated on the segments, while others state that they occur between segments. The gonopores, in truth, are probably located on the posterior parts of the ventral surfaces of primary segmental areas, but since these parts of the primitive somites become the intersegmental membranes of the definitive segments, the gonopores of adult insects are anatomically intersegmental. They lie behind the primary sterna of the segments on which they are situated, and only rarely is a secondary sclerotization formed behind them (male Odonata). The male gonopore is usually carried outward on an evagination of the body wall forming a simple *penis*, or it is situated on a more complex copulatory organ composed of the *penis* and the parameres, or of the parameres alone, known as the *aedeagus*.

Owing to the uniformity in the relation of the genital apertures to the eighth and ninth abdominal segments, these segments in the majority of insects become specifically the genital segments. Their appendages form the principal organs of egg-laying and copulation, and may therefore be designated *gonopods*. In some of the simpler insects the gonopods are lacking and the genital segments have no distinctive external features; but usually the segments show some conspicuous structural adaptation to the functions of copulation or oviposition.

The eighth segment.—Modifications of the eighth segment (fig. 6, VIII) occur principally in the female, since it is on the ventral part

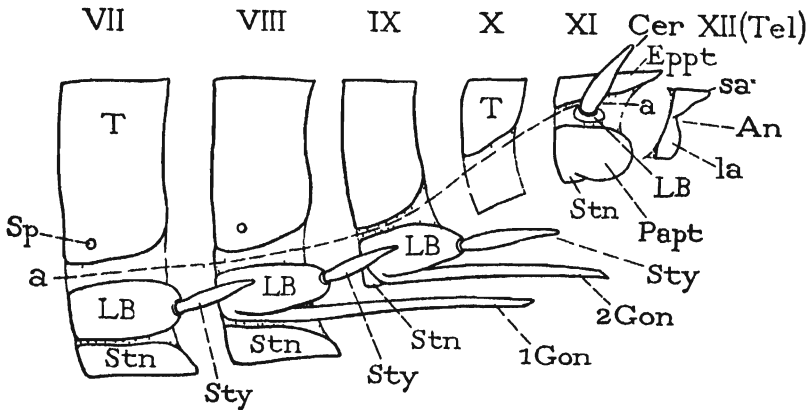

FIG. 6.—Diagram illustrating the concept of the structure of the abdomen adopted in this paper.

a-a, dorso-pleural line separating tergal region from pleuro-sternal region; *Cer*, cercus; *Eppt*, epiproct; *1Gon*, *2Gon*, first and second gonapophyses; *la*, lamina subanalis; *LB*, limb basis; *Papt*, paraproct (lobe of eleventh sternum); *sa*, lamina supra-analis; *Sp*, spiracle; *Stn*, primary sternum; *Sty*, stylus; *T*, tergum; *Tel*, telson (twelfth segment, greatly reduced or obliterated in insects).

of this segment that the first gonapophyses (*1Gon*), or genital processes of the eighth gonopods, are developed, and become the ventral blades, or first valvulae, of the ovipositor in all species provided with an ovipositor. The female genital opening is normally situated between the bases of the first gonapophyses in the membrane behind the primitive eighth sternal plate, but the latter is frequently prolonged beneath the base of the ovipositor, forming the *subgenital plate* of the female. The bases of the gonopods of the eighth segment are never united with the eighth sternum in female insects having an ovipositor. In the Thysanura they are large, stylus-bearing plates or lobes which retain the normal position of limb bases, but in pterygote insects they

appear to form small suspensional sclerites of the first valvulae, known as the valvifers, which always lack styli. Gonapophyses of the eighth segment are known to be present in male insects only in some species of *Machilis*, but the eighth segment of the male is frequently more or less modified when associated with the ninth in the copulatory mechanism.

The ninth segment.—The second genital segment (fig. 6, IX) usually has less of the typical form than does the first. It is the somite of the second gonapophyses (\approx *Gon*), or genital processes of the ninth gonopods, which form the second valvulae of the ovipositor in the female, and the usual parameres in the male. The sternum of the ninth segment is generally reduced or rudimentary in the female, but the bases of the gonopods are commonly retained, either in the form of lobes, or as blade-like pieces of the ovipositor, the third valvulae. In the male the ninth segment retains a generalized structure in the Thysanura (fig. 33, B, C), but in the pterygote insects it is subject to many modifications and takes on a great variety of forms. The bases of the gonopods in male Pterygota either remain as distinct lobes of the segment, or they unite with each other, or with the sternum, or with both the sternum and the tergum. The styli, if retained, usually take the form of movable clasping organs. Various immovable lobes also may be developed from the ninth segment of the male, and sometimes from the eighth, which serve as accessory organs in copulation.

The intromittent organ of the male arises in the Thysanura behind the region of the ninth sternum and between the bases of the gonopods (fig. 33 B, C, *Pen*); but in insects having the gonopod bases united with the sternum, it arises posterior to, or usually above, the limb base area of the composite sternum. The membranous area from which the organ arises is, furthermore, generally more or less inflected between the ninth and tenth segments, forming a *genital chamber* above the ninth sternum, and the ninth sternum is often extended posteriorly as the male subgenital plate, or *hypandrium*. The intromittent organ has the form of a simple, tubular penis in the Thysanura, but in most pterygote insects it is a more complex structure, called the aedeagus, formed of the penis and parameres, or of the parameres alone. The external genitalia will be fully described in Part II of the present paper.

THE POSTGENITAL SEGMENTS

Beyond the second genital segment there are never more than three segments represented in the hexapod abdomen (fig. 6, X, XI, XII),

and it is only in the Protura that the last of these segments is well developed (fig. 5 B, XII). In some of the lower insects apparent traces of the terminal segment are to be found, but in most of the true Insecta there are only two postgenital segments present. A still further reduction, however, has taken place in many insects, with the result that but one segment is to be recognized beyond the ninth. Where two postgenital segments are present there is little doubt that they are the tenth and the eleventh; and where the number of postgenital segments is reduced to one, it is usually to be assumed that the

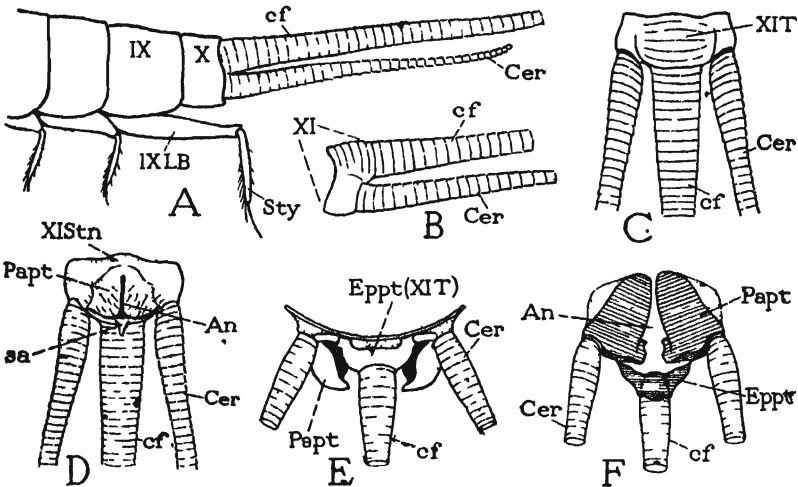

FIG. 7.—Terminal abdominal structures of *Thysanura*.

A, end of abdomen of male *Nesomachilis maoricus*. B, caudal filament and cercus of same removed, showing their origin from small eleventh segment normally retracted into the tenth. C, dorsal view of same. D, ventral view of eleventh segment, with bases of caudal filament and cerci. E, dorsal view of eleventh segment and terminal appendages of *Thermobia*. F, ventral view of same.

An, anus; Cer, cercus; cf, caudal filament; Eppt, epiproct; LB, limb basis; Papt, paraproct; sa, possible rudiment of lamina supra-analis; Stn, primary sternum; Sty, stylus.

single end-segment is the tenth somite, and that the eleventh has disappeared, though it is probable that the tenth and the eleventh somites are in some cases combined in the definitive terminal segment.

✓ *The tenth segment*.—The tenth somite of the abdomen is clearly retained as the numerical tenth segment in insects in which there are two distinct postgenital segments. It is a complete annulus in the Thysanura (fig. 7 A, X), quite distinct from the eleventh segment (B, XI), which is mostly concealed within it. In the Odonata the tenth segment is a continuously sclerotized ring (fig. 12 B, C, X),

beyond which are the parts of the eleventh segment, and apparent remnants of the twelfth (A). Likewise, in larvae of Plecoptera the tenth segment is cylindrical in form (fig. 8 A, X), and the parts of the eleventh segment (*Eppt*, *Papt*) are quite distinct from it. The structure in an adult plecopteran is essentially the same as that of the larva, but the tenth segment is smaller. In the Ephemera, both larval and adult forms, the tenth somite is a well-developed segment, which, because of the reduction of the eleventh somite, forms the terminal segment of the body and appears to carry the long cerci. Its tergal region is produced posteriorly in a median lobe, and thus resembles the supra-anal plate of other insects, but the small true epiproct of the eleventh segment lies beneath the lobe of the tenth tergum and carries the median caudal filament. The venter of the ephemerid tenth segment appears to contain the anal opening, but it is evident that the anus is drawn forward and that the paraprocts are united with the bases of the cerci.

Among orthopteroid insects the tenth segment is variable; its ventral region is usually membranous, and in some families its tergal plate is fused with the eleventh tergum, or epiproct. In the Phasmidae, however, the tenth segment is large and normally developed (fig. 8 E, G, X). In *Diapheromera* it has distinct tergal and sternal plates, the tergum overlapping the edges of the sternum in the female (F), though the two plates are ankylosed in the male to form a strong support for the clasper-like cerci (E). The paraprocts are united ventrally with the tenth sternum (F, *Papt*) and appear to be lobes of the latter. The ventral region of the tenth segment is membranous in most other Orthoptera (fig. 8 D), though the dorsum usually contains a distinct plate (XT). In Acrididae the tenth tergum is a narrow transverse sclerite fused laterally with the ninth tergum, but it is separated from the epiproct by a complete suture. In Blattellidae (fig. 40 A), Tettigoniidae, and Gryllidae (fig. 8 B), however, the tergum of the tenth segment (X), is generally fused with the epiproct (*Eppt*), and since the paraprocts become continuous with the membranous ventral wall of the segment, the tenth somite in these families loses the status of an independent body segment.

It must be noted here that the principal muscles of the cerci arise on the tergum of the tenth segment. The size of the tenth segment, therefore, generally varies according to the size of the cercal muscles, the segment being large in insects having long, mobile cerci (fig. 8 A, XS), and strongly developed in insects in which the cerci have a grasping function, as in *Japyx* (fig. 40 C), and in *Diapheromera* (fig. 8 E, X). When the cercal musculature is weak the tenth segment

is usually reduced, and its tergal plate becomes small, or unites with the epiproct. In certain cases, however, the tenth segment is developed quite independently of any relation to the cerci, as in some of the Homoptera, in which the cerci are rudimentary or absent. In the cicada (fig. 8 C) the tenth tergum is a strong plate produced downward on the sides into a pair of hooked lobes (*l*) embracing the distal end of the aedeagus.

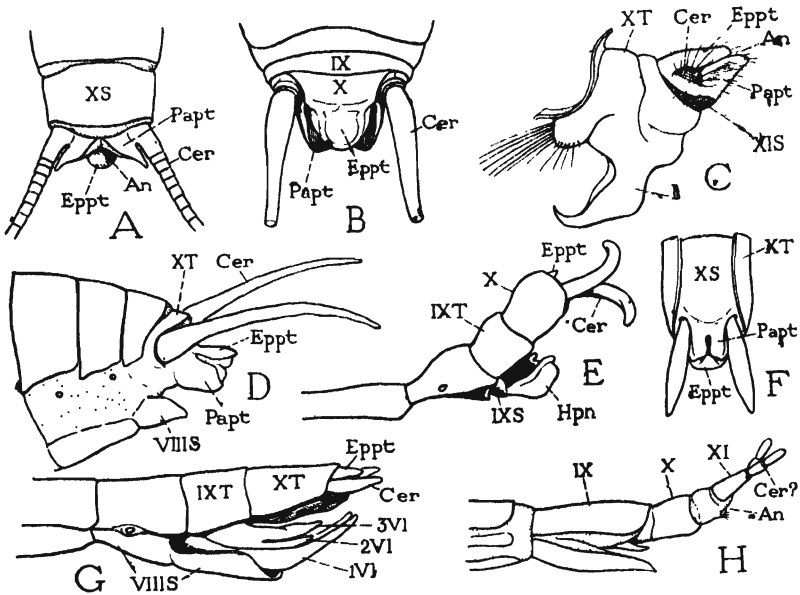

FIG. 8.—Terminal abdominal structures of various insects.

A, larva of plecopteran, ventral view, showing cerci, paraprocts, and epiproct as parts of eleventh segment. B, *Gryllus assimilis*, dorsal view, showing union of epiproct with tenth tergum. C, *Magicicada septendecim*, with eleventh segment distinct from tenth. D, *Scapteriscus didactylus*, female. E, *Diapheromera femorata*, male. F, female of same, showing paraprocts fused with tenth sternum. G, lateral view of genital and postgenital segments of female *Diapheromera femorata*, showing ovipositor, and subgenital plate produced from eighth sternum. H, end of abdomen of female *Panorpa consuetudinis*.

True appendages are absent from the tenth segment in postembryonic stages of all Apterygota and hemimetabolous Pterygota. Rudiments of appendages, however, are well known to be present on the tenth segment of many insect embryos (figs. 5 A, 9 A, X *Apd*). The idea that these appendages are developed in the female into the third pair of valvulae of the ovipositor is now generally regarded as erroneous, since it is clear that both the second and the third pairs of valvulae are parts of the gonopods of the ninth segment. Berlese (1906) records an anomaly found in an adult female of *Locusta*

viridissima, consisting of two pairs of appendicular processes on the tenth abdominal segment closely resembling the two pairs of valvulae on the ninth segment, the outer pair corresponding with the valvulae formed of the basal plates, the inner pair with those formed of the gonapophyses. It is scarcely to be supposed, however, that an abnormality of this kind is a "reversion" to an ancestral normality. The embryonic limb rudiments of the tenth abdominal segment in all the more generalized insects are normally suppressed before hatching. In the Holometabola, on the other hand, appendicular structures frequently occur on the tenth segment in postembryonic stages, and there is little doubt that such organs on the larva, typically represented by the postpedes of caterpillars, are true limb structures; in adults they include the socii of Lepidoptera and Trichoptera, and the cercus-like processes of Tenthredinidae, which appear to be derived from the larval postpedes. The appendages of the tenth, or pygidial, segment of the abdomen may be generally designated the *pygopods*.

The eleventh segment (uro-segment).—The eleventh abdominal segment represents the last true somite of the body, and is present in the embryos of many insects as a well-developed ring bearing the rudiments of the terminal pair of appendages (fig. 5 A, *Cer*). The segment is present in adult Protura as a fully formed annulus with tergal and sternal plates (B, XI), and in some of the lower Insecta having 11 distinct segments in the abdomen the eleventh segment is retained likewise as a complete annulus. This condition is well shown in *Nesomachilis* (fig. 7 B) where the eleventh segment, though mostly concealed within the tenth (A), consists of continuous tergal and sternal regions (C, D), and bears laterally the long, filamentous cerci (*Cer*). The tergal region is produced into the median caudal filament (*cf*), and the sternal bridge supports a pair of broad subanal lobes, the paraprocts (D, *Papt*), separated by a median cleft. In *Thermobia* the eleventh segment has a distinct tergal plate, or *epiproct* (E, F, *Eppt*), but the sternal bridge is lost, and the sternal region of the segment is represented only by the paraprocts (F, *Papt*), upon which are borne the cerci (*Cer*). The median ventral region of the eleventh segment is generally obliterated in pterygote insects that have a well-developed tenth segment, but in some of the Homoptera, as in the cicada (fig. 8 C), the venter of the eleventh segment is not only present but it contains a distinct sclerotic sternal remnant (XIS).

The adult abdomen of most of the lower Pterygota ends with a supra-anal plate (fig. 6, *Eppt*) which is in every way suggestive that it corresponds with the epiproct, or tergum of the eleventh segment, in the Thysanura. Some entomologists, however, basing their opinion on

Heymons' (1895) assertion that the eleventh segment of the embryo in *Grylotalpa* and other Orthoptera is lost during development, regard the supra-anal plate of pterygote insects as belonging to the twelfth segment. On the other hand, Wheeler's (1893) observations on the development of *Xiphidium* are fully convincing that the cercus-bearing eleventh segment persists in the Orthoptera, and, though it becomes reduced, forms the terminal parts of the adult abdomen associated with the cerci. Wheeler's idea that the rudimentary appendages of the tenth segment become the inner valvulae of the ovipositor in the female does not conform with the evident facts of comparative anatomy, but this detail of interpretation does not affect his exposition of the segmentation.

When we compare the usual circumanal structures of pterygote insects with the parts of the eleventh segment in the Odonata (fig. 12 A,

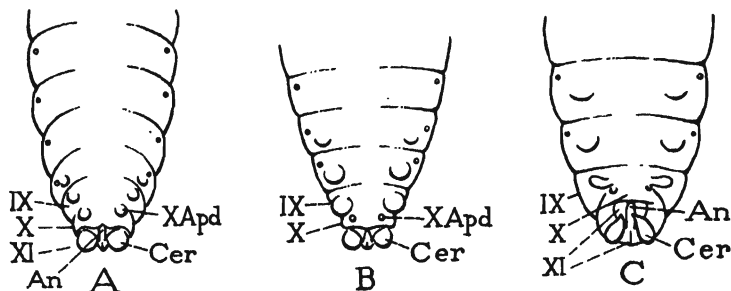

FIG. 9.—Posterior segments and appendage rudiments of embryos of *Xiphidium*. (Outlines from drawings by Wheeler, 1893, showing segmentation and appendages, but with other details omitted.)

A, male embryo. B, female embryo, each with cercal appendages (*Cer*) on eleventh segment. C, female embryo in later stage, showing retention of eleventh segment structures (*XI*).

Eppt, *Cer*, *Papt*), in which Heymons himself has shown that the twelfth segment (*Prpt*) is present though rudimentary, we can scarcely question the identity of the parts in all cases. In other words, the epiproct, the cerci, and the paraprocts, which in larval Odonata clearly belong to the eleventh segment, must be eleventh segment structures in all Pterygota, as they are in Thysanura. Heymons' (1904) claim that the appendages of the eleventh segment in the Odonata are not true cerci, and that the latter are represented in the apparent paraprocts finds no support in comparative anatomy, and has been generally rejected on the ground that it would set the Odonata apart from all other insects.

The writer would, therefore, agree with Crampton (1918) that the epiproct is in all insects the tergum of the eleventh segment (fig. 6,

Eppt), but would dissent from Crampton's opinion that the cerci and paraprocts pertain to the tenth segment, since in such forms as *Nesomachilis* (fig. 7 B) they clearly belong to the eleventh segment, and embryologists agree that the cerci are appendages of the eleventh segment (fig. 5 A). That the paraprocts at least belong to the same segment as the epiproct is evident from their usual anatomical relations with the latter. Ford (1923), in her review of the musculature of orthopteroid insects, says, "from the musculature we find that the supra-anal plate and paraprocts form a symmetrical group," and further she observes that "the transverse muscles between the supra-anal plate and paraprocts show that all three belong to the same segment." The segment represented by the epiproct and paraprocts Ford believes is the twelfth, but she bases her opinion largely on Heymons' statement that the eleventh segment is suppressed in the adult.

Furthermore, the anatomical relations between the paraprocts and the cerci do not support Crampton's (1920, 1921) contention that the paraprocts are the bases of the cercal appendages. The cerci may be united with the paraprocts (figs. 7 F, 8 A), but generally they arise independently in membranous areas behind the tenth tergum between the epiproct and paraprocts. The cerci never have muscles arising in the paraprocts, and the ventral musculature of the paraprocts indicates that these plates are merely lobes of the eleventh sternum (fig. 6, *Papt*), as they are actually in *Nesomachilis* (fig. 7 D). With the usual suppression of the eleventh sternal area, however, the paraprocts may appear to arise from the posterior margin of the tenth sternum, and they are sometimes continuous with the latter (fig. 8 F, *Papt*).

The cerci, as shown by their development, are the *entire* appendages of the eleventh segment. Their primitive bases may be represented by a small, ring-like segment at the root of each organ (Heymons, 1896, Walker, 1922), and, as noted above, they are sometimes united with the sternal paraprocts, but the muscles of the cerci always have a tergal origin. As already observed, most of the cercal muscles arise on the tergum of the tenth segment. These anterior muscles of the cerci, however, appear to be derived from the intersegmental, longitudinal muscle fibers primitively extending between the tenth and eleventh terga, which have secondarily become motors of the cerci. In some Orthoptera, each cercus has a single muscle arising on the epiproct.

The terminal structure of the generalized insect abdomen has a certain resemblance to that of a malacostracan crustacean (fig. 10 A). The twentieth body segment of the crustacean represents the eleventh

segment of the insect abdomen, and its appendages, the uropods (*20Apd*), evidently correspond with the cerci. The telson (*Tel*) being suppressed in insects, the tergum of the eleventh abdominal segment (twentieth somite) becomes the supra-anal plate, or epiproct. The cerci, therefore, may be regarded as the *uropods* of insects.

The twelfth segment.—Among adult Hexapoda a twelfth segment of the abdomen is developed as a complete annulus with tergal and sternal plates only in Protura (fig. 5 B, *XII*). In the arthropods generally the terminal segment is the periproct, or end piece of the body containing the anus, anterior to which the true appendage-bearing somites are formed. In the malacostracan Crustacea the periproct

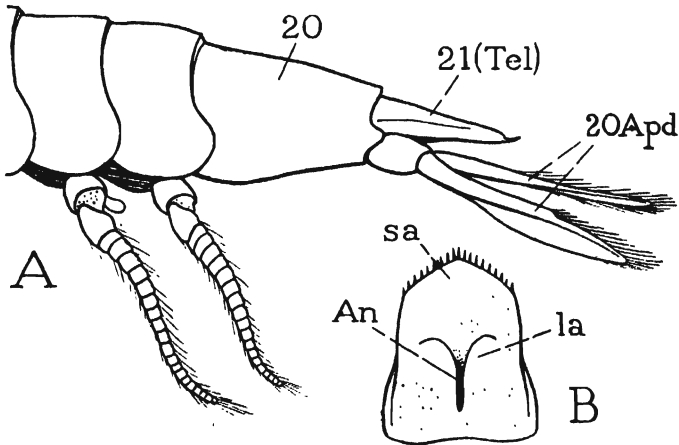

FIG. 10.—Terminal abdominal structures of a crustacean, *Anaspides tasmaniac*

A, posterior part of abdomen, showing the uropods (*20Apd*) as terminal appendages of penultimate segment. B, ventral view of telson, showing lamina supra-analis (*sa*) and laminae sub-anales (*la*) surrounding anus (*An*).

forms the telson (fig. 10 A, *Tel*), typically a broad terminal lobe of the abdomen, having the anus situated in the basal part of its ventral surface (B, *An*) between two lateral valve-like flaps (*la*). A distinct, anus-bearing, terminal lobe of the body is said to be present in the embryos of some insects (fig. 5 A, *Prpt*), but in adult insects there is never more than a vestige of the periproct, or rudiment of a segment beyond the cercus-bearing eleventh somite (fig. 6, *XII*).

The best example of the retention of a twelfth segment in insects is furnished by the larvae of some Odonata, in which the anus is contained in a small circular fold (fig. 12 A, *Prpt*) ordinarily concealed between the bases of the epiproct (*Eppt*) and the paraprocts (*Papt*). In the walls of this circumanal fold, as Heymons (1904) has shown,

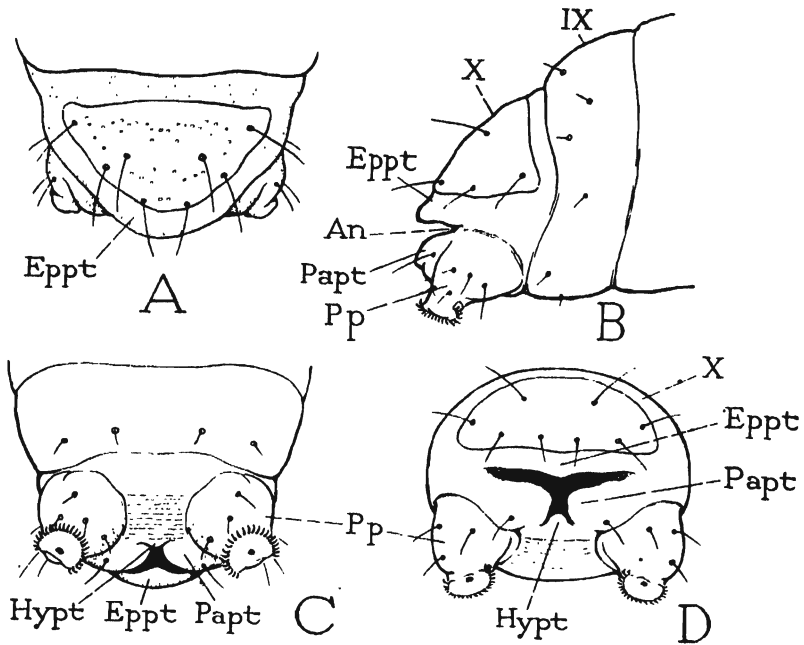

FIG. 11.—Posterior segments of a noctuid caterpillar.

A, dorsal view. B, lateral. C, ventral. D, posterior.

An, anus; Eppt, epiproct; Hyppt, hypoproct; Papt, paraproct; Pp, postpedes (pygopods).

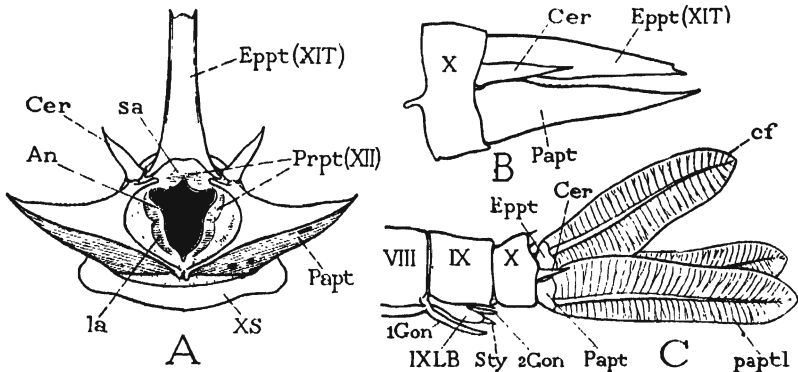

FIG. 12.—Terminal abdominal structures of odonate larvae.

A, aeschnid larva, posterior view of end of abdomen, with epiproct and paraprocts spread out, exposing the periproct (*Prpt*) containing lamina supra-analis (*sa*) and laminae sub-anales (*la*) surrounding the anus (*An*). B, lateral view of same with parts in normal position. C, end of abdomen of larva of *Archilestes grandis*, showing gill plates formed of caudal filament (*cf*) of epiproct (*Eppt*), and of lobes (*paptl*) of paraprocts (*Papt*).

there is a small dorsal sclerite, or *lamina supra-analis* (*sa*), and two lateroventral sclerites, or *laminae infra-anales* (*la*). These sclerites are lost in adult Odonata, but a small supra-anal lobe, possibly a remnant of the lamina supra-analis, projects from beneath the epiproct. A similar lobe occurs in *Nesomachilis* (fig. 7 D, *sa*), as well as in some other Thysanura, and in larvae of Ephemera. The supra-anal lobe of these insects might be regarded, therefore, as a dorsal remnant of the telson (fig. 6, *Tel*). In most insects, however, no trace of a twelfth segment is to be found, and the periproct must be supposed to have been reduced to the membranous area at the end of the eleventh segment in which the anus is situated.

III. THE ABDOMINAL MUSCULATURE

We do not have as yet a sufficient knowledge of the comparative myology of Arthropoda to furnish a basis for any theory as to the nature of the primitive body musculature in this group of animals, in which mobility of the body is a characteristic feature. Widely different patterns of muscle arrangement are encountered in the several arthropod classes, and even within a single class, while, among the insects, extraordinary differences occur often between larval and adult stages of the same species.

In the Insecta the abdominal musculature consists typically of dorsal and ventral longitudinal fibers, dorsal and ventral transverse fibers, and lateral dorsoventral fibers; but in none of these muscle groups do all the fibers often retain their characteristic positions.

The development of the body muscles has been described by Cholodkowsky (1891), Heymons (1895), and Nelson (1915). The dorsal and lateral muscles are formed from the lateral somatic plates of the mesoderm; the ventral muscles arise from the median ventral parts of the mesoderm where the somatic and splanchnic layers are united. The muscle rudiments, or anlagen, according to Heymons, in insects having open coelomic sacs (Blattidae, *Gryllus*, Acrididae), are formed from sac-like evaginations of the mesodermal walls of the segmental cavities, which are at first tubular, but sooner or later become solid strands of cells. In the higher insects, however, in which the coelomic sacs are small or but little developed, the muscles either are formed by the proliferation of cells from the mesoderm segments, or they arise directly from mesenchyme tissue at points corresponding with the position of the coelomic sacs of lower insects.

Since the muscles are derived from the walls of the embryonic coelomic sacs, or from the metameric divisions of the mesoderm, we

may assume that the primitive somatic fibers were all *intra-segmental* in arrangement, as they are in the Annelida. With the acquisition of secondary segmentation in arthropods, however, consequent upon the development of sclerotic plates in the body wall, the principal longitudinal fibers became functionally *intersegmental* (fig. 2 F). The body of the animal can thus be shortened by a telescoping of its segments brought about by contraction of the longitudinal muscles, and it can be compressed by contraction of the lateral dorsoventral muscles. In most cases the opposite movements result either from the elasticity of the body wall, or from pressure generated by contraction in one part of the body transmitted to another through the medium of the body liquid and the visceral organs; but in many insects a dilator apparatus is developed in which certain muscles in both the longitudinal and dorsoventral systems become antagonistic to the retractors and compressors.

The abdominal musculature of adult insects is simpler than the thoracic musculature because of the absence of leg muscles. There is no evidence that the definitive lateral muscles of the abdomen have been derived from the body muscles of the limbs. Muscles of the movable parts of the abdominal appendages, as will be shown in the next section, arise generally within areas of the body wall that may be attributed to the limb bases (figs. 32 B, C, 34 B, 36 D), except the muscles of eversible or retractile sacs which in some cases have evidently extended to the dorsum. The general segmental plan of the abdominal musculature is usually repeated with only minor variations in each of the visceral segments; in the genital and postgenital segments it is more or less obscured by special modifications.

A rather simple scheme of abdominal muscle arrangement prevails throughout all adult pterygote insects; but in the Apterygota and in larval forms of holometabolous insects the musculature may be highly complex. Some students regard the complex types of musculature as representative of a primitive condition from which the simpler types have been derived by elimination. There are reasons, however, for taking the opposite view, as will later be shown.

Something is known of the abdominal musculature in most of the principal orders of insects; but the Odonata, Orthoptera, Coleoptera, Hymenoptera, and the larvae of Lepidoptera and Diptera have received special attention. Trichoptera and Neuroptera, on the other hand, have been particularly neglected, and little has been done on the abdominal musculature of Hemiptera, and of adult Lepidoptera

and Diptera. The following literature contains the principal descriptions of the abdominal muscles of the various orders of insects known to the writer.

PROTURA: Berlese (1910). COLLEMBOLA: Lubbock (1873). THYSANURA: Grassi (1887), giving the characteristics of the abdominal musculature of *Campodea*, *Japyx*, *Machilis*, and *Lepisma*. ODONATA: Wallengren (1914), Whedon (1919), Ford (1923), Steiner (1929), with descriptions of muscles of first three segments in adult by Backhoff (1910) and Schmidt (1915), figures showing larval musculature by Calvert (1911, 1915), and a tabulation of the muscles by Tillyard (1917). EPHEMERIDA: Dürken (1907). ORTHOPTERA: *Gryllus*, Voss (1905), DuPorte (1920); *Dixippus*, first three abdominal segments, Jeziorski (1918); general comparative study of abdominal muscles of orthopteroid insects, Ford (1923). HEMIPTERA: *Aphis fabae*, Weber (1928). ANO-PLEURA: *Haematopinus suis*, Florence (1921). COLEOPTERA: *Melolontha*, Straus-Dürckheim (1828); *Hydrophilus*, first three abdominal segments, Berlese (1909); *Dytiscus*, Bauer (1910), Speyer (1922), Korschelt (1924); larval musculature of other species, Berlese (1909), Böving (1914), Craighead (1916), Paterson (1930). LEPIDOPTERA: larval musculature, Lyonet (1762), Lubbock (1859), Berlese (1909), Forbes (1914, 1916). HYMENOPTERA: larval muscles of a chalcid, Tiegs (1922), of the honeybee, Nelson (1924); adult musculature of pregenital segments of *Vespa*, Berlese (1909), of *Apis*, Carlet (1890), Betts (1923), Snodgrass (1925); full account of abdominal musculature of *Apis*, Morison (1927). DIPTERA: larval musculature partly or briefly described or figured in Syrphidae, Künckel d'Herculais (1875), in *Chironomus*, Miall and Hammond (1900), in *Anopheles*, Imms (1908), in *Musca*, Hewitt (1910, 1914), in *Rhagoletis*, Snodgrass (1924); full account of larval muscles of *Psychoda*, Dirkes (1928), of Culicidae, Samt-leben (1929).

Less appears to have been done on the body musculature of other Arthropoda than on that of insects. Descriptions of the abdominal muscles of Crustacea will be found in the paper on the musculature of *Astacus fluviatilis* by Schmidt (1915), in that on *Pandalus danae* by Berkeley (1928), and in that on *Copilia dana* by Riestler (1931). A paper by Becker (1926) describes the dorsal body musculature of Chilopoda.

GENERAL PLAN OF THE ABDOMINAL MUSCULATURE

A review of the literature cited above gives a fairly comprehensive survey of the abdominal musculature of insects in most of the principal orders. There are notable blanks, however, since such important orders as Neuroptera and Trichoptera are omitted entirely, and adult Lepidoptera and Diptera have been given scant attention. On the other hand it is gratifying to find that we have, as a basis for a comparative study of insect myology, very full accounts of the body musculature of the Odonata, Ephemera, and Orthoptera. In the Apterygota, we are indebted to Berlese for an excellent study of the muscles in Protura, to Lubbock for a description of the collembolan musculature, and to Grassi for brief descriptions of the characteristic differences in the musculature of representative genera of Dicellura and Thysanura, to which is added in this paper an account of the abdominal muscles of *Heterojapyx*; but a more complete study of the musculature of Machilidae and Lepismatidae, and perhaps of *Campodea*, is still to be desired. When we look to the papers treating of holometabolous larvae, we find again satisfactory and in some cases complete accounts of the body musculature in Coleoptera, Lepidoptera, Hymenoptera, and Diptera, but note with regret a lack of information on Neuroptera and Trichoptera.

To present here even a summary of the details known concerning the abdominal muscles of insects would occupy an unwarranted amount of space. A careful review of the facts to be obtained from the works above listed, however, shows that we may with confidence make certain broad generalizations concerning the fundamental plan of the abdominal musculature of adult pterygote insects. The basic plan is found to be simple; but, as so often occurs in insect morphology, more difficulties are encountered in finding suitable terms to express the facts than in discovering the facts themselves.

Voss (1905) classified the abdominal muscles as *longitudinal muscles*, *transverse muscles*, and *lateral muscles* (Flankenmuskeln). This classification is logical inasmuch as it probably conforms with the primitive arrangement of the fibers. The muscles of the so-called longitudinal groups, however, do not always preserve a lengthwise arrangement; they are often strongly oblique, and some of them frequently take a transverse position. The lateral muscles are designated "dorsoventral" muscles by many writers, but, though their attachments are usually dorsal and ventral, some of their fibers commonly run in an oblique direction. The lateral muscles have also been termed "transverse" muscles, but, as Samtleben (1929) points

out, only the crosswise dorsal and ventral muscles are literally transverse in position. Again, the body muscles are sometimes classed as *dorsal*, *ventral*, and *lateral* muscles, the dorsals and ventrals comprising longitudinal, oblique, and transverse fibers, and the laterals including dorsoventral and oblique fibers. This classification is evidently the most nearly consistent one that can be devised, and it has the added merit of being in conformity with the embryonic development of the muscles. Unfortunately, however, in naming the secondary muscle groups or individual muscles according to it, the plan brings out such terms as "median longitudinal dorsal muscles," "external median longitudinal dorsal muscles," or "second internal median

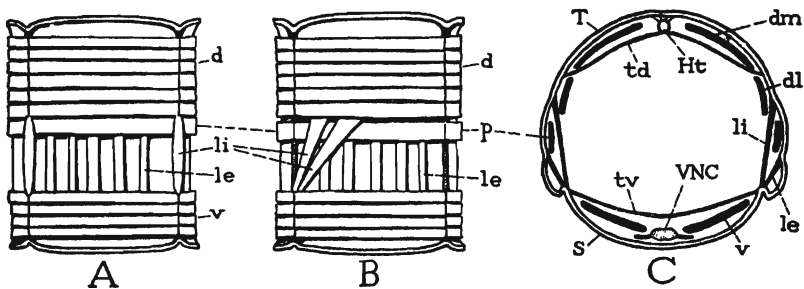

FIG. 13.—Diagrams of the more simple types of segmental musculature.

A, simple condition of musculature in right half of a segment, with dorsal (*d*) and ventral (*v*) fibers attached intersegmentally, external laterals (*le*) intrasegmentally, and internal laterals (*li*) on intersegmental folds.

B, upper ends of internal lateral muscles (*li*) migrated posteriorly, separating a paratergal muscle band (*p*) from the rest of the dorsal muscles (*d*).

C, cross section of segment, showing relations of principal groups of muscles. *dl*, lateral dorsal muscles; *dm*, median dorsals; *le*, external laterals; *li*, internal laterals; *p*, paratergal muscle; *td*, dorsal transverse muscles; *tv*, ventral transverse muscles; *v*, ventrals.

longitudinal dorsal muscle." Still more unwieldy do such terms become when put into Latin form.

It is evident that strict anatomical and nomenclatural consistency in dealing with the body musculature leads to impractical results. The writer, therefore, has adopted a classification and nomenclature that recognizes the anatomical arrangement of the muscles, but which, in order to shorten the names, errs somewhat on the side of specificity in terminology. Five principal groups of muscles are distinguished and designated as follows: I. DORSAL MUSCLES (fig. 13 A, *d*), the fibers of which are typically longitudinal and primarily intersegmental in their attachments. II. VENTRAL MUSCLES (*v*), resembling the dorsals in that their fibers are typically longitudinal and attached primarily on the intersegmental lines. III. LATERAL MUSCLES (*l*),

typically dorso-ventral, their fibers both intersegmental and intrasegmental. IV. TRANSVERSE MUSCLES (*C, t*), lying internal to the longitudinals, including *dorsal transverse muscles (td)*, and *ventral transverse muscles (tv)*. V. SPIRACULAR MUSCLES (*s*), generally not more than two connected with each spiracle, one an *occludor (os)*, the other a *dilator (dls)*.

All the body muscles are bilateral in their origin, and all of them except the ventral transverse muscles remain so in the definitive state. The fibers of the ventral transverse muscles, which primarily are intersegmental, Heymons (1895) says are at first attached mesally on a fold of the body wall between the nerve cords. Later the fold is suppressed and the fibers from opposite sides become continuous across the sternal region. The fibers of the longitudinal dorsal and ventral muscles are always separated into symmetrical lateral groups along the midline of the dorsum and venter, but the lateral sets of dorsal transverse muscles come together on the ventral wall of the heart.

Each primary group of muscles may undergo an endless diversification resulting both from a multiplication of fibers in the group, and from a rearrangement of the fibers brought about by changes in the points of attachment. With respect to the dorsal and ventral muscles, the most general departure from the simple plan, in which the fibers all lie in a single plane, consists of a differentiation of the fibers in each group into *internal muscles* and *external muscles*. Thus it is found in nearly all insects that the dorsal and ventral muscles comprise each two layers of fibers, namely, *internal dorsals (di)* and *external dorsals (de)*, and *internal ventrals (vi)* and *external ventrals (ve)*. A second form of diversification affecting the dorsal and ventral muscles is a more or less distinct grouping of the fibers into median and lateral muscles. In most insects, therefore, we may distinguish four sets of dorsal fibers, and correspondingly four sets of ventral fibers. The several resulting muscles may then be distinguished as *median and lateral internal dorsals* (fig. 14 A, B, *dim, dil*), *median and lateral external dorsals (dem, del)*, *median and lateral internal ventrals (vim, vil)*, and *median and lateral external ventrals (vem, vel)*.

The lateral muscles are more subject to irregularities than are the dorsal and ventral muscles, but they likewise are often divided into *internal laterals* (fig. 13 B, C, *li*) and *external laterals (le)*.

Associated with the dorsoventral lateral muscles there is sometimes present a longitudinal muscle or group of longitudinal fibers lying external to the upper ends of the internal laterals (fig. 13, *p*). This muscle is called the "epipleural" muscle by Ford (1923), but since

it occurs on the region of the dorsum, being situated above the line of the spiracles, and therefore not on the true pleural region, the writer would term it the *paratergal muscle* (*p*). Since this muscle belongs to the dorsum it should be classed as a dorsal muscle.

The fibers of the transverse muscles are never differentiated into distinct layers, but they may be variously grouped in both the dorsal system (fig. 13 C, *td*) and the ventral (*tv*).

The spiracular muscles comprise usually not more than two muscles associated with each spiracle. One is an occluder of the spiracle, the other a dilator. The occluder is seldom lacking; the dilator is less constant.

To express more concisely the principal groups of abdominal muscles and their subdivisions, we may tabulate the muscles in the following manner:

- I. MUSCULI DORSALES (*d*).
 1. M. dorsales interni (*di*).
 - a. M. dorsales interni mediales (*din*).
 - b. M. dorsales interni laterales (*dil*).
 2. M. dorsales externi (*de*).
 - a. M. dorsales externi mediales (*dem*).
 - b. M. dorsales externi laterales (*dcl*).
 3. M. paratergales (*p*).
- II. MUSCULI VENTRALES (*v*).
 1. M. ventrales interni (*vi*).
 - a. M. ventrales interni mediales (*vim*).
 - b. M. ventrales interni laterales (*vil*).
 2. M. ventrales externi (*ve*).
 - a. M. ventrales externi mediales (*vem*).
 - b. M. ventrales externi laterales (*vcl*).
- III. MUSCULI LATERALES (*l*).
 1. M. laterales interni (*li*).
 2. M. laterales externi (*le*).
- IV. MUSCULI TRANSVERSALES (*t*).
 1. M. transversales dorsales (*td*).
 2. M. transversales ventrales (*tv*).
- V. MUSCULI SPIRACULORUM (*s*).
 1. M. occlusores spiraculorum (*os*).
 2. M. dilatores spiraculorum (*dls*).

Each secondary group of muscles is often again subdivided into several bundles of fibers. These ultimate individual muscles may be given numerical designations, beginning medially in the case of the longitudinal muscles and anteriorly with the lateral muscles. Thus

the individual muscles of the median internal dorsals may be specifically indicated *1dim*, *2dim*, *3dim*, etc., the external laterals *1le*, *2le*, *3le*, etc., and the muscles of the other groups in like manner (fig. 15 A). If it is desired to show that a muscle belongs to a particular segment, this may be expressed by adding to its symbol a Roman numeral designating the number of the segment, thus *1dimII*, *3vimIV*, *2leVI*, etc. In describing the complete musculature of a species, however, the writer has found it more practical to number the muscles with Arabic numerals, rather than to attempt to follow any system of lettering that pretends to identify homologous muscles in consecutive segments.

The dorsal muscles.—The muscles of the dorsum are primarily composed of longitudinal fibers of segmental length attached on the intersegmental folds; in many larvae the principal dorsal fibers retain this primitive condition. Wherever the dorsum, however, contains fully-developed sclerotic terga, a secondary segmentation is established, and the folds on which the dorsal muscles are attached become the antecostae of the definitive tergal plates (fig. 14 C, *Ac*). The longitudinal, primitively intrasegmental muscles thus become functionally intersegmental, and serve to contract the abdomen in a lengthwise direction by retracting each tergum into the posterior end of the segment preceding, as far as the intersegmental membrane will allow. The anterior end of a longitudinal abdominal muscle, therefore, may be termed the *origin*, and the posterior end its *insertion*.

The differentiation of the dorsal fibers into internal and external muscles is the rule in both adult and larval stages of pterygote insects. The internal dorsals commonly retain their longitudinal positions, their segmental lengths, and their attachments on the antecostae; but there are many departures from this generalized condition. Frequently the fibers take an oblique position, and sometimes they become shorter than segmental length by a migration of their origins to the postcostal area of the tergum, or of their insertions to the precostal area. The external dorsals seldom retain a segmental length; typically they are short muscles lying in the posterior parts of the segments (fig. 14 C, *de*), and often they become strongly oblique, sometimes actually transverse, giving a movement of torsion between the two segments they connect. Finally, the external dorsals may become completely reversed in position (D, *de*), their origins being so far back on each tergum that they lie posterior to the points of insertion on the anterior edge of the precostal rim of the following tergum. In such cases, the external dorsals become antagonistic to the internal

dorsals (*di*), and function as abdominal *protractors*, since their contraction lengthens the abdomen by decreasing the overlap of the segments.

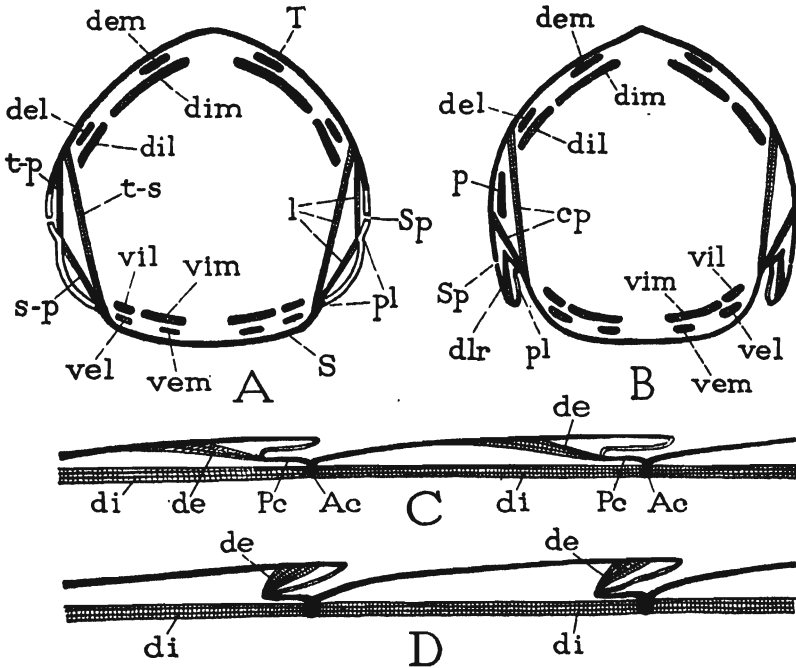

FIG. 14.—Diagrams illustrating more evolved types of musculature, and segmental mechanisms.

A, dorsal muscles differentiated into internal and external median dorsals (*dim*, *dem*), and internal and external lateral dorsals (*dil*, *del*); lateral muscles (*l*) differentiated into tergo-sternal (*t-s*), tergo-pleural (*t-p*), and sterno-pleural (*s-p*) groups; ventral muscles differentiated into internal and external median ventrals (*vim*, *vem*), and into internal and external lateral ventrals (*vil*, *vel*).

B, illustrating the compressor and dilator mechanism of an abdominal segment, in which some of the lateral muscles function as compressors (*cp*), and others, attached ventrally on edge of tergum, become dilators (*dlr*).

C, usual arrangement of dorsal muscles as seen in longitudinal section, with internal dorsals (*di*) attached intersegmentally on antecostae (*Ac*), and external dorsals (*de*) arising on posterior parts of terga, both sets acting as retractors of the terga.

D, modification by which external dorsals (*de*), attached in posterior folds of terga, become antagonistic to internal dorsals (*di*) and act as protractors of the terga.

The division of the dorsal muscles into median and lateral groups of fibers affects both the inner and the outer layers (fig. 14 A, B, *dim*, *dil*, and *dem*, *del*), but it is not always apparent, and the lateral dorsals are sometimes absent. The line of division of the inner dorsals into

median and lateral muscles is sometimes marked by the points of origin of the dorsal transverse muscles on the tergal wall (figs. 13 C, 15 B, *td*).

The paratergal muscle of the dorsum (figs. 13 B, C, 14 B, *p*) is not commonly present in adult insects, or, at least, its fibers are not generally separated from those of the other lateral dorsal muscles. It is well developed in the Acrididae (fig. 15 B, 169), where it is represented in each of the pregenital segments but the first (fig. 16) by a band of intertergal fibers lying above the line of the spiracles external to the upper ends of the internal lateral muscles (fig. 15 B, 175, 176). According to Ford (1923) it is also present in the Plecoptera ("epipleural muscle"). The paratergal muscle occurs more commonly in larval insects. In the abdomen of the larva of *Dytiscus* it is represented by a lateral band of fibers (fig. 18, *p*) cut off from the other dorsal muscles (*dil*, *diii*) by the upper ends of the internal lateral muscles (*lii*). An apparently corresponding muscle, consisting of a pair of parallel fibers extending lengthwise on each side of the body above the line of the spiracles, is characteristic of the caterpillars (figs. 20, 21, *p*). In the larva of *Tipula* there is a broad band of paratergal fibers on each side of the body attached on the middle of the laterodorsal areas of successive segments (fig. 22, *p*).

The ventral muscles.—The ventral abdominal muscles undergo an evolution parallel in most respects with that of the dorsal muscles. Their fibers are nearly always differentiated into internal and external layers, and those of both groups are commonly separated into median and lateral groups. The fibers of the internal layer are typically intersegmental wherever complete sternal plates are developed, and serve as *retractors* of the ventral arcs of the segments. The external ventrals are usually short and take their origins on the posterior parts of the sterna. Frequently they become sternal *protractors* by a reversal of their position, owing to the carrying forward of their points of insertion on apodemal arms of the anterior margins of the sterna until their morphologically posterior ends lie anterior to their points of origin on the preceding sterna. The length of the sternal apodemes commonly gives to the ventral protractor mechanism of the abdomen a greater effectiveness than has that of the dorsum.

The lateral muscles.—It is difficult to make satisfactory generalizations concerning the lateral muscles of the abdomen, because these muscles are subject to more variations in position and attachments than are either the dorsals or the ventrals. Most commonly the lateral muscles are tergo-sternal in their attachments (fig. 13 C, *li*, *le*), and

typically they are vertical in position; but they may comprise tergo-pleural and sterno-pleural fibers (fig. 14 A, *t-p*, *s-p*), as well as tergo-sternal fibers (*t-s*), and generally some of them are oblique. A division of the lateral muscles into *internal laterals* and *external laterals* (fig. 13 B, C, *li*, *le*) is not always apparent, often because of the absence of the internal group, but it is of common occurrence.

The internal lateral muscles, when present, are longer than the external laterals because their upper attachments are at a higher level on the dorsum than are those of the external muscles (figs. 13 C, *li*, 15 B, 175, 176). The position of the internal laterals along the sides of a segment is variable. The muscles are usually situated in the middle or anterior parts of the segments (fig. 16), but in some cases they are limited to the extreme anterior regions, and in certain holometabolous larvae they lie on the intersegmental folds. The internal lateral muscles, however, do not in all cases constitute a homogeneous group of muscles; one or more sets of anterior fibers, such as those forming the first internal lateral muscle of *Dissosteira* (fig. 15 B, 175), lie internal to the lateral tracheal trunk, while the more posterior fibers, as the second internal lateral of *Dissosteira* (176), may lie external to the tracheal trunk. In some insects, on the other hand, the entire series of internal lateral fibers are internal to the lateral tracheal trunk (fig. 22).

An example of the limitation of the internal lateral muscles to the intersegmental regions is well shown in the larva of *Rhagoletis pomonella* (fig. 23), a trypetid fly, in which the muscles consist of slender bands of fibers (*li*) lying laterally on the intersegmental folds in both the abdomen and the thorax. Similar intersegmental muscles, comprising each three groups of fibers, are described by Samtleben (1929) in the larvae of Culicidae as "musculi dorsoventrales mediales," the upper attachments of which are between the ends of the dorsal longitudinal muscles, and the lower attachments between the ends of the ventral muscles. In the larva of *Tipula* (fig. 22) the internal lateral muscles consist of a series of approximately vertical fibers (*li*) occupying the anterior half of the lateral wall of each segment, but the anterior fibers in each segmental group are attached on, or close to, the intersegmental fold. All of these fibers lie internal to the ventrolateral tracheal trunk (*LTr*) and a broad band of longitudinal paratergal fibers (*p*). In the caterpillars a group of several internal lateral fibers (figs. 20, 21, *li*) arise from the lateral extremity of each ventral intersegmental fold and diverge posteriorly to the dorsum, going internal to the lateral tracheal trunk (*Tr*) and the paratergal muscles (*p*).

Similar groups of internal lateral muscles occur in both the abdomen and the thorax of the larva of *Dytiscus*. According to Speyer (1922), a two-branched internal lateral muscle, "musculus dorsoventralis abdominis *a*," occurs in the anterior part of each of the first five segments of the abdomen in the larva of *Dytiscus marginalis* (fig. 18, *liII*). The lower ends of these muscles are inserted on the intersegmental folds, but their upper ends are attached in the anterior parts of the segments following on the tergal plates between median and lateral groups of fibers of the dorsal longitudinal muscles (*di*, *p*). In the thorax, the upper ends of the corresponding muscles (*li*) are more nearly intersegmental; their lower attachments are on the intersegmental "furcillae" and on the sternal apophyses. These muscles of the larval thorax possibly correspond with muscles of the adult described by Bauer (1910), "*musculi levatores prothoracis* and *mesothoracis*," extending from the sternal apophysis of the prothorax and mesothorax to the first and second phragmata, respectively. Similar muscles are sometimes present in the thorax of other adult insects; one such occurs in Acrididae attached ventrally on the prosternal apophysis and dorsally on the intersegmental fold in front of the mesepisternum (see Snodgrass, 1929, figs. 32, 34, 59).

The fragmentary review of the position of the internal lateral muscles given above suggests that the anterior fibers at least of each segmental group represent lateral dorsoventral muscles that are primarily intersegmental (fig. 13 A, *li*). The fibers have a tendency in the abdomen to migrate posteriorly, especially on the dorsum (B), though they may extend backward along the lateral edges of the sternum also (fig. 22). Their upper ends thus cut off a lateral group of fibers (fig. 13 B, *p*) from the longitudinal dorsals, which become the paratergal muscles. These primarily intersegmental internal lateral muscles run mesad to the lateral tracheal trunks in some insects (Acrididae, lepidopterous larvae, tipulid larvae), and their homologues presumably should do so in all insects, but this point has not been determined. Other internal lateral muscles of the abdomen, lying external to the lateral tracheae, are probably intrasegmental in their origin.

The external lateral muscles are typically dorsoventral and intrasegmental (fig. 13 A, B, *le*). Some of them, however, are frequently oblique (fig. 15 B, 178, 179), and the latter may include an intersegmental muscle (fig. 15 A, *4l*). The dorsoventral fibers are sometimes attached on the pleural membrane or on "pleural" sclerites, forming thus tergo-pleural and sterno-pleural muscles (fig. 14 A, *t-p*, *s-p*).

While most of the lateral muscles are *compressors* of the abdomen (fig. 14 B, *cp*), since they serve to approximate the sternum to the tergum in each segment, some of them, at least in insects that make active respiratory movements, serve as *dilators* (*dlr*). The lateral dilators become mechanically antagonistic to the compressors by reason of the fact that their points of origin are on the lower edges of the terga ventral to their insertions on the overlapped edges of the sterna. As in the case of the sternal protractor muscles of the abdomen, the effectiveness of the dilators is commonly increased by the dorsal extension of their points of insertion on apodemes of the sterna.

There is no evidence to suggest that any of the lateral abdominal muscles of adult pterygote insects are derived from the primitive body muscles of the lost appendages. In larval forms that retain appendage rudiments on the abdomen, the lateral muscles lie mesad of the limb bases (figs. 34 A, 36 C, *l*), attached above on the tergum and below on the sternum. The persisting muscles of the abdominal appendages pertain to the distal movable parts of the organs, and these muscles take their origins within the limb bases (figs. 34 A, 36 D). Exceptions to this occur in the case of the muscles of retractile vesicles of holometabolous larvae (fig. 36 C, D, *rvs*), which take their origin on the dorsum, but these muscles are not retained in the adult. The branchial muscles of ephemerid larvae (fig. 15 A, *bmcls*) are said to persist in the adult stage, but they do not appear to correspond with any of the lateral muscles in other pterygote insects.

The transverse muscles.—The transverse muscles of the abdomen are best known as the muscles of the dorsal and ventral diaphragms (fig. 13 C, *td*, *tv*). It seems probable that primitively these muscles were intersegmental in position, their fibers being attached on the intersegmental folds, one set being dorsal, the other ventral.

The fibers of the dorsal transverse muscles arise typically in groups on the anterior edges of the lateral parts of the abdominal terga, and spread mesally to their insertions along the ventral wall of the heart. Only in a few insects are they evenly distributed along the entire length of the tergum, or collected into anterior and posterior groups. The usual anterior origin of the fibers, therefore, suggests that the dorsal transverse muscles are primarily intersegmental. In the caterpillars (fig. 21 A, *td*) they practically have this position, except that the diverging inner ends of the fibers spread into the anterior and posterior parts of the adjoining segments. Usually the muscles of the dorsal diaphragm extend from the second to the eighth or ninth abdominal segment, but in the Blattidae they are said to occur not only in the

first abdominal segment, but also in the mesothorax and the metathorax (Brocher, 1922). In the larvae of anisopterous Odonata, according to Whedon (1919), a muscular dorsal diaphragm is present only in the fourth or the fifth segment of the abdomen.

The ventral transverse muscles in some of the Orthoptera (Tetrigoniidae and most of the Gryllidae) take the form of widely separated compact bundles of fibers crossing the anterior parts of the segmental sterna. In others, as in the Acrididae, the origins of the fibers are distributed along the sides of the sterna, and the muscles form a typical ventral diaphragm occupying most of the length of the abdomen. Ford (1923) thinks that the compact type, that is, the one in which the fibers form individual transverse muscles segmentally arranged, is the primitive type, and that it has been derived from a diffuse or web-like type. The writer, however, believes that the relations may be the reverse, especially considering Heymons' (1895) statement that the transverse muscles of Orthoptera are formed in the embryo along the intersegmental folds. In the larvae of anisopterous Odonata, according to Whedon (1919), there is in the abdomen only a single, large, spindle-shaped, somewhat flattened ventral transverse muscle lying in the extreme anterior part of the sixth segment, attached laterally on the intersegmental fold.

In the higher insects in which ventral transverse muscles are present in the adult, as in Hymenoptera, the muscles form a continuous sheet of tissue over the ventral sinus. Ventral transverse muscles are usually absent in holometabolous larvae. In the honeybee larva, Nelson (1924) says, there is present in the newly hatched larva a well-developed ventral diaphragm consisting of a continuous sheet of transverse fibers, but in older larvae it becomes a vestigial structure formed of more or less isolated fibers entirely too few in numbers to constitute more than a loose and insignificant meshwork.

The spiracular muscles.—The musculature of the abdominal spiracles includes one or two muscles associated with each spiracle. The muscle most generally present is an oclucor. This is a short muscle usually attached at both ends on the base of the spiracular atrium, where its contraction compresses the inner end of the atrium and so closes the entrance to the trachea. In the Acrididae the oclucor muscle arises dorsally on the tergal wall close behind the spiracle. A dilator, or opening muscle of the spiracle, antagonistic to the oclucor, occurs at least in most of the Orthoptera, Lepidoptera, and Hymenoptera, but it is absent in Odonata, some Orthoptera, and Coleoptera. The dilator commonly takes its origin on the tergum or on the lateral margin of the sternum of the segment in which the spiracle is situated.

The musculature of the thoracic spiracles is usually different from that of the abdominal spiracles, as is the structure of the spiracles themselves. The spiracles of Apterygota and Ephemera are said to have no musculature.

THE ABDOMINAL MUSCULATURE OF ADULT PTERYGOTA

The musculature of the visceral segments of the abdomen in pterygote insects adheres closely to the generalized plan of structure, though there are usually slight aberrations in the first segment or first and second segments. The musculature of the genital and post-genital segments is often highly specialized or reduced, but it is undoubtedly derived from the same muscle pattern as that prevailing in the less modified segments. The usual departures from the generalized musculature in the visceral region of the abdomen consist principally of a reduction in the number of muscles, a shortening in the length of some of them, and a shifting of the points of attachment, bringing about simple changes in the position of certain muscles. A brief examination of the orders in which the abdominal musculature is best known will serve to show the extent and nature of the modifications that take place in the visceral segments. The more extensive modifications in the specialized genital and postgenital segments need not concern us here.

Ephemera.—The most generalized abdominal musculature of the adult pterygote type occurs in the Ephemera, and the muscle pattern is here essentially the same in both adult and larval stages. We may, therefore, follow Dürken's account of the larval musculature of *Ephemera ignita*, which can easily be verified in any ephemera species. Most of the abdominal muscles (fig. 15 A), except those inserted on the gill bases (*bmcls*), lie in a single plane against the body wall, and are comprised in dorsal (*d*), lateral (*l*), and ventral (*v*) groups. The first two dorsals (*1d*, *2d*), counting outward from the median line, and the second and third ventrals (*2v*, *3v*) in most of the segments are typical intersegmental, longitudinal muscles attached on the anterior margins of successive segmental plates. The third dorsal (*3d*), however, is atypical in that most of its fibers take their origin on the middle of the tergum and cross the following segment to be inserted on the anterior margin of the second tergum following. This muscle Dürken calls a "compound intersegmental" muscle. The fourth dorsal (*4d*) and the first and fourth ventrals (*1v*, *4v*) are short muscles arising on the posterior parts of the segmental plates before those of their insertions. These muscles thus appear

to correspond with the external dorsal and ventral muscles usually more definitely differentiated from the internal muscles in the majority of the Pterygota.

The true lateral body muscles of *Ephemerella* include only the intrasegmental, vertical, tergo-sternal muscles (fig. 15 A, 1l, 2l, 3l), and the intersegmental, tergo-oblique muscle (4l). The groups of branchial muscles (*bmcls*), inserted in the larva on the bases of the gills, are described and figured by Dürken as arising on the lateral parts of the sterna. The areas on which these muscles

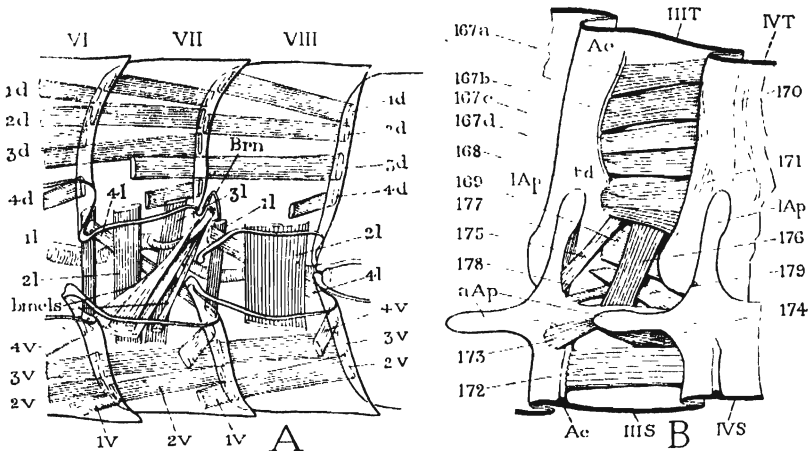

FIG. 15.—Examples of abdominal musculature.

A, musculature of left half of seventh and eighth segments (seen externally) of abdomen of larva of *Ephemerella ignita* (from Dürken, 1907); *bmcls*, branchial muscles, shown here as originating on lateral part of sternum, which is probably the ventral area of limb basis (see fig. 34 B).

B, muscles of right half of third abdominal segment (seen internally) of an acridid, *Dissosteira carolina*. 167, internal median dorsals; 168, internal lateral dorsal; 169, paratergal muscle; 170, external median dorsal; 171, external lateral dorsal; 172, median ventral; 173, internal lateral ventral; 174, external lateral ventral; 175, 176, internal laterals; 177, 178, 179, external laterals; *td*, insertion point of dorsal transverse (cardiac) muscles.

arise, however, are clearly distinct from the true sterna (fig. 34 A, B, *Stn*), and very evidently represent the bases of the abdominal limbs (*LB*), of which the gills (*Brn*) are the distal movable parts. The branchial muscles, therefore, are not body muscles, but are intrinsic muscles of the appendages, and take their origins within the limb bases. The true lateral body muscles (fig. 34 A, *l*) are tergo-sternal in their attachments and lie mesad of the lobes (*LB*, *LB*) supporting the gills. The gill muscles of the ephemerid larva, Dürken says, are retained without change in the adult. They do not appear

to have representatives in the pregenital segments of any other adult pterygote insect.

Odonata.—The muscles of the first three abdominal segments of adult Odonata are described by Backhoff (1910) and by Schmidt (1915) in connection with a study of the male genital organs, and some of the abdominal muscles of odonate larvae are figured by Calvert (1911, 1915). A more complete description of the larval musculature as a part of the respiratory mechanism is given by Wallengren (1914), and of that of the adult by Steiner (1929), while a full account of both the adult and larval muscles in Zygoptera and Anisoptera will be found in the paper by Whedon (1919) on the morphology of the odonate abdomen, a few errors in which are corrected by Steiner (1929).

In the abdominal musculature of the Odonata there is nothing to suggest a type of structure more primitive than that of other Pterygota; the fundamental plan of the muscle arrangement is that of pterygote insects in general, and has little to distinguish it from the muscle pattern of orthopteroid insects. The generalized plan of musculature is best retained in the larvae of Zygoptera. The muscles here comprise internal and external longitudinal dorsals, internal and external longitudinal ventrals, and dorsoventral and oblique lateral muscles. The internal dorsal and ventral fibers are of segmental length; but the externals in each set are short, taking their origins on the posterior parts of the segments. In the Anisoptera the larval muscles are more strongly developed than in the Zygoptera, evidently as an accommodation to the respiratory and locomotor functions of the rectum, and the broad internal dorsal and ventral bands of fibers take on oblique direction. The adult musculature is much reduced in the abdomen, and most of the muscles are very short, but the arrangement of the muscles shows no radical departure from the fundamental pterygote pattern better preserved in the larva.

Orthoptera.—The comparative myology of the abdomen is better known in the Orthoptera than in any other of the larger orders of insects owing to the comprehensive review by Ford (1923) of the abdominal musculature of orthopteroid insects. Then, too, Voss (1905) in his thorough study of the thorax of *Gryllus* includes an account of the muscles of the anterior abdominal segments, and Du Porte (1920) describes the entire musculature of the abdomen in the same genus.

The abdominal musculature of the Orthoptera and related orders shows in all groups a differentiation of the dorsal and ventral muscles

into internal and external layers of fibers, and in most cases a well marked separation between median and lateral fibers in each of these groups. In a general statement on the abdominal musculature of orthopteroid insects, Ford (1923) says: "In the common ancestors of the orthopteroid insects the tergal musculature probably consisted of two broad layers, an internal longitudinal and an external oblique, with the inner layer approximately equaling the length of the tergum, and the outer layer much shorter. Of the present-day orders the Blattaria approach closely this hypothetical type." Of the ventral

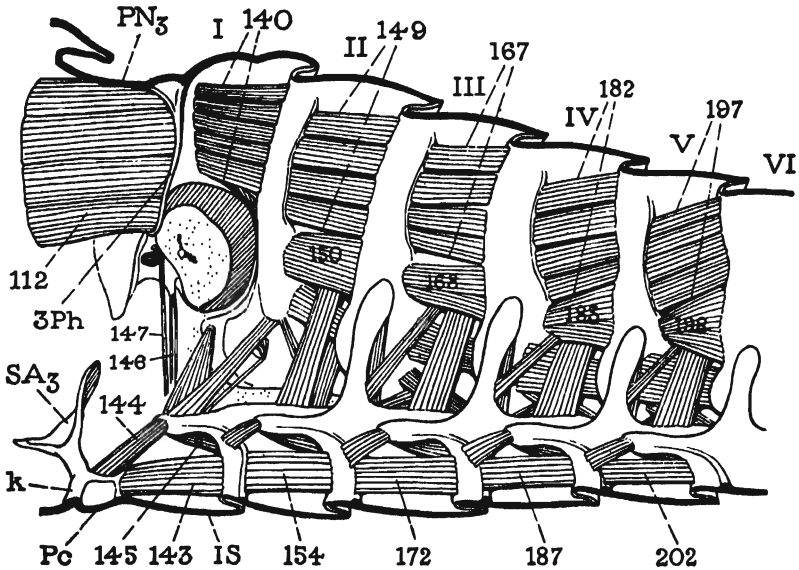

FIG. 16.—Musculature of the right half of the first five segments of the abdomen of *Dissosteira carolinay*, together with dorsal muscles (112) of meta-thorax. (Compare with fig. 15 B.)

140-197, median internal dorsals; 150-198, lateral internal dorsals; 143-202, median ventrals; 144, first lateral internal ventral; 145, first lateral external ventral.

musculature Ford says: "The hypothetical type of sternal musculature is similar to the tergal, having the two-layered arrangement of longitudinal ental and oblique ectal muscles. The Blattaria again resemble the hypothetical type."

Since the external muscles of the dorsum and venter are not always oblique, being often parallel with the internal muscles, and since, furthermore, the dorsal and ventral muscles are not always differentiated into external and internal layers (fig. 15 A), it would seem to the writer more probable that all the dorsal and ventral fibers were

primarily longitudinal and of segmental length, and that they had this arrangement in pre-orthopteroid insects. The internal dorsals and ventrals are likewise often oblique. Obliquity, therefore, would appear to be secondary also in the external muscles, in which it may be so accentuated that the muscles lie in a transverse direction, or are even reversed in position.

The lateral muscles of the Orthoptera are variable in their positions and in their attachments. They include typical vertical and oblique intrasegmental tergo-sternal muscles, oblique intersegmental tergo-sternal muscles, and in some cases muscles that may be termed "tergo-pleural" and "sterno-pleural," since they are inserted on the lateral membranes or on sclerites below the line of the spiracles. The so-called pleural areas on which these last named muscles are attached, however, probably really belong either to the dorsum or to the venter of the segment, and, if so, none of the lateral muscles is properly a "pleural" muscle.

In the Acrididae the internal dorsal muscles are distinctly separated into median and lateral groups of fibers (figs. 15 B, 16, 167, 168) by the points of attachment of the dorsal transverse fibers on the tergum (fig. 15 B, *td*). The external dorsals assume very oblique or transverse positions (170, 171). The ventral muscles are well differentiated into median and lateral groups of internal fibers (172, 173) and into lateral external muscles (174). The external ventrals (174) are sternal protractors by a complete reversal in the relation between their points of attachment. The lateral muscles in the third and succeeding segments (figs. 15 B, 16) comprise two internal dorso-ventral laterals (fig. 15 B, 175, 176), and three external laterals (177, 178, 179), of which the first (177) is an abdominal dilator by reason of its sternal attachment being on the upper end of a large lateral sternal apodeme (*LAp*). The upper ends of the internal laterals (175, 176) are attached on the tergum between the lateral internal dorsals (168) and a broad paratergal dorsal muscle (169). This last muscle is the "epipleural" muscle of Ford (1923), who says a similar muscle also is present in the Plecoptera.

Coleoptera.—The abdominal musculature of adult Coleoptera is known principally from the description of *Melolontha vulgaris* by Straus-Dürckheim (1828), and of *Dytiscus marginalis* by Bauer (1910) and Korschelt (1924).

The adult musculature of the abdomen of *Dytiscus* is relatively simple. As described by Bauer (1910) it consists of dorsal longitudinal muscles, ventral longitudinal muscles, and lateral muscles, to which list should be added the transverse muscles of the dorsal diaphragm.

Bauer terms the lateral muscles "musculi transversales abdominis," but, as pointed out by Samtleben (1929), the lateral muscles are dorsoventral and should not be termed "transverse." The largest muscles of the *Dytiscus* abdomen are the dorsal muscles. These consist of broad bands of fibers forming a wide sheet of muscles against the tergal region in each of the first six segments. The ventral muscles are present only in segments III, IV, and V. They include large median ventrals and small lateral ventrals. The median ventrals form three pairs of muscle sheets occupying the median sternal region of the segments, the fibers of the opposite groups in each pair converging posteriorly. The lateral ventrals ("musculi ventrales externi" of Bauer) are very small, each arising on the posterior lateral angle of the sternum of its segment, and being inserted on the anterior margin of the sternum following. The lateral muscles ("musculi transversales" of Bauer) comprise a pair of small, oblique tergo-sternal muscles crossing each other in the form of an X in each side of segments II to V inclusive, and a single oblique muscle in segment VI.

Hymenoptera.—The honeybee furnishes the principal information that we have on the abdominal musculature of Hymenoptera. The muscles of a typical abdominal segment of the honeybee have been described by Carlet (1890), Betts (1923), and Snodgrass (1925); the complete abdominal musculature is given by Morison (1927). The muscles characteristic of the part of the abdomen involved in respiration are well shown in the third and fourth segments (fig. 17). The dorsal muscles consist of three sets of fibers in each half of the segment, two of which are internal and one external. The internals form a broad median band of fibers (*dim*) slanting from in front posteriorly and medially, and a slenderer lateral muscle (*dil*) extending from in front posteriorly and laterally. The external dorsal is a short muscle (*del*) arising laterally on the posterior margin of the tergum and extending forward to its insertion on the tip of a lateral tergal apodeme of the following segment. The two sets of dorsals are thus antagonistic, the internal fibers being tergal retractors, and the external fibers tergal protractors. The ventral musculature comprises internal and external muscles, which are likewise antagonistic. The internal fibers form an oblique median internal ventral (*vim*) on each side of the sternum, the two converging mesally in the form of a V, and a slenderer lateral muscle (*vil*) oblique in the opposite direction. The external ventrals consist of a single small, fan-shaped lateral muscle on each side (*vel*), arising laterally on the posterior part of the sternum and inserted anteriorly on the lateral anterior apodeme

of the following sternum. The lateral muscles comprise three tergo-sternal muscles in each side of the segment. The first (*1l*) is a dilator of the abdomen, since it arises ventrally on the lateral part of the tergum and is inserted dorsally on the tip of the lateral apodeme of the sternum; the second and third laterals (*2l*, *3l*) are oblique tergo-sternal compressors of the abdomen.

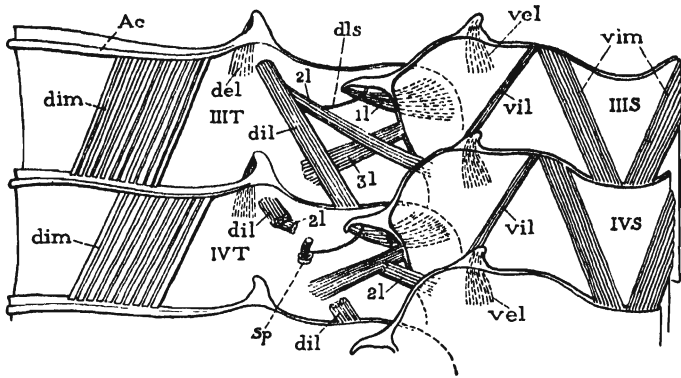

FIG. 17.—Musculature of two consecutive abdominal segments of adult *Apis mellifica*, showing the muscles on the left side.

Ac, antecosta; *del*, lateral external dorsal muscle; *dil*, lateral internal dorsal; *dim*, median internal dorsal; *1l*, *2l*, *3l*, first, second, and third laterals; *dils*, dilator muscle of spiracle; *Sp*, spiracle; *vel*, lateral external ventral muscle; *vim*, lateral internal ventral; *vim*, median internal ventrals.

The first lateral muscles (*1l*) are dilators of the abdomen, the second and third laterals (*2l*, *3l*) are compressors; the internal dorsal and ventral muscles (*dim*, *dil*, *vim*, *vil*) are retractors of the segments, the external dorsals and ventrals (*del*, *vel*) are protractors.

THE ABDOMINAL MUSCULATURE OF ENDOPTERYGOTE LARVAE

The body musculature of endopterygote, or holometabolous, larvae, in its higher forms of development, attains an extreme degree of complexity; in its simpler forms it differs but little from the body musculature typical of all adult Pterygota. It appears, therefore, that the complex types of larval musculature represent specialized conditions adapting the larvae to their individual ways of living, and are not to be interpreted as meaning that insects are derived from ancestral worm-like forms having an intricate body musculature. The changes in the musculature that occur during the pupal metamorphosis are to be regarded as alterations necessitated by the restoration of the normal adult musculature, which involve varying degrees of destruction or reconstruction in the special, temporary larval musculature.

Coleoptera.—The larval musculature of Trichoptera and Neuroptera has not been fully studied, nor do we have any comparative work

on the larval muscles of the Coleoptera. The complete account of the muscles of the *Dytiscus larva* given by Speyer (1922) and by Korschelt (1924), however, furnishes a basis for an understanding of the relation between the larval musculature and the musculature of adult insects. The structural changes which take place in the transformation from the larval to the imaginal musculature have been described by Breed (1903) in a trogotid, *Thymalus marginicollis*.

The abdominal musculature of the larva of *Dytiscus marginalis*, as described by Speyer, consists of four primary groups of fiber bundles, namely, dorsal muscles, ventral muscles, and, on each side, a set of lateral (dorsoventral) muscles. In the region of the first seven abdominal segments, the dorsal muscles comprise an internal set of

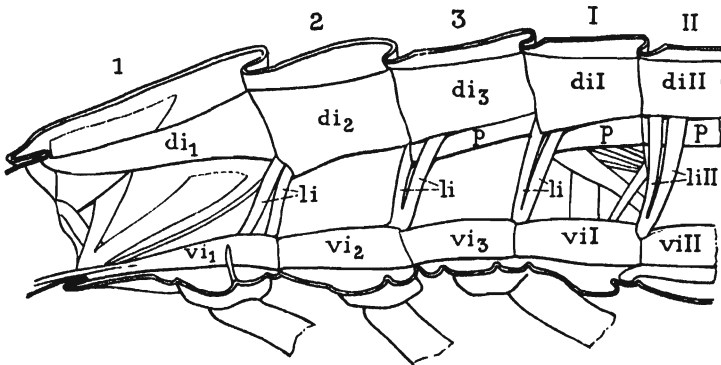

FIG. 18.—Body muscles in right half of thorax and first two abdominal segments of *Dytiscus marginalis* larva. (Outline from figure by Speyer, 1922, re-lettered in accord with muscle nomenclature adopted in this paper.)

di, internal dorsal muscles; *li*, internal lateral muscles, upper ends of which cut off paratergal muscles (*p*) from the other dorsals; *vi*, internal ventrals.

intersegmental longitudinal fibers of segmental length (fig. 18, *diI*, *diII*), and outer sets of short fibers extending from the posterior parts of the terga to the following intersegmental folds. The ventral muscles consist likewise of internal (*viI*, *viII*) and external sets of intersegmental fibers. In each side of the first five abdominal segments Speyer distinguishes six lateral (dorsoventral) muscles. Five of these are external laterals, three of which are tergo-sternal and two tergo-pleural in their attachments. The other lateral muscle is an internal lateral and consists of two bundles of fibers (*liII*), which arise ventrally by a common base on the intersegmental fold. Dorsally the two branches are inserted on the anterior lateral part of the tergum between median and lateral sets of the dorsal longitudinal fibers (*di* and *p*). In the thorax the muscles (*li*) corresponding with

the internal laterals of the abdomen occur between the prothorax and mesothorax, between the mesothorax and metathorax, and between the metathorax and first abdominal segment. They are attached above more nearly on the anterior margins of the terga, and are inserted ventrally on the intersegmental "furcillae" and on the sternal apophyses. The posterior migration of the upper ends of the internal laterals in the metathorax and abdomen cuts off a lateral group of fibers (*p*) from the longitudinal dorsals that evidently corresponds with the paratergal muscle of *Dissosteira* (fig. 15 B, 169).

It is clear that the abdominal musculature of the *Dytiscus* larva differs in no essential respect from that characteristic of adult insects generally. It presents a more primitive condition in that the internal lateral muscles retain ventrally their intersegmental attachments, whereas in most adult insects, when present, their ventral ends have migrated posteriorly along the edges of the sterna (fig. 15 B, 175, 176, fig. 16).

The figure given by Berlese (1909) of the muscles in the first three abdominal segments of the larva of *Pentodon*, and the studies of Böving (1914) and of Craighead (1916) on the abdominal musculature of coleopterous larvae, including species of Cleridae, Trogositidae, Elateridae, and Scarabaeidae, suggest that the chief deviation from the *Dytiscus* larval muscle pattern consists only of a greater diversification in the position of the muscles, and of an increase in the number of muscles or individual fibers in each group. In any case it is clear that the larval musculature in the Coleoptera presents at most but a small increase in complexity beyond the minimum characteristic of adult pterygote insects. Proceeding from this condition found in the Coleoptera, therefore, we may expect to find that the more complex musculature of other holometabolous larvae represents only a more highly specialized condition.

Hymenoptera.—In the larvae of Hymenoptera the body musculature also retains a relative simplicity. The pattern of the abdominal muscles of the honeybee larva (fig. 19), as described by Nelson (1924), departs but little from the basic plan of the general adult pterygote musculature, though it is somewhat more complex than the abdominal musculature of the adult honeybee (fig. 17), and is not at all like the latter in detail. The dorsal muscles of a typical abdominal segment of the larva (fig. 19) consist of broad bands of internal longitudinal fibers (*di*) of segmental length, and of shorter, oblique external fibers (*de*). Some of the external fibers, by a transposition of their posterior attachments on the intersegmental fold, have come

to overlap internally the internal dorsals. The ventral muscles include internal oblique (*vi*) and external oblique muscles (*ve*), all of segmental length. The lateral muscles comprise dorsoventral and oblique external laterals (*le*), and a strong, oblique, internal sterno-tergal muscle (*li*) attached on the consecutive intersegmental folds. It may be questioned whether this last muscle represents the internal laterals of the *Dytiscus* larva (fig. 18, *li*), but the only difference between the two is that the upper end of the muscle in the bee larva is attached on the intersegmental fold following that of its ventral attachment, a change that might have come about by a posterior migration of its dorsal end.

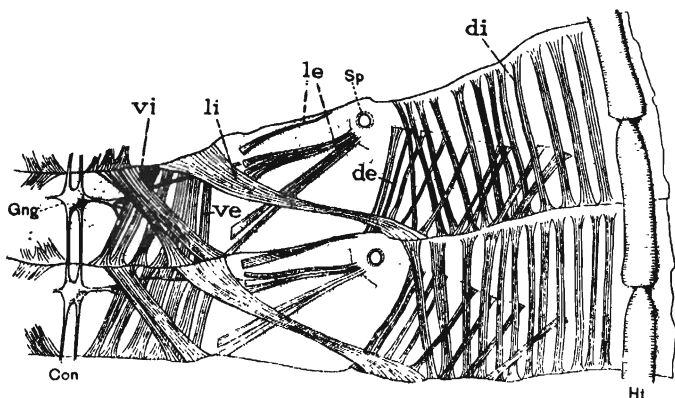

FIG. 19.—Musculature of right half of two consecutive abdominal segments of honeybee larva. (Figure from Nelson, 1924, but relettered in accord with muscle nomenclature adopted in this paper.)

Con, ganglionic connectives; *de*, external dorsal muscles, some of them secondarily internal at posterior ends; *di*, internal dorsals; *Gng*, segmental ganglion; *Ht*, heart; *le*, external lateral muscles; *li*, internal lateral muscle; *Sp*, spiracle; *ve*, external ventral muscles; *vi*, internal ventrals.

Lepidoptera.—The larvae of *Lepidoptera* have long been noted for the great number of muscles that lie against the body wall, and for the extreme complexity in the arrangement of the fibers. Fully 150 muscles, mostly individual fibers, may be counted in a typical abdominal segment of any caterpillar (figs. 20, 21). The principal muscles of the innermost layer (figs. 20, 21 A) are definite bands of parallel longitudinal fibers having segmental lengths and attached on the intersegmental folds. In the ventral region there are also strong external muscles of segmental length having an oblique position. Most of the external fibers, however, are of various lengths and are disposed in all directions against the body wall (fig. 21 B). On each side of the body, between the principal dorsal and ventral groups of muscles

there is a pair of slender, longitudinal paratergal muscles (figs. 20, 21 A, B, *p*) lying just above the line of the spiracles and the lateral tracheal trunks (*Tra*). Anteriorly in each segment the paratergal muscles are crossed internally by a group of internal lateral fibers (*li*) arising ventrally on the intersegmental fold, and diverging dorsally and posteriorly to their attachments on the dorsum. These internal lateral muscles of the caterpillar lie internal to the lateral tracheal trunks. The dorsal transverse muscles of the caterpillar (figs. 20, 21 A, *td*) arise in groups immediately dorsad of the paratergal muscles from the posterior margins of the intersegmental folds.

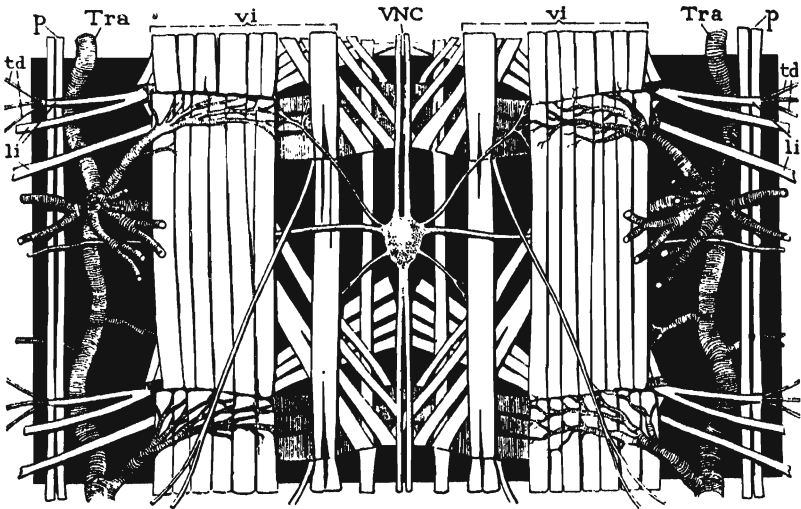

FIG. 20.—Ventral musculature of fourth abdominal segment of a caterpillar, *Estigmene acrea*.

li, internal lateral muscles; *p*, paratergal muscle; *td*, origins of dorsal transverse (cardiac) muscles; *Tra*, lateral tracheal trunk; *vi*, internal ventral muscles; *VNC*, ventral nerve cord.

The complexity of the body musculature of the caterpillar appears to demonstrate that the muscle system of insects has no limits imposed on its possibility of diversification both by multiplication and by rearrangement of its fibers, since there is no reason to believe that the intricate pattern of the caterpillar muscles represents in any way the primitive plan of insect musculature. In the other organization of the lepidopterous larva there is little to suggest a primitive condition. The head and mouth parts present the typical fundamental structure of these organs that has been developed in adult Pterygota, and on this basic structure have been built up the many special features of the

caterpillar head and mouth parts adapted to the needs of the larva. The alimentary canal of the caterpillar is highly specialized in its musculature. The simplicity of the nervous and tracheal systems

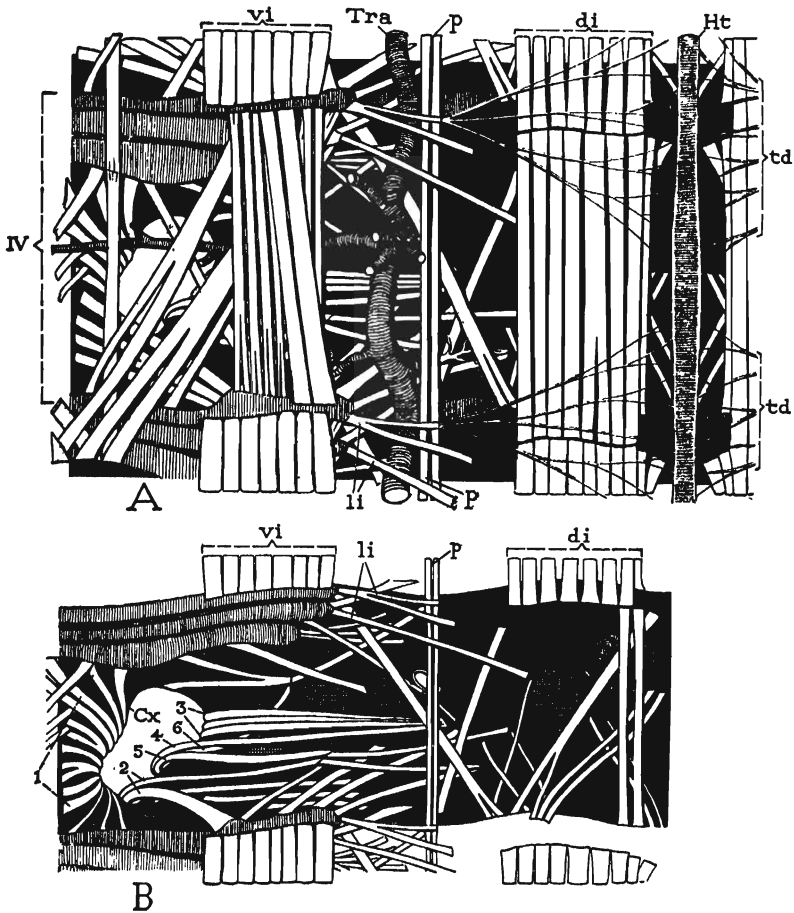

FIG. 21.—Abdominal muscles of a caterpillar, *Estigmene acraea*, seen by removal of inner muscles shown in figure 20.

A, muscles of right half of fourth segment (IV) after removal of internal ventrals (vi). B, outermost muscles in right half of third segment, showing particularly the leg muscles; cross-hatched areas represent bases of hair-bearing tubercles.

Cx, basal rim of leg; di, internal dorsal muscles; Ht, heart; li, internal lateral muscles; p, paratergal muscles; td, dorsal transverse (cardiac) muscles; Tra, lateral tracheal trunk; vi, internal ventral muscles.

is not necessarily an indication of a primitive state; it is merely the retention of a generalized structure in these organs accompanying a high specialization in others. The presence of appendages on the pre-

genital segments of the abdomen likewise signifies nothing more than the retention of organs useful in the larval stage. In short, the worm-like form of the caterpillar and of other holometabolous larvae has no phylogenetic significance. It is a secondary adaptation, derived from the normal adult pterygote structure, accompanied by numerous specializations peculiar to the larva, and later discarded. The complex musculature of the caterpillar is only one of the features in the larval organization that have been specially evolved from the generalized adult structures of the immediate ancestors of the Lepidoptera to enable the caterpillar to perform more efficiently the duties that have devolved upon it from the apportionment of the life processes between the immature and adult stages of the individual.

Diptera.—The musculature of the larvae of Diptera shows a unique type of specialization in its highest development, but at the other extreme it has a pattern corresponding entirely with that of the generalized plan of abdominal musculature in adult Pterygota.

The simpler forms of dipterous larval musculature, known in the Tipulidae, Psychodidae, Chironomidae, Culicidae, and Tabanidae, consist of dorsal and ventral bands of longitudinal fibers, and of lateral dorsoventral muscles. A primitive type of musculature occurs in the Psychodidae, where, as described by Dirkes (1928) for *Psychoda alternata*, the dorsal and ventral muscles are mostly longitudinal and attached on the intersegmental folds, though a few in each set are shorter than segmental length. In the first abdominal segment there are five dorsoventral laterals and two oblique laterals on each side. The first of the dorsoventral muscles is attached on the intersegmental fold between metathorax and abdomen, the others follow along the side of the segment. A similar condition exists in the Culicidae, as described by Samtleben (1929), except that here some of the inner muscles of the dorsal and ventral series in each segment cross obliquely over the outer muscles, and the inner lateral muscles are confined to the anterior parts of the segments, where they are attached on the intersegmental folds between the ends of the dorsal and ventral muscles. In the larva of *Tipula* (fig. 22) the musculature is complicated by a great increase in the number of fibers in all the principal groups, and by a diversification in their points of attachment, but there are few fibers taking an oblique course. In both the dorsal and ventral groups certain sets of fibers are attached regularly on the intrasegmental transverse folds of the body wall, and some of the median ventral fibers form somewhat oblique interlacing bundles. The internal lateral muscles (*li*) comprise a series of dorsoventral fibers

lying in the anterior half of each segment *internal* to the lateral tracheal trunk (*LTra*). Outside of these muscles, and external to the tracheal trunk, is a wide band of longitudinal paratergal fibers (*p*) of

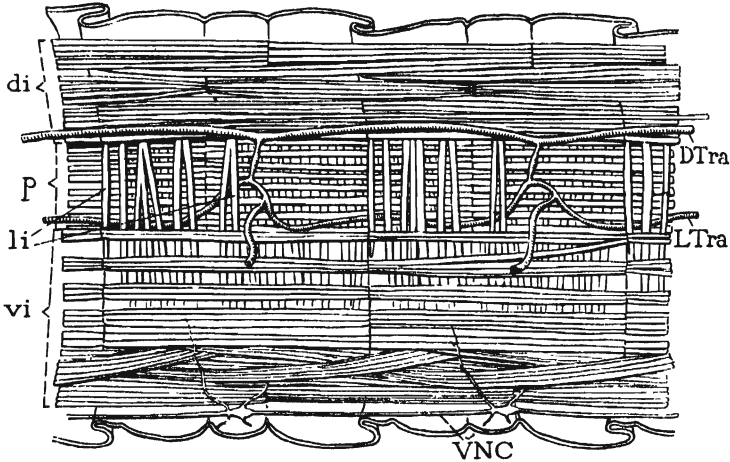

FIG. 22.—Musculature of right half of two consecutive abdominal segments of *Tipula abdominalis* larva.

di, internal dorsal muscles; *li*, internal lateral muscles distributed in anterior half of segment internal to lateral tracheal trunk (*LTr*); *p*, band of paratergal fibers; *vi*, internal ventral muscles.

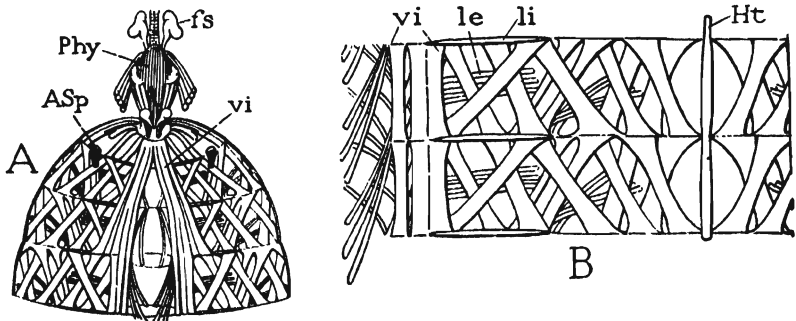

FIG. 23.—Musculature of the body wall of the larva of a cyclorrhaphous dipteran, *Rhagoletis pomonella*.

A, musculature of the thorax and first abdominal segments, seen from above, with pharynx and connected parts turned forward. B, musculature of right half of two consecutive abdominal segments.

ASp, anterior spiracle; *fs*, frontal sacs; *Ht*, heart; *le*, external lateral muscles; *li*, internal lateral muscles; *Phy*, pharynx, turned forward; *vi*, longitudinal bands of internal ventral muscles.

segmental length, but attached on the median intrasegmental folds of the dorsum. The numerous external laterals lie against the body wall external to the paratergal fibers.

In the larvae of the higher Diptera the dorsal and ventral musculature appears to be merged into a double series of oblique muscles regularly crossing one another to form a network pattern repeated throughout the thorax and the abdomen (fig. 23). The only muscles that preserve a longitudinal direction are two bands of ventral fibers continued from the prothorax to the end of the abdomen (*vi*). There can be little doubt that this type of musculature represents a highly specialized condition, correlated with the great specialization which the maggot shows in nearly all other parts of its body organization. The lateral muscles, on the other hand, appear to retain a primitive condition. The internal laterals consist of slender fibers lying on the intersegmental folds (*li*) along the sides of the body. The external laterals (*le*) comprise a small group of fibers in the side of each segment against the body wall external to the network of oblique muscles.

THE ABDOMINAL MUSCULATURE OF APTERYGOTA

The body musculature of apterygote hexapods is not well known in all the major apterygote groups; it has been carefully studied in representatives of Protura, Collembola, and Dicellura, but only casually examined in Thysanura. Particularly desirable, therefore, would be a complete account of the body muscles of Machilidae and Lepismatidae.

Protura.—The abdominal musculature of the Protura is fully described by Berlese (1910) in his monograph on the "Myrientomata." In this group of hexapods, Berlese says, "the musculature is extraordinarily complex by reason of the great multiplicity of fibers extending in all directions, very much as in the larvae of metabolic insects." The muscle pattern of the proturan abdomen as shown by Berlese, however, is not complex by comparison with that of a caterpillar or of a muscoid maggot, and the proturan body muscles clearly fall into the three usual categories of insect muscles, namely, dorsal muscles, ventral muscles, and lateral muscles, to which are to be added the body muscles of the appendages.

The dorsal abdominal muscles of Protura are divided into external dorsals and internal dorsals. The internal dorsals (muscles of the second stratum of Berlese) consist of broad bands of fibers in the Acerentomidae attached on the successive tergal antecostae. In the Eosentomidae they are differentiated into median and lateral groups of fibers. The external dorsals (muscles of the third stratum of Berlese) include two large oblique muscles on each side of each seg-

ment; one (the intersegmental tergal muscle of Berlese) arising medially on the anterior part of the tergum and inserted laterally on the antecosta of the following tergum, the other (the intersegmental tergopleural muscle of Berlese) arising anteriorly on the tergal antecosta and inserted posteriorly on the "pleuron" of the following segment. The so-called "pleuron," however, is probably to be regarded as a paratergal sclerite.

The ventral muscles of the abdomen include likewise external ventrals and internal ventrals. The internal ventrals consist of paired bands of longitudinal fibers extending throughout the length of the abdomen. Each muscle band is divided into a median group of fibers attached on the sternal antecosta of each segment, and into longer lateral muscles in the first five segments attached on alternate sterna. The external ventrals occur only in the first three abdominal segments of Acerentomidae. Those of the first segment extend from the center of the sternum laterally to the bases of the appendages of this segment, and serve as adductors of the appendages. In the second and third segments corresponding pairs of muscles arising on the anterior median part of each sternum diverge posteriorly to the antecosta of the following sternum.

The lateral musculature of the abdomen in Protura has a very simple pattern. The lateral muscles comprise intrasegmental vertical tergo-sternal muscles, and intersegmental oblique tergo-sternal muscles. The intrasegmental laterals include in each of the first three abdominal segments of Eosentomidae, and in the first segment only of Acerentomidae, a pair of tergal muscles inserted ventrally on the base of the appendage, and in the following segments of Acerentomidae a single lateral tergo-sternal muscle. The intersegmental laterals consist of two slender muscles arising laterally at each end of the tergal antecosta in each segment, one of which goes to the anterior margin of the sternum of the preceding segment, the other to a corresponding point on the sternum of the following segment. From the first abdominal tergum a muscle extends downward to the posterior edge of the metathoracic sternum, and another goes forward to the posterior edge of the mesothoracic sternum.

An analysis of the proturan musculature, as described by Berlese, thus shows that the Protura suggest nothing different as to the pattern of the primitive body musculature of the Hexapoda from the idea to be derived from a study of the muscles of adult Pterygota. Since the lateral musculature in the Protura does not match with that of any pterygote insect, it does not appear to be the prototype of the lateral musculature characteristic of the Pterygota, and therefore,

probably represents a special development. The Protura have no transverse muscles. Berlese describes a dorsal septum above the alimentary canal, but, he says, it is composed entirely of a connective tissue membrane and contains no muscle fibers. A closed dorsal vessel is likewise absent.

Collembola.—The account of the body musculature of the Collembola given by Lubbock (1873) is so complete and so convincing in its detail that no doubt can be entertained of its accuracy, though apparently no subsequent investigator has verified it, or given any attention to the musculature, other than that of the appendages, in this interesting group of insects. Lubbock describes the muscles of *Tomocerus* as an example of the musculature of a "linear" species, and those of *Smynturus* to illustrate the musculature of a "globular" species. It is clear that the muscle pattern in the abdomen of the former is more generalized than in that of the latter, but that in both forms the musculature is modified in adaptation to the specialized functions of the abdominal appendages.

The abdominal musculature of *Tomocerus* is highly developed, consisting of strong bands of longitudinal dorsal and ventral muscles differentiated into internal and external groups of fibers, and of vertical and oblique dorsoventral lateral muscles. In the first segment two strong muscles arising on the tergum are inserted on the eversible vesicle of the collophore. In the third segment groups of lateral muscles are attached ventrally on the sternal region in the neighborhood of the tenaculum, but they do not appear necessarily to be primarily muscles of the pair of appendages presumably combined in this organ. The muscles of the furcula, or spring supported on the fifth segment, take their origins in the fourth and third segments, but they appear to be parts of the system of longitudinal body muscles rather than specific muscles of the leaping appendage. In *Smynturus* the abdominal musculature is highly modified. The longitudinal muscles appear to be reduced and are mostly absent in typical form. On the other hand, there is a great development of vertical and oblique dorsoventral muscles associated with the base of the furcula, taking their origins in the posterior and middle parts of the abdomen.

In no respect can the collembolan musculature be said to be primitive; but it is evident that it may be derived from the same generalized plan of muscle arrangement that underlies the abdominal musculature of adult pterygote insects.

Dicellura.—It is most interesting to find in Grassi's description of the muscles of *Campodea* that the pattern of the abdominal musculature of this primitive apterygote insect conforms closely with the

fundamental plan of the abdominal musculature of pterygote insects. According to Grassi, the musculature of an abdominal segment of *Campodea* comprises longitudinal dorsal and ventral muscles, oblique dorsal and ventral muscles, and dorsoventral lateral muscles. The longitudinal muscles are clearly the internal dorsals, and internal ventrals. The oblique dorsal muscles are the external dorsals. The external ventrals are represented by a pair of muscles convergent from the posterior margin of the segment to the mid-sternal region below the ganglion. These muscles Grassi terms *musculi subganglionares*. In addition to these there are also small oblique and transverse lateral ventral muscles. The true lateral muscles include several small tergo-sternal fibers on the sides of each segment. Finally there are the muscles of the styli and eversible vesicles.

By comparison with *Campodea*, or with almost any other insect, the body musculature in the Japygidae is extremely intricate, being highly complicated by the presence of numerous muscles that appear to have no relation to muscles in a simple type of musculature. The following account of the abdominal musculature of a member of this group is based on a study of specimens of the Australian *Heterojapyx gallardi*, for which the writer is indebted to Dr. R. J. Tillyard. Females of this huge japygid reach a length of 40 millimeters, and a dissection of the muscles in well preserved specimens is not a particularly difficult task.

The entire body musculature of *Heterojapyx* anterior to the ninth abdominal segment is highly complex, there being in each of the first eight segments of the abdomen at least 40 pairs of muscles, the arrangement of which makes a most intricate pattern against the body wall (fig. 24). In the mesothorax and metathorax the musculature is quite as complex, and in many details quite different from that of the abdomen, and is more diversified by the presence of the leg muscles. In the ninth abdominal segment the musculature is simplified. In the tenth it consists of a single pair of fiber bundles, but these constitute two great lateral muscles, almost completely occupying the segment, which act as adductors of the cercal forceps.

The 40 muscles in either half of a typical abdominal segment of *Heterojapyx*, shown in figure 24 representing segment VI, are comprised in the following groups:

I. DORSAL MUSCLES.—A median band of *inner longitudinal intersegmental dorsals* (A, 1a, 1b, 1c); two *medio-lateral oblique intersegmental dorsals* (A, B, 2, 3); two *latero-median oblique intersegmental dorsals* (B, 4, 5); and an *outer longitudinal intersegmental dorsal* (B, 6).

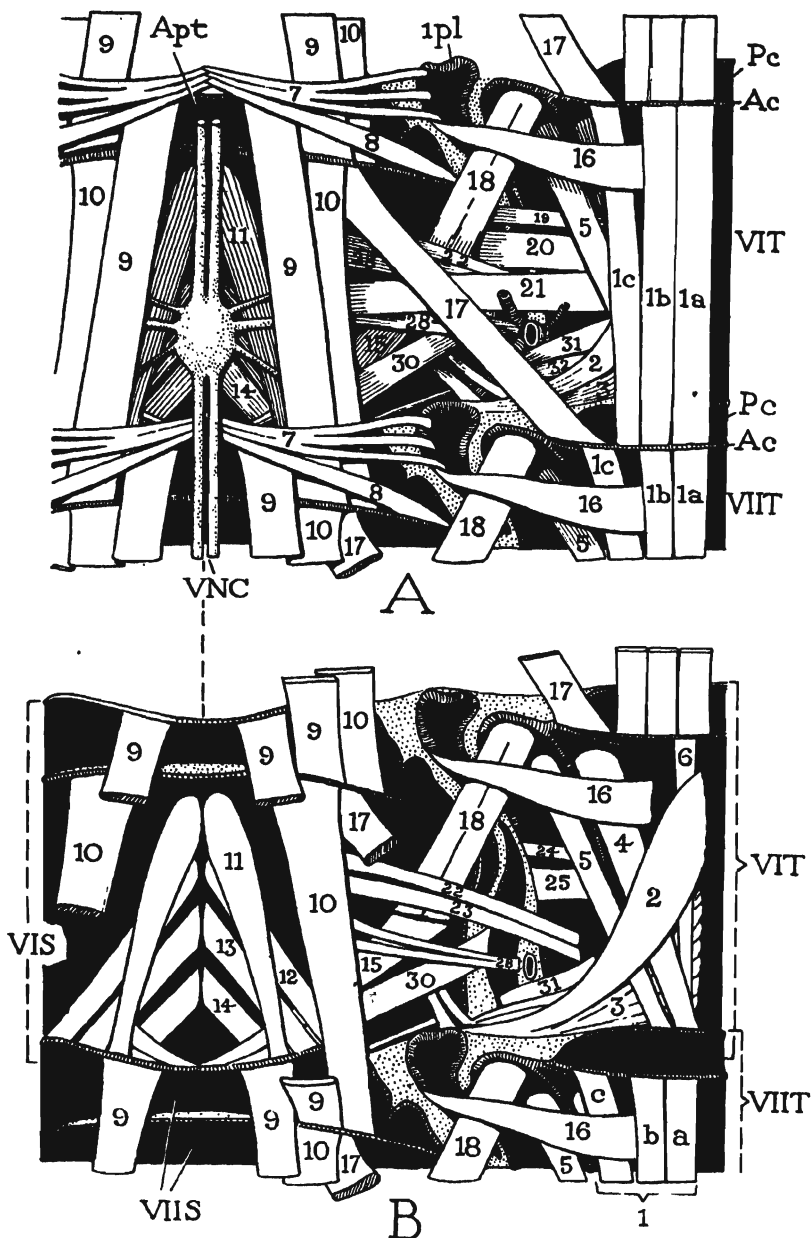

FIG. 24 A, B.—Musculature of sixth abdominal segment of *Heterojapyx gallardi*.

A, muscles of ventral region and right half of sixth segment, and anterior part of seventh segment. B, same view with muscles 7, 8, 9, 17, 19, 20, 21 partly or entirely removed.

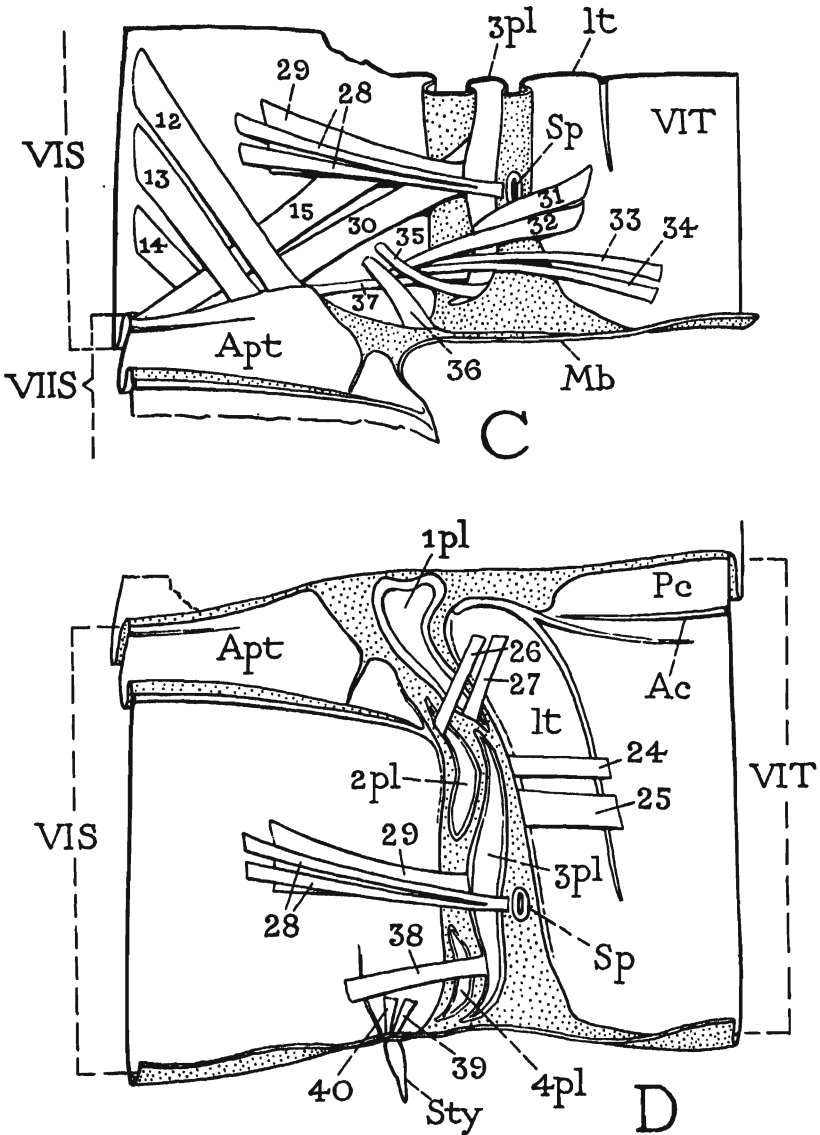

FIG. 24 C, D.—Outermost muscles of right half of sixth abdominal segment of *Heterojapyx gallardi*.

C, posterior part of right half of sixth segment and anterior part of seventh sternum. D, right half of sixth segment, showing segmental sclerites.

Ac, antecosta; Apt, sternal apotome; lt, laterotergal lobe; Mb, intersegmental membrane; Pc, precosta; 1pl, 2pl, 3pl, 4pl, pleural sclerites; Sp, spiracle; Sty, stylus; VIS, VIIS, sixth and seventh abdominal sterna; VIT, VIIT, sixth and seventh abdominal terga; 1-40, muscles of sixth segment (see text, pages 59, 62).

II. VENTRAL MUSCLES.—A group of *internal transverse intersegmental sterno-pleural fibers* (A, 7); an *oblique intersegmental sterno-sternal muscle* (A, 8); two *inner longitudinal intersegmental ventrals* (A, 9, 10); five *outer oblique intersegmental ventrals*, four of which are median (B, 11, 12, 13, 14), and one lateral (15).

III. LATERAL MUSCLES.—An *anterior intrasegmental tergo-pleural muscle* (A, B, 16); an *oblique intersegmental sterno-tergal muscle* (A, 17); an *oblique intrasegmental tergo-sternal muscle* (A, B, 18); a series of five *intrasegmental transverse tergo-sternal muscles* (A, 19, 20, 21, 22, 23); two short *lateral intra-tergal muscles* (D, 24, 25); two small *anterior intrasegmental tergo-pleural muscles* (D, 26, 27); two *median intrasegmental pleuro-sternal muscles* (C, D, 28, 29); an *oblique intersegmental pleuro-sternal muscle* (A, B, C, 30); a group of small external posterior lateral intrasegmental muscles (C, 31, 32, 33, 34, 35; D, 38); and two small posterior intersegmental muscles, one sterno-pleural (C, 36), the other pleuro-sternal (37).

IV. MUSCLES OF THE STYLUS.—Two small muscles (D, 39, 40) arising in the posterior lateral lobe of the sternum, inserted on the base of the stylus (*Sty*).

This complex and strongly developed musculature of *Heterojapyx*, which presumably is characteristic at least of the Japygidae, contains nothing to suggest that it represents the primitive plan of the body musculature of insects. It indicates, on the other hand, a highly specialized condition giving to these very small creatures a strength out of proportion to their size, which might enable them to burrow into hard soil or to insinuate their bodies into minute irregular spaces. In the multiplicity of individual muscles and in the diversity of their attachments, the body musculature of *Heterojapyx* resembles that of a caterpillar, but there is not the remotest likeness in detail, showing that the complexity of the muscle pattern in each case is but the result of a high degree of specialization adaptive to demands for dexterity of body movements. Both the caterpillar and *Heterojapyx* demonstrate the limitless potentiality of the insect muscular system, and make it all the more surprising that there are so few departures from the fundamental plan of muscle arrangement.

IV. THE ABDOMINAL APPENDAGES

There is no more vexing subject in the whole field of insect morphology than that of the homologies of the appendicular organs of the abdomen. Embryology shows at most that these organs are de-

rivatives of the segmental appendages; it gives no positive evidence as to what part of a primitive limb may be preserved in the definitive rudiment, since the latter, whatever it may be, develops directly from the embryonic rudiment, instead of following what we should suppose would be the course of the phylogenetic evolution of the organ. Comparative anatomy is more likely to foster illusions than to lead to definite results, for while certain categories of facts may seem to align themselves satisfactorily in some limited scheme of suggested homology, the plan invariably breaks down when wider generalizations are attempted. The writer, therefore, can offer nothing new on the fundamental morphology of the abdominal appendages of insects that is likely to be generally accepted. Even so, however, it will be sufficiently worth while to bring together the principal facts at present known concerning the anatomy of the various appendicular structures.

Though the appendages of the insect abdomen are rudimentary in the sense that they do not in any case represent a fully-developed limb, they are in all cases specialized by a structural adaptation to some particular use. The abdominal appendages of most interest to entomologists are those of the genital segments, and if we can discover a means of identifying these organs in the various insect orders, this discovery alone will be of much practical value, and it then becomes a less consequential matter if we can not fully decide the exact morphological nature of the organs themselves.

It is not possible, however, to study with profit any modified or specialized appendicular organ without having some concept of the nature of the primitive limb structure from which it has been derived. Since there are current several different ideas concerning the fundamental structure of a primitive arthropod limb, it is therefore necessary for a writer to make clear at the outset of a discussion the particular theory from which he proceeds. The following sketch will give briefly the view on this subject here taken, and a more extensive discussion at the conclusion of this section will examine the possibilities of interpreting the structures of the abdominal appendages of insects according to the terms of the theory adopted, which is essentially that of Börner (1921), though with differences in special applications.

A comparative study of arthropod appendages soon shows that the number of segments in the limbs, the relative size of the segments, and even the segmental musculature are so variable in different arthropod groups that none of these features can be used as a guide

for establishing the homologies of the segments or parts of the limb in any specific case. There are two joints of the limb, however, that recur in the same form in such a large number of appendages in the various arthropod groups as to suggest that they represent two primary points of flexure in the primitive ambulatory appendages, and that they may, therefore, be accepted as "constants" in the limb structure. These joints in a thoracic leg of an insect are the *coxotrochanteral joint*, and the *femoro-tibial joint* (the *Hüftgelenk* and the *Kniegelenk* of Börner, 1921). The first (fig. 25 A, *f-g*) divides the appendages into a basal region, or *limb basis* (*LB*), and a distal shaft, or *telopodite* (*Tlpd*), which is movable on the basis in a vertical plane by a horizontal, dicondylic hinge (*f-g*). The limb basis, in the

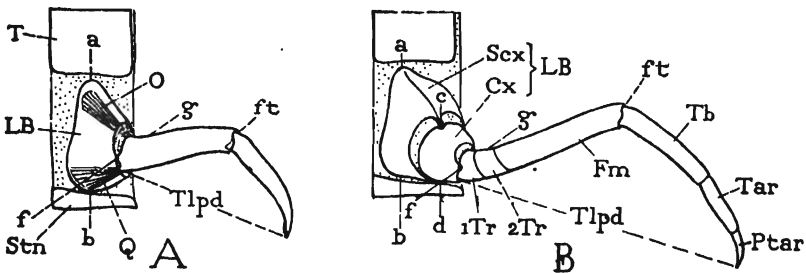

FIG. 25.—Diagrams showing the relation of the base of a leg to the body, and the theoretical progress of segmentation in the limb.

A, theoretically primitive appendage divided into a basis (*LB*) and a telopodite (*Tlpd*); the first movable antero-posteriorly on the body by a vertical axis (*a-b*) between tergum and sternum, the second movable on the basis in a vertical plane by a dicondylic, horizontal hinge (*f-g*) with levator and depressor muscles (*O*, *Q*) arising in the basis.

B, the fully segmented appendage: the basis divided into coxa (*Cx*) and subcoxa (*Scx*), the latter becoming the pleuron; the telopodite divided into the usual segments of an arthropod leg beyond the coxa.

sense here understood, includes the potential coxa and subcoxa, which in some arthropods are differentiated as distinct parts of the basis (B, *Cx*, *Scx*), the coxa then becoming the functional or movable base of the appendage, while the subcoxa becomes a part of the lateral and ventral walls of the supporting body segment. The second fundamental joint of the limb forms the "knee" (A, *ft*), and divides the telopodite into a proximal trochantero-femoral piece, and a distal tibio-tarso-praetarsal piece, the two movable on each other in a vertical plane by an articulation which is either monocondylic, or dicondylic.

If we conceive, thus, that the primitive arthropod limb is divided primarily into a basis and a telopodite, we should expect the basotelopodite joint to be the point of flexure most generally preserved,

and, as above noted, a joint does occur in the proximal part of practically all fully-developed arthropod appendages that is evidently, from its structure and musculature, to be identified as the joint between the primitive basis and the telopodite. This joint is the coxotrochanteral joint of an insect's leg. It is then reasonable to assume that the same joint is retained in reduced appendages, and that, finally, in an unsegmented limb rudiment it is the telopodite that has been lost, and that the part which remains is the basis.

The appendages of arthropods are prone to develop appendicular processes on the limb segments. Such processes may be either *endites* or *exites*, or both forms may occur on the same segment. Endites are developed particularly on the basis, serving as masticatory lobes on the gnathal appendages. In the Crustacea, exites of the basis are often gill-bearing organs, and an exite of the proximal segment of the telopodite commonly forms an outer branch of the appendage known as the exopodite. The study of rudimentary appendages becomes complicated by the fact that it is often difficult or impossible to determine whether a persisting part represents the main shaft of the limb, or an appendicular process of the latter.

BODY APPENDAGES OF CHILOPODA

The centipedes furnish a good example of arthropods that have retained a long series of body appendages preserving the form and

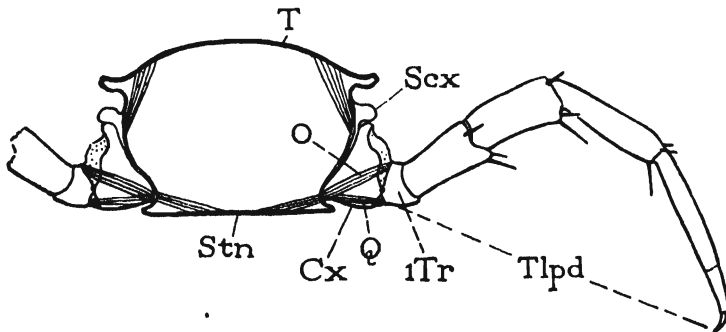

FIG. 26.—Somewhat diagrammatic cross section of a body segment of *Lithobius*, showing the relation of the subcoxa (*Scx*) and coxa (*Cx*) to the body and to the telopodite (*Tlpd*).

function of ambulatory limbs. Each appendage of the pregenital region of the body is implanted in a membranous pleural area of its supporting body segment between distinct tergal and sternal plates (figs. 26, 27 A). The movable basal piece of a typical chilopod leg is a small segment generally termed the coxa, or coxopodite (*Cx*). The

coxa supports the six-segmented telopodite (fig. 26, *Tlpd*), the proximal segment of which, or first trochanter (*1Tr*), is articulated to the coxa by a typical coxo-trochanteral hinge (fig. 25 B, *f-g*). Surrounding or partly surrounding the base of the coxa, in most of the pre-genital segments but the last, is an area of the body wall containing one or several small sclerites (fig. 27 A, *Scx*). These sclerites appear to belong to the subcoxal region of the primitive limb basis, since upon this region are inserted the tergal muscles of the appendage, and within it arise muscles of the coxa. The coxa turns antero-posteriorly upon the subcoxa by an approximately dorso-ventral axis (fig. 25 B, *c-d*).

The large terminal pair of legs of a chilopod borne by the last pre-genital segment (fig. 27 A, *Tlpd*) are supported each upon a single large plate in the lateral segmental wall (*LB*). The basal joint of each of these legs clearly corresponds with the coxo-trochanteral joints of the preceding appendages, and a comparison of the leg-bearing plate of this segment (*LB*) with the coxal and subcoxal sclerites of the segments immediately anterior to it leaves little doubt that the single "pleural" plate of the last segment represents both the coxa and the subcoxa of the preceding segments (*Cx*, *Scx*). In other words, the large pleural plates supporting the legs of the last pre-genital segment are the limb bases (*LB*) undivided into coxal and subcoxal parts as in the other segments. The condition here, of course, may be the result of a secondary union of the subcoxal sclerotizations with the coxa, but it gives a convincing demonstration of the potential unity of the coxal and subcoxal regions of the limb basis, and at least suggests a primitive condition in which the limb basis occupied the lateral walls of the body segment between the tergal and sternal plates (*A*, *C*, *IT*, *lStn*). The levator and depressor muscles of the telopodite of the last pair of legs arise on the plate of the limb base and on the sternum (*D*, *O*, *Q*), and have their insertions on the first trochanter (*1Tr*).

The basal structure of the last pair of legs in the chilopoda is paralleled exactly in that of the legs of more generalized Arachnida as in the Phalangidae (fig. 46 Λ), in which the free part of each leg is supported on a large basal plate (*LB*) implanted in the lateral wall of the body. Börner (1904) regards the single basal plate of the terminal pair of chilopod legs as the united coxa and subcoxa; but in the Arachnida, he concludes (1921) that subcoxae are absent and that the plates supporting the telopodites are the coxae alone. It is not clear why structures so evidently similar should be differently interpreted.

In the Diplopoda the free basal segment of the leg, judging from its structure and the nature of its articulation with the next segment, would appear to be the coxa, and since the sternal plates of the Diplopoda surround the bases of the legs, we may conclude with Börner (1921) that the definitive sterna include the subcoxae. Silvestri (1903), however, regards the free basal segment of the diplopod leg as the subcoxa, and the next segment as the coxa, though the latter

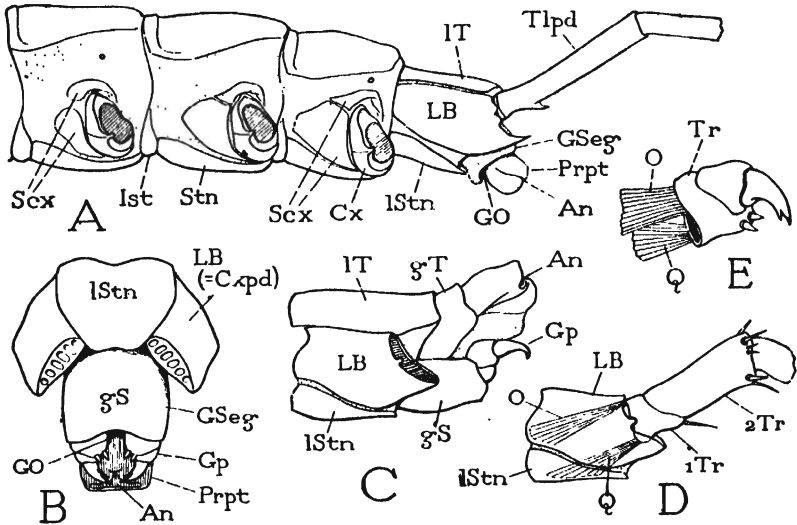

FIG. 27.—Appendages and terminal body structures of Chilopoda.

A, posterior part of body of *Scolopocryptops sexspinosus*, telopodites removed except from last segment, showing union of subcoxal sclerites with coxa in large pleural plate (LB) on last pregenital segment. B, ventral view of genital and pregenital segments of *Lithobius*. C, lateral view of same. D, base of pregenital appendage of *Lithobius*. E, telopodite of right gonopod of *Lithobius*, mesal surface.

An, anus; Cx, coxa; C.pd, coxopodite; GO, gonopore; Gp, gonopod; gS, sternum of genital segment; GSeg, genital segment; Ist, intersternal sclerite; LB, limb basis; IStn, sternum of pregenital segment; IT, tergum of pregenital segment; O, levator of telopodite; Prpt, periproct; Q, depressor of telopodite; Scx, subcoxa; Stn, segmental sternal plate; Tlpd, telopodite; iTr, first trochanter; zTr, second trochanter (prae-femur).

segment has all the structural features and usual relations of a first trochanter.

Following the last leg-bearing segment in the Chilopoda comes the definitive genital segment (fig. 27 A, GSeg), beyond which is the periproct (Prpt), or anal segment. According to Heymons (1901) the genital region of the body contains two small somites in the embryo, parts of both of which are sometimes retained in the adult stage. The

apparently single genital segment of the adult may be a mere membranous ring (*A*, *GSeg*), or it may be a well-developed segment with dorsal and ventral plates (*C*, *gT*, *gS*). In *Lithobius* the ventral plate of the genital segment bears laterally on its posterior margin a pair of small, three-segmented appendages, the *gonopods* (*B*, *C*, *Gp*, *E*), the basal muscles of which (*E*, *O*, *Q*) arise on the sternal plate of the segment. The definitive sternum of the genital segment, therefore, is clearly a composite plate which includes the true bases of the genital appendages united with the primitive segmental sternum. The free genital appendages, then, are not the entire gonopods, but are the telopodites of the latter, and their muscles (*E*, *O*, *Q*) are the levators and depressors of the first trochanter (*Tr*).

In the males of many insects of the higher orders the structure of the second genital segment and its clasperlike appendages (the harpes) closely resembles the condition in *Lithobius*. Though the claspers are but one-segmented, they are movable by muscles arising in the gonopod bases, and the latter are generally more or less united with the sternum. In the insects, however, it is not so clear that the claspers are the true telopodites of the gonopods, since there is evidence to suggest that they may be other appendicular processes of the bases of the genital appendages.

ABDOMINAL APPENDAGES OF CRUSTACEA

All the body segments of the Crustacea anterior to the telson are usually provided with well-developed appendages. In the lower crustacean groups, the appendages of the entire body series, as in *Apus* (fig. 28 A), are fundamentally uniramous in form, though the various segments may be provided with endite and exite lobes. Each limb consists of a basis (*LB*), called the coxopodite, and of a telopodite (*Tlpd*). The frequent biramous form of crustacean appendages (*C*) is evidently the result of the hyper-development of an exite of the basal segment of the telopodite (the first trochanter, or basipodite, *Bspd*). The shaft of the telopodite beyond the basipodite then becomes the endopodite (*Endpd*). The exite lobes are movable by muscles arising in the limb segments that support them.

The abdominal appendages of the Malacostraca are typically biramous limbs (fig. 28 C) in which the endopodite (*Endpd*) is usually reduced to the size of the exopodite (*Expd*). The basis, or coxopodite (*Cxpd*), and the basipodite (*Bspd*) may be distinct segments, but in some forms (*B*) they are united in a single protopodite (*Prtpd*). In certain cases the abdominal appendages become practically unira-

mous by a suppression of the endopodite (B, *Endpd*), or by its conversion into a genital process. In such cases the functional or locomotory shaft of the appendage is the exopodite (*Expd*). A crustacean limb of this type of structure furnishes an analogy with the abdominal limbs of Thysanura on the assumption that the stylus of the latter (fig. 31 A, *Sty*) is the exopodite, and that the endopodite has been entirely suppressed, or preserved only in the gonapophyses of the genital appendages (B, *Gon*).

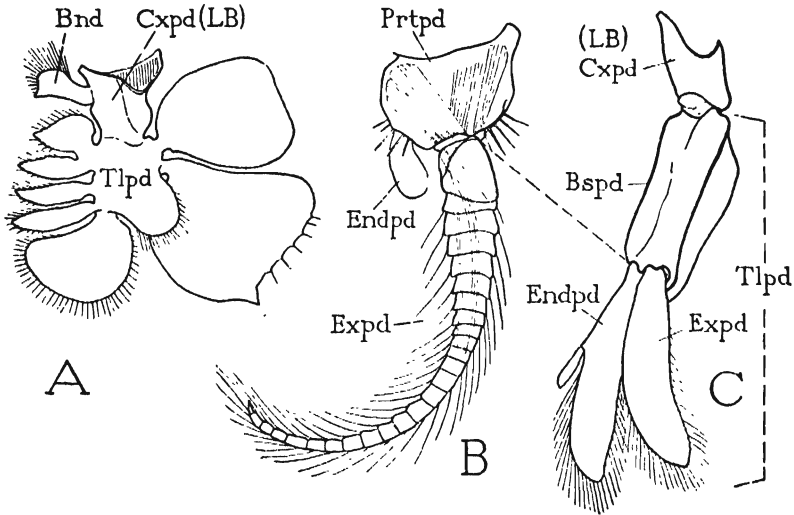

FIG. 28.—Abdominal appendages of Crustacea.

A, *Apus longicaudata*, appendage from posterior part of body, left, anterior surface. B, *Anaspides tasmaniac*, third abdominal appendage of left side, anterior surface. C, *Spirontocaris groenlandicus*, abdominal appendage of left side, anterior view.

Bnd, basendite; *Bspd*, basipodite; *Cxpd*, coxopodite, or limb basis; *Endpd*, endopodite; *Expd*, exopodite; *LB*, limb basis, or coxopodite; *Prtpd*, protopodite (united basis and basipodite); *Tlpd*, telopodite.

The genital claspers of the higher insects, which are clearly homologues of the abdominal styli of the Thysanura, may thus be likened either to the gonopods of the Chilopoda (fig. 27 C, *Gp*), if we assume that they are the main shafts of the telopodites, or to the abdominal appendages of such crustaceans as *Anaspides* (fig. 28 B), if we assume that they are exites of the appendages. As will later be shown, however, it is difficult to obtain positive evidence as to the nature of the insect abdominal styli; whether they are likened to the main shaft of the telopodite or to an exopodite branch depends largely on the student's bias toward a myriapodan or a crustacean ancestry for the insects.

THE ABDOMINAL APPENDAGES OF PROTURA.

A pair of short, cylindrical appendages is present on each of the first three abdominal segments of all adult Protura. These appendages arise from the membranous parts of these segments between the posterior angles of the tergal and sternal plates. They are best developed in Eosentomidae, where the three pairs are alike in size and structure, and each organ (fig. 29 B) consists of two segments and a small terminal vesicle (*v*) which is eversible and retractile. In Acerentomidae (A) the appendages of the first pair are like those of the Eosentomidae, but the second and third pairs are simple, tuberculiform

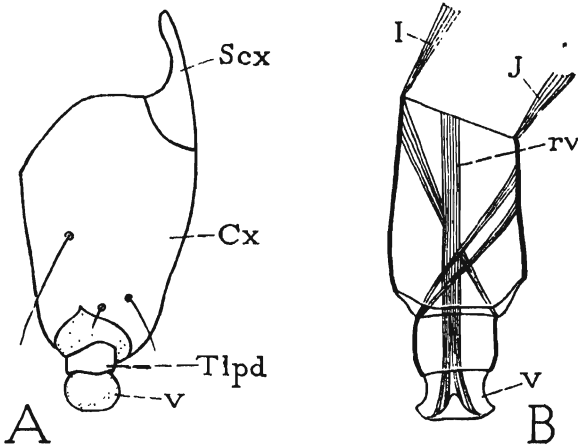

FIG. 29.—Abdominal appendages of Protura.

A, *Eosentomon germanicum*, abdominal leg (from Prell, 1913). B, *Acerentomon doderoi*, first abdominal leg (from Berlese, 1910).

Cx, coxa; *I*, promotor muscle of limb base; *J*, remotor muscle; *rv*, retractor of vesicle; *Scx*, subcoxa; *Tlpd*, rudiment of telopodite; *v*, terminal vesicle.

protuberances, unsegmented and lacking the terminal vesicle. Each appendage of the larger type in the two families, as described by Berlese (1910), is movable by two tergal muscles (B, *I*, *J*) inserted on the basal segment, one anteriorly, the other posteriorly. The second segment is provided likewise with two muscles, one arising anteriorly, the other posteriorly in the proximal segment, the two crossing each other axially to be inserted on opposite sides of the base of the distal segment. The terminal vesicle is retracted by a single large muscle (*rv*), which takes its origin mesally on the base of the first segment of the appendage, and is inserted on a central depression of the ventral face of the vesicle. The extrusion of the vesicle is evidently brought about by blood pressure from within the body.

There appears to be no reason to doubt that these abdominal appendages of the Protura are remnants of true post-thoracic limbs. They have, as Berlese points out, a certain resemblance to the abdominal legs of lepidopterous larvae; but a closer comparison shows differences in the segmentation and musculature which makes it seem probable that there is no close genetic relation between the two sets of organs. Prell (1913), in his study of *Eosentomon germanicum*, finds at the base of each abdominal leg two small sclerotizations which he regards as remnants of the subcoxa (fig. 29 A, *Scx*). The large basal segment he believes is the coxa (*Cx*) and the smaller distal segment the rudimentary telopodite (*Tlpd*). The homology of the terminal vesicle (*v*) is doubtful. The organ does not appear to represent the eversible sacs of Thysanura, since the latter are borne by the limb bases (fig. 4, *Vs*); it might be, however, as Prell suggests, the praetarsus, since it has a certain resemblance to the vesicular praetarsus of Thysanoptera. The most likely homologue of the proturan leg vesicles is to be found in the eversible sac on the colophore of Collembola (fig. 30 B, *v*), which probably represents the united vesicles of a pair of fused appendages.

GENERAL STRUCTURE OF THE ABDOMINAL APPENDAGES OF INSECTS

Most of the appendicular organs found on the abdominal region of insects fall into two quite distinct categories distinguished by the insertion points of their muscles. In those of one group the muscles are inserted *on the base* of the organ; in those of the other the muscles *traverse* the organ and are inserted *within its distal extremity*. Appendicular structures of the first class are typically stylus-like in form, though they take on various other shapes. They include such organs as the abdominal styli of the Thysanura and the more generalized Pterygota, the furcula of Collembola, the gills of ephemerid larvae, the terminal claws of trichopterous larvae, the lateral abdominal appendages of larvae of Sialidae, the gonapophyses, the movable claspers of male pterygote insects, and the cerci. Organs of the second class are sac-like or tubular in form, and are usually retractile and eversible. They include the colophore of Collembola, the eversible vesicles of Thysanura, the gill-bearing tubercles of some sialid larvae, and the plantar lobes of the abdominal legs of larvae of Lepidoptera and chalastogastrous Hymenoptera.

If we could accept the two categories of abdominal appendicular structures, distinguished by the muscle insertions, as morphological groups of organs, the study of the abdominal appendages of insects

would be much simplified. But, unfortunately, there are other features than the muscle insertions to be considered, such as the origins of the muscles and the position of the organs on the body, that make it doubtful if either constitutes a homogeneous group. Furthermore, organs of each type frequently occur together supported on a common basal structure, and the latter must then be reckoned as an essential part of the primitive appendage, of which the free, movable parts are but accessory structures of one kind or another. Any attempt to make theoretical generalizations on the primitive form or on the homologies of the abdominal appendages of insects will be premature until we have more closely examined the structure of the principal types of such organs as occur in both larval and adult stages of the various insect orders.

The abdominal appendages of insects fall into three groups corresponding with the subdivision of the abdomen into pregenital, genital, and postgenital regions. The appendages of the pregenital segments may be designated the *pregenital appendages*; those of the genital segment are the *gonopods*; those of the first and second postgenital segments are conveniently termed the *pygopods* and *uropods*, respectively. The pygopods are the anal legs, or postpedes, of holometabolous larvae, and probably the *socii* and so-called "cerci" of holometabolous adults. The uropods are the true cerci.

THE ABDOMINAL APPENDAGES OF COLLEMBOLA

The well known appendicular organs on the abdomen of Collembola include organs of each type of structure as defined above according to the muscle insertions.

The *collophore* (fig. 30 A, *Col*) is a large, thick, tubular pouch of the body wall projecting from the sternal region of the first abdominal segment. In most species it ends in a bilobed terminal vesicle (B, *v*), which is ordinarily retracted but is capable of being protruded by blood pressure. The entire collophore is traversed by a pair of large muscles (*rv*) arising on the tergal region of the body and inserted on the lobes of the terminal vesicle. The structure of the collembolan collophore thus suggests that it is formed by the union of a pair of abdominal appendages resembling those of the Protura (fig. 29), though in the latter the retractor muscle (B, *rv*) arises in the base of the appendage, and the appendage itself is movable by two muscles (*I, J*) arising in the body and inserted on its base. In some of the Collembola each lobe of the vesicle is produced into a long eversible tube.

The typical spring, or leaping organ of the Collembola, known as the *furcula* (fig. 30 D), has quite a different type of structure from that of the collophore. It consists of a large median base, the *manubrium* (*mn*), and of two slender arms, each of which is subdivided into a long proximal segment, the *dens* (*d*), and a short terminal segment, or *micro* (*m*). On the base of the manubrium are inserted flexor and extensor muscles arising in the fourth and third abdominal segments, but, as already observed, these muscles apparently belong to the system of longitudinal dorsal and ventral body muscles, and are not specifically muscles of the spring. In *Tomocerus vulgaris*

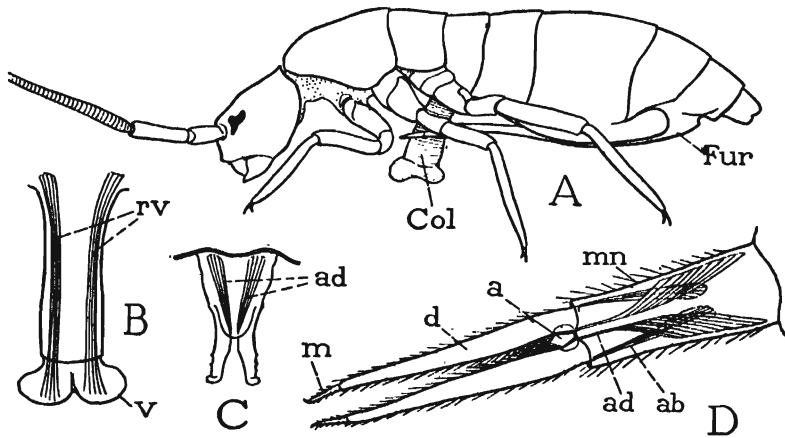

FIG. 30.—Abdominal appendages of Collembola. *Tomocerus vulgaris*.

A, lateral view of insect. B, anterior view of collophore. C, tenaculum. D, furcula.

a, aperture between bases of furcular arms receiving prongs of tenaculum; *ab*, abductor muscle; *ad*, adductor muscle; *Col*, collophore; *d*, dens; *Fur*, furcula; *m*, micro; *mn*, manubrium; *rv*, retractor muscles of vesicle; *v*, terminal vesicle of collophore.

(fig. 30) each of the arms of the furcula is provided with an abductor muscle (D, *ab*) and an adductor muscle (*ad*) having their origins in the manubrium. According to Quiel (1915) adductor muscles are absent in *Orchesella cincta*, though he says a few obliquely transverse fibers are present in the manubrium. It is possible that Quiel did not observe in studying sections that these transverse fibers are attached on each side to a slender adductor tendon of the dens. The structure of the furcula readily suggests that it is composed of a pair of segmental appendages united by a fusion of the coxae, which become the manubrium, while the reduced telopodites become the arms.

The minute *tenaculum* of the third abdominal segment (fig. 30 C) looks like a miniature furcula, and likewise suggests that it has been produced in the same manner by the union of the bases of a pair of appendages.

THE ABDOMINAL APPENDAGES OF THYSANURA

It is in the Thysanura that the abdominal appendages best preserve the fundamental structure characteristic of the abdominal appendages of adult Pterygota, as shown in the gonopods of the latter group; but, as will be seen later, it appears that the abdominal appendages have a more primitive form in the larvae of Ephemera and in the larvae

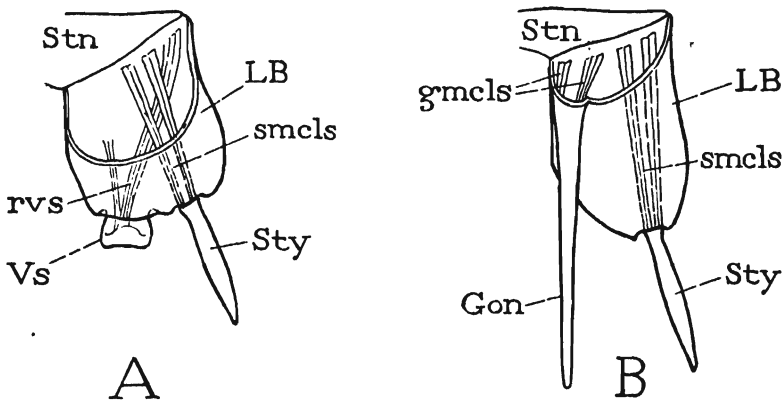

FIG. 31.—Diagrams of structure of abdominal appendages of Thysanura and Pterygota.

A, a typical pregenital appendage. B, a gonopod, or genital appendage.

gmcls, muscles of gonapophysis; *Gon*, gonapophysis; *LB*, limb basis, usually a lobe or plate of body wall; *rvs*, retractator muscles of eversible vesicle; *smcls*, muscles of stylus; *Stn*, sternum; *Sty*, stylus; *Vs*, eversible and retractile vesicle.

of certain holometabolous insects. The thysanuran appendages retain most completely their independence in the Machilidae.

The appendages of the pregenital region of the abdomen are typically developed on each of the pregenital segments except the first in Machilidae (fig. 4, II, VI), and those of each pair are distinct from the small median sternal plate (*Stn*), though their bases (*LB*, *LB*) are ankylosed with the latter, and are united medially with each other. Each appendage consists of a broad *basal plate* (fig. 31 A, *LB*), of a *stylus* (*Sty*) borne by the distal free margin of the basal plate, and of an *eversible sac*, or *vesicle* (*Vs*), lying mesad of the stylus and retractile into the basal plate (fig. 4, II, *Vs*). The posterior part of the basal plate projects from the ventral wall of the

abdomen as a free flap with a membranous dorsal wall (fig. 32 B). Both the stylus and the eversible sac are provided with muscles arising within the basal plate (figs. 31 A, 32 B, *smcls*, *rvs*). The muscles of the stylus are inserted on the base of the stylus; the muscles of the vesicle traverse the latter, when the vesicle is everted, to be inserted within its distal extremity.

The appendages of the pregenital segments are never developed into any other form in the Thysanura than that which they have in the Machilidae, but they may be variously reduced, or united with the sternum. The styli and eversible sacs are sometimes absent, or either organ may occur alone (fig. 4, I, VIII). A pair of vesicles is frequently present on each basal plate, but the stylus never occurs

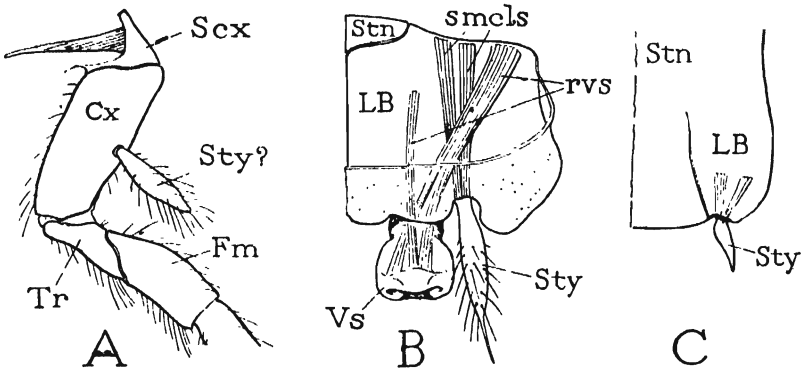

FIG. 32.—Appendages of Thysanura and Dicellura.

A, base of metathoracic leg of *Nesomachilis maoricus*, showing styliform spur on coxa. B, typical structure of a pregenital appendage of same, dorsal view. C, posterior lateral part of sternum of *Heterojapyx gallardi* with united limb basis bearing the stylus.

in duplicate. In Lepismatidae the basal plates of the appendages in each segment are fused with the primary sternum to form a large zygosternum, which is the definitive sternal plate of the segment. The same is true in the Dicellura, though the regions of the limb bases may remain partially separated from the region of the primary sternum (fig. 32 C).

The basal plates of the thysanuran appendages are commonly called "coxae" (or "coxites") by American entomologists, while certain European entomologists call them "subcoxae." The idea that the plates are coxae is based chiefly on the fact that in the Machilidae stylus-like spurs occur on the coxae of the second and third pairs of thoracic legs (fig. 32 A, *Sty?*), which appear to be homologues of the abdominal styli. The question of the possible identity of the

thoracic and abdominal styli will be discussed in the concluding part of this Section, but in any case the term "coxite" should not be used to designate the stylus-bearing plates, because the word can properly mean only "a part of a coxa." Since the writer is inclined to believe that the abdominal plates in question represent both the coxae and the subcoxae of the thoracic appendages, they are here termed simply the limb bases, or basal plates.

The gonopods, or appendages of the genital segments, have the same structure as the pregenital limbs in Thysanura, with the exceptions that they always lack eversible vesicles, and that typically each bears a median genital process, or *gonapophysis* (fig. 31 B, *Gon*). Two pairs of gonapophyses are regularly present in the females of

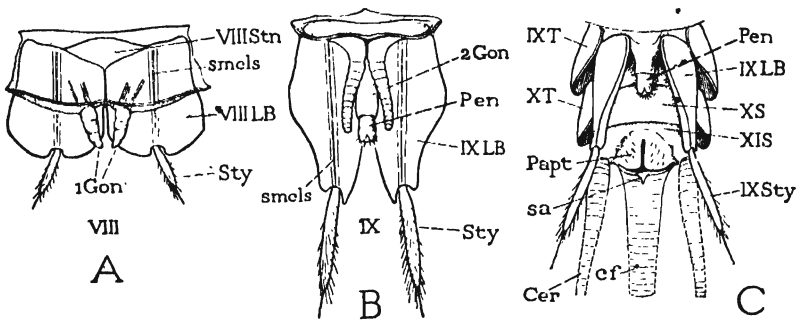

FIG. 33.—Genital and postgenital segments of Machilidae.

A, *Machilis variabilis*, male, ventral plates of eighth abdominal segment, dorsal view, with small first gonapophyses (*1Gon*). B, ventral plates of ninth segment of same, dorsal view, showing second pair of gonapophyses (*2Gon*) at sides of median penis (*Pen*). C, *Nesomachilis maoricus*, male, posterior part of abdomen, ventral view, showing absence of gonapophyses, and ventral structure of eleventh segment, bearing paraprocts (*Papt*), caudal filament (*cf*), and cerci (*Cer*).

Thysanura, one pair borne by the gonopods of the eighth segment, the other by the gonopods of the ninth segment. In the male, gonapophyses are known to occur on the gonopods of the eighth segment only in certain forms of *Machilis* (fig. 33 A, *1Gon*); they are usually present on the gonopods of the ninth segment (B, *2Gon*), but they may be absent from both genital segments (C). Each gonapophysis, when present, arises from the median, basal angle of the free dorsal surface of the stylus-bearing plate, and is provided with short muscles (fig. 31 B, *gmcls*) arising within the supporting plate and inserted on its base.

Between the bases of the gonopods of the ninth segment in the male is a short membranous *penis* (fig. 33 B, C, *Pen*), a tubular evagination

of the body wall from behind the region of the ninth sternum, having the opening of the ejaculatory duct at its extremity.

The thysanuran gonopods contain, in their simplest form, the fundamental elements of the organs of copulation and oviposition of pterygote insects. In the male the gonapophyses of the second gonopods become the so-called *parameres* of the copulatory apparatus; in the female, the first and second gonapophyses become the *first* and *second valvulae* of the ovipositor, and the basal plates of the second gonopods form the *third valvulae*, when the last are present.

The uropods, or cerci, of the Thysanura are typically long, multi-articulate filaments (fig. 7 A, *Cer*) borne by the eleventh segment (B, XI). In the Dicellura the abdomen contains only 10 segments, and the uropods, therefore, in this group appear to belong to the tenth segment. They are filamentous in *Campodea*, styliform in Projapygidae, and take the shape of large pinchers in Japygidae (fig. 40 C, *Cer*). The uropods differ from the preceding appendages in that they are not differentiated into a basal plate and a stylus, and they bear neither eversible sacs nor processes corresponding with the gonapophyses.

THE ABDOMINAL GILLS OF EPHEMERID LARVAE

The abdominal gills of ephemeropterid larvae, together with the lateral lobes of the body wall supporting them (fig. 34 A), appear to be appendages of a more primitive form than the abdominal appendages of the Thysanura. Their structure, with certain modifications, is repeated in the abdominal appendages of several groups of holometabolous larvae; but it does not furnish the basis of the structure of the gonopods in adult pterygote insects, which, as already stated, is to be derived from that of the gonopods of the Thysanura.

The ephemeropterid larval gills have various shapes, some being tapering stalks, either single or double, fringed with filaments (fig. 34 A, B, *Brn*), while others are expanded into broad plates; but, whatever the form, each organ is movably attached by its base to a large lateral lobe of the body wall (*LB*). The gill is movable by muscles arising in the ventral part of the supporting lobe (A, B, *bmcls*).

The gill-bearing lobes are not movable, since there are no body muscles inserted upon them. The vertical lateral muscles of the abdominal segments extend from the tergum to the edge of the sternum mesad of the gill lobes (fig. 15 A, *1l*, *2l*, *3l*, fig. 34 A, *l*). The gill-bearing lobes therefore have the character of limb bases implanted in the pleural areas of the segments between the tergal and sternal

plates (compare *LB* of fig. 34 A with *LB* of fig. 1 A). The lateral and ventral surfaces of each lobe are often separated by a sharp fold or ridge (fig. 34 B, *LB*), and the ventral part of the lobe may be more or less united with the sternum of its segment (*Stn*). The gill (*Brn*) arises from the posterior end of the lateral surface of the supporting lobe, and is usually provided with four muscles inserted on its base (*C*). The branchial muscles, as above noted, take their origins on the ventral plate of the supporting lobe (*B*), and therefore

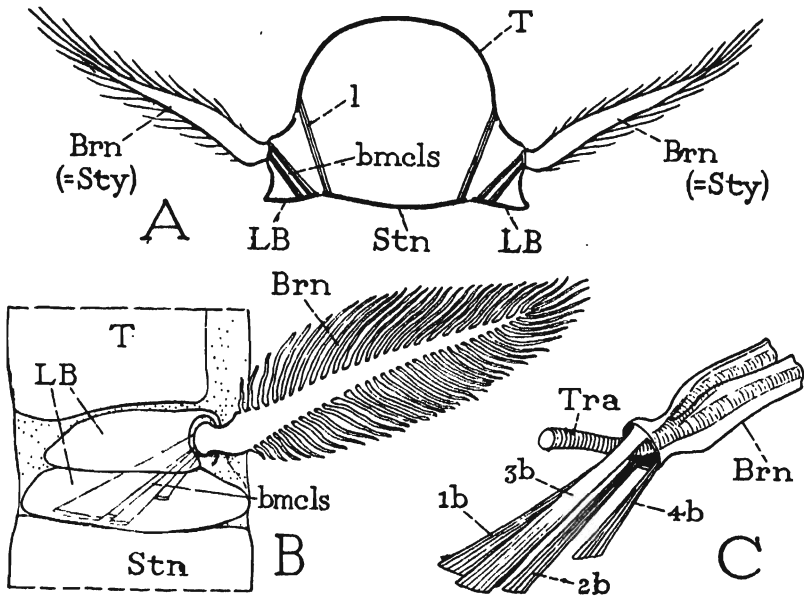

FIG. 34.—The abdominal gill-bearing appendages of ephemerid larvae.

A, diagrammatic cross section of abdominal segment, showing limb base lobes (*LB*) bearing gill appendages (*Brn*), which are evidently the styli, each movable by muscles (*bmcls*) arising in the bases; the lateral body muscles (*l*) extend from tergum to sternum.

B, external view of a gill and its supporting lobe (*LB*), in which arise the gill muscles (*bmcls*).

C, musculature and tracheation of a gill, lateral view.

not on the sternum, as stated by Dürken (1907), who did not distinguish the ventral plate of the gill basis from the true segmental sternum.

The old idea that the ephemerid larval gills are appendages of the dorsum is no longer tenable. The organs are very evidently rudiments of segmental appendages, as claimed by Heymons (1896a, 1896b) and by Börner (1909), each being composed of a basis (*LB*), and of a terminal appendicular part (*Brn*) movable on the basis by mus-

cles arising in the latter. The gill bases are interpreted by Börner as the subcoxae of the abdominal appendages, since they follow exactly in line with the subcoxal, or "pleural," plates of the thorax. The gills, therefore, Börner contends, are the equivalents of the legs, and the proximal end of each represents the coxa. On the other hand, we might assume that the gill basis includes the equivalents of both the subcoxa and the coxa of a thoracic leg, in which case the gill shaft or plate might be supposed to be the telopodite with its proximal end representing the first trochanter. The presence of the gill muscles arising in the gill basis suggests this homology, since the muscles are comparable with the trochanteral muscles of a leg (fig. 26, *O*, *Q*). But again, the gill resembles the stylus of a thysanuran appendage, and there is doubt as to whether the abdominal styli are true telopodites or secondary appendicular processes of the coxae.

Leaving aside, for the present, the question of homologies between the parts of the abdominal appendages and those of the thoracic appendages, a comparison of the abdominal appendages of the ephemerid larva with the abdominal appendages of *Thysanura* leaves little doubt that the gill-supporting lobes of the former are the equivalents of the stylus-bearing plates of the latter, and that the gill stalks or plates are the homologues of the styli. Neither the abdominal gills of ephemerid larvae nor the styli of *Lepisma* are present on the early postembryonic stage of the insect. In the newly hatched larva of *Ephemerella vulgata*, according to Heymons (1896), there are lateral protuberances of the abdominal segments, especially prominent on segments II and VII, which are derived during embryonic development from the embryonic limb rudiments. The gills first appear as outgrowths from these abdominal lobes about four days after hatching. The styli of *Lepisma saccharina*, Heymons (1897) says, appear likewise a considerable time after hatching, and arise from the parts of the ventral plates of the eighth and ninth abdominal segments that are derived from the "Anlagen" of the embryonic appendages.

LATERAL ABDOMINAL APPENDAGES OF SIALID AND COLEOPTEROUS LARVAE

The larva of *Sialis* (fig. 35 A) presents at least an excellent imitation of an insect that has carried the primitive polypod condition into a postembryonic stage. The long, tapering, segmented, appendicular organs, usually termed "gills," projecting from the sides of the first seven abdominal segments have a striking resemblance to

legs. Each appendage (C) is a hollow process of the body wall, distinctly jointed, and composed of six segments, of which the proximal three are relatively thick, while the region of the distal three is slender and rapidly tapering to the apex.

Each appendage is supported on a lateral lobe of the body segment (fig. 35 C, LB). The series of lobes appears at first glance to belong to the dorsum of the abdomen, but each one, though so closely amalgamated with the tergum that the spiracle appears to be situated on its dorsal part, really occupies a pleural position between the tergum

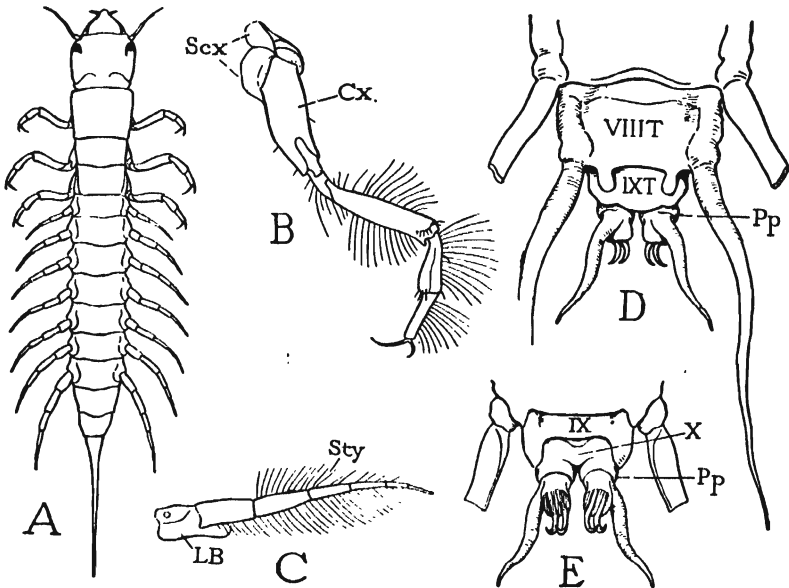

FIG. 35.—Abdominal appendages of sialid larvae.

A, larva of *Sialis*, showing jointed appendages of abdomen. B, metathoracic leg of *Sialis* larva, with subcoxal sclerites at its base. C, abdominal appendage of *Sialis* larva, showing division into basis (LB) and jointed stylus (Sty). D, posterior end of larva of *Chauliodes*, dorsal view, showing pygopods (Pp) of terminal segment. E, the same, ventral view.

and the sternum of its segment. The lumen of each lobe is separated from the general body cavity by a vertical sheet of tergo-sternal lateral muscles, and within the lobe arise anteriorly and posteriorly muscles inserted on the base of the movable shaft of the appendage. It is clear, therefore, that we have here an organ corresponding in every respect with a gill-bearing appendage of an ephemerid larva (fig. 34 B), and that in both of these structures the basal lobe represents the stylus-bearing plate of *Machilis*, and the movable distal appendage the stylus.

The distinct segmentation of the abdominal appendages of the *Sialis* larva almost unavoidably gives the impression that these organs are the true telopodites of the abdominal limbs. The impression, moreover, comes close to a conviction when it is discovered that each appendage is provided with internal muscles in addition to those inserted on its base. The presence of these muscles was first mentioned by Heymons (1896a); and it can be demonstrated by dissection and staining of specimens preserved in alcohol that bundles of muscle fibers are present in at least each of the first three segments, inserted on the bases of the second, third, and fourth segments, but it is difficult to make an exact study of them without properly prepared material. The slender distal part of the shaft beyond the third segment is penetrated by a branched trachea, and this part of the appendage might serve as a tracheal gill; but the strong musculature of the proximal part of the organ, and the long hairs that fringe the segments, suggest that the abdominal appendages of the *Sialis* larva have an important locomotory function.

In the sialid genera *Chauliodes* and *Corydalus* the larvae are likewise provided with long, lateral abdominal appendages, a pair being present on each of the first eight segments, and a terminal pair on the last segment (fig. 36 B). In these genera, however, the appendages are simple, tapering, hollow processes of the integument, unsegmented, and containing no muscles. Each is supported on a lateral lobe of the body wall (*LB*).

The basal lobes of the lateral appendages of the *Corydalus* larva are large and prominent as seen in a transverse section of an abdominal segment (fig. 36 C, *LB*, *LB*). Each projects laterally beyond the attachments of a set of strong tergo-sternal lateral body muscles (*l*); and on the inner margin of the ventral wall of the lobe arise three muscles (*D*, *smcls*), one anteriorly and two posteriorly, which are inserted on the base of the distal appendicular process. Here again, therefore, we find repeated the same structures that occur in the ephemeropterid larval gills and in the thysanuran abdominal appendages. In the *Corydalus* larva the appendage-bearing lobes of the abdomen fall in line with the subcoxal lobes of the thoracic segments (fig. 36 A, *Scx*), rather than with the long coxae (*Cx*); but the muscles of the abdominal appendages (*D*, *smcls*), taking their origins in the supporting lobes, can be compared only with the basal muscles of the leg telopodite (*A*, *O*, *Q*) inserted on the trochanter. The abdominal lobes, therefore, would appear to contain both the subcoxal and the coxal parts of the limb bases.

The *Corydalus* larva differs from the *Sialis* and *Chauliodes* larvae in that the basal lobes of the first seven abdominal appendages bear each a large ventral tubercle supporting a circle of respiratory filaments (fig. 36 B, *Vs*). When the filaments are removed it is seen that each tubercle is subdivided distally into three terminal lobes (C, *Vs*), and dissection reveals the fact that the tubercle is provided with a large

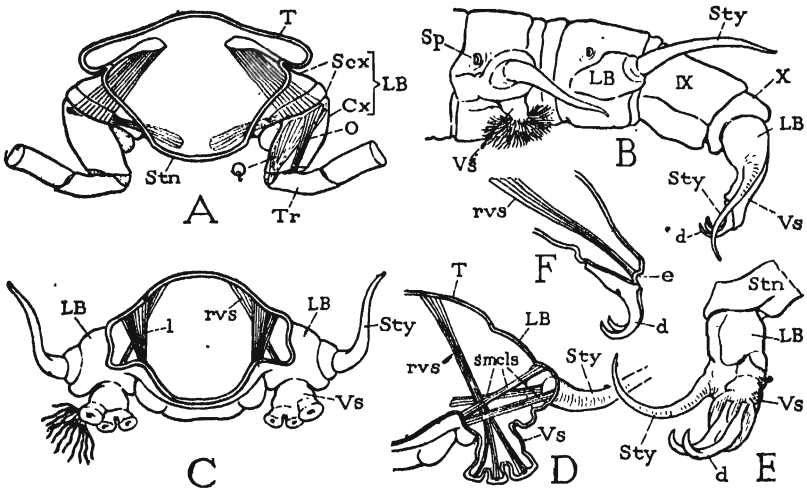

FIG. 36.—Thoracic and abdominal appendages of the larva of *Corydalus cornutus*.

A, transverse section through anterior end of metathorax, showing subcoxal lobes (*Scx*) above bases of coxae (*Cx*), and levator and depressor muscles of trochanter (*O*, *Q*) arising in coxa.

B, last four segments of abdomen, showing segmental appendages.

C, transverse section through posterior part of an abdominal segment, seen from behind, showing limb base lobes (*LB*) supporting each a stylus (*Sty*), and a retractile gill-bearing tubercle (*Vs*).

D, section through base of right abdominal appendage and gill tubercle, seen from behind, showing muscles of stylus and gill tubercle.

E, antero-mesal view of right appendage (pygopod) of tenth abdominal segment.

F, section of terminal appendage, showing insertion of retractor muscles behind bases of claws.

Cx, coxa; *d*, claws (crochets); *e*, insertion point of retractor muscles of claw-bearing tubercle (planta); *l*, lateral body muscles; *LB*, limb basis; *O*, *Q*, muscles of trochanter; *rvs*, retractor muscle of gill-bearing or claw-bearing lobe of appendage; *Scx*, subcoxa; *smcls*, muscles of stylus; *Sp*, spiracle; *Stn*, sternum; *Sty*, stylus; *T*, tergum; *Vs*, retractile lobe of appendage (retractile vesicle).

retractor muscle (C, D, *rvs*) arising on the dorsum of the segment and inserted by three diverging branches on the distal surfaces of the three terminal lobes of the tubercle. The gill tubercles are thus highly suggestive of the eversible sacs of the thysanuran appendages, except for the difference that their retractor muscles arise on the tergal

region of the body segment, instead of in the bases of the appendages, as in the *Thysanura* (fig. 32 B, *rvs*). On the other hand, as we shall presently see, the gill tubercles of the *Corydalus* larvae are almost identical in structure with the abdominal feet of lepidopterous larvae.

The appendages of the last abdominal segment in the larva of *Chauliodes* and *Corydalus* are remarkable structures in that they combine the characters of the preceding appendages of *Corydalus* with the features of an abdominal leg of a caterpillar. Each of these terminal appendages (figs. 35 D, *Pp*, 36 B, E) consists of a large, hollow, somewhat cylindrical lobe of the body wall. The basal part of the organ (fig. 36 B, E, *LB*) bears laterally a tapering process (*Sty*) similar to the lateral processes of the preceding appendages, and ends distally in a thick tubercle (*Vs*), which lacks gill filaments, but is armed on its terminal surface with a pair of large, curved claws (*d*). The appendage is traversed by a strong retractor muscle (*F*, *rvs*) taking its origin on the dorsum of the tenth segment, and having its insertion on the distal wall of the tubercle at the posterior ends of the long bases of the claws (*e*). The resemblance in structure and mechanism of these appendages to the "anal" legs of caterpillars is so striking that it is difficult to believe the likeness is fortuitous. The terminal body segment is better developed in the *Corydalus* larva (fig. 36 B, *X*) than in *Chauliodes* (fig. 35 E), in which its dorsal part is rudimentary.

Lateral appendicular processes of the abdomen, similar in every respect to those of the sialid larvae, are present also on certain aquatic coleopterous larvae, especially in the families Dytiscidae and Gyrinidae. In the gyrenid *Dincutes*, for example, the larva is provided with long, tapering processes arising from lateral lobes of the body wall on each side of each of the first eight segments, and with a pair of two-branched processes on the ninth segment. Each process is penetrated by a trachea from the lateral respiratory trunk, and is furnished with two short, antagonistic muscles arising in the supporting lobe of the body and inserted on its base. The larva of the dytiscid *Coptotomus* has the same equipment of lateral processes, but the writer did not find muscles connected with them in a specimen examined.

THE ABDOMINAL LEGS OF LEPIDOPTEROUS LARVAE

A typical abdominal leg of a caterpillar consists of three parts (fig. 37 A). At the base is a ring of flexible integument (*mb*); beyond this is a longer, cylindrical section (*Cx*) forming the greater part of the appendage, and frequently having a sclerotic plate in its outer

wall often marked by distinctive groups of setae (fig. 3 A); distally the leg ends in a retractile lobe (*Vs*), called the *planta*, which bears the claws, or *crochets* (*d*).

Functionally the *planta* is the most important part of the leg, and structurally it is the most variable. The proximal parts of the appendage differ principally in relative size in different species. The *planta* in its more generalized condition is a short cylindrical pad with a circular distal surface, on the center of which is inserted a group

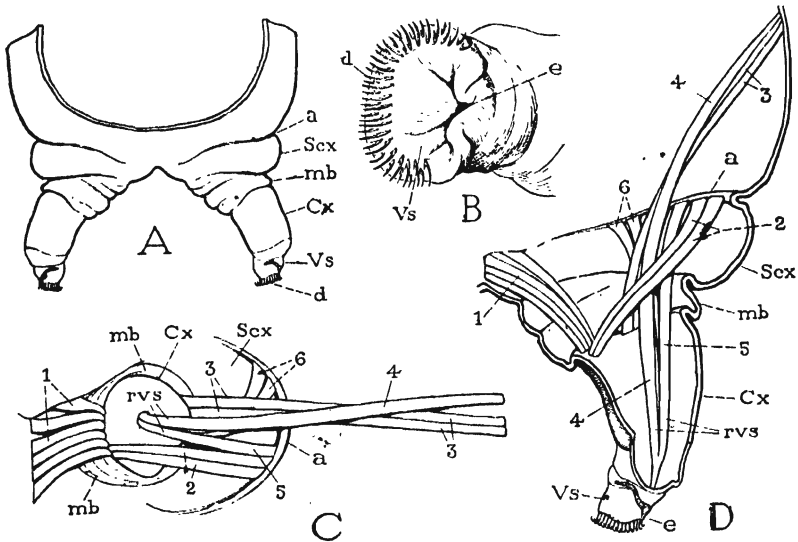

FIG. 37.—Structure of an abdominal leg of a caterpillar. *Malacosoma americana*.

A, posterior view of a pair of abdominal legs. B, ventral view of a left abdominal leg, showing crochets (*d*) turned outward, and insertion of retractor muscles (*e*) at inner margin of plantar lobe (*Vs*). C, dorsal view of leg musculature, right side. D, posterior view of musculature of a right leg.

a, dorso-pleural groove; *Cx*, coxa; *d*, crochets; *e*, insertion point of retractor muscles of planta; *mb*, membranous area between subcoxa and coxa; *rvs*, retractor muscles of planta; *Scx*, subcoxa; *Vs*, planta (retractile vesicle).

of retractor muscle fibers. In such cases the crochets may be arranged in a complete circle around the distal plantar surface, with their recurved points turned peripherally and upward. With most caterpillars, however, the claws are limited to a semicircle or a small arc usually on the inner margin of the planta (fig. 37 B), and in such cases the *planta* itself (*Vs*) generally becomes asymmetrical by a reduction or obliteration of its outer half. The *planta* then assumes the form of a lobe projecting to the mesal side of the axis of the limb, marked by the insertion point of the retractor muscle (*e*), and its claws (*d*)

curve mesally and upward when the planta is protracted in the usual position. The various types of foot structures resulting from modifications in the form of the planta and in the arrangement of the crochets characteristic of the different groups of caterpillars have been described by Fracker (1915).

Immediately above each abdominal leg there is usually a prominent lobe or swelling of the body wall (fig. 37 A, *Scx*), separated from the latero-dorsal area of the segment by a distinct groove (*a*). Corresponding lobes are present also on the legless abdominal segments, and likewise on the metathorax and mesothorax (fig. 3 A, *Scx*). The serial identity of these suprapedal lobes of the abdomen and thorax is demonstrated by their uniform position relative to the appendages, and by the fact that in many species they bear similar or identical marks or groups of setae. In the anatomy of the caterpillar, therefore, the abdominal and thoracic appendages appear to be homodynamous structures. Eastham (1930), in his study of the embryology of *Pieris rapae*, says: "The prolegs which are retained on their segments must be regarded as true appendages. They develop in the same manner as those of the head and thorax, have the same relation to their own somites, and a musculature develops in connection with each comparable to that of the thoracic limbs though of a weaker order."

The suprapedal lobes of the caterpillar (fig. 3 A, *Scx*) are clearly the subcoxal areas of the appendages, since those of the thorax are identical with the areas which in certain other holometabolous larvae contain the pleural sclerites of the thorax (B, C, *Scx*₃). The free part of the abdominal appendage in the caterpillar is, therefore, apparently the coxa (fig. 37 A, *Cx*). The planta (*Vs*), then, is either a rudiment of the telopodite, or a highly specialized retractile vesicle of the coxa. Further light on the morphology of the caterpillar proleg may be obtained from a study of the musculature.

The musculature of an abdominal leg of a caterpillar is comparatively simple. It comprises two sets of muscles, those of one set being inserted on the base of the principal part of the leg (fig. 37 D, *Cx*), those of the other on the planta (*Vs*). The muscles inserted on the proximal rim of the leg include three groups of fibers represented in *Malacosoma americana* and *Estigmene acrea* as follows: (1) a series of median fibers (fig. 21 B, 37 C, D, 1) arising on the midline of the venter, or also on the mesal parts of the anterior and posterior intersegmental folds, and converging to the mesal rim of the base of the principal segment (*Cx*) of the leg; (2) a group of two fibers (fig. 37 C, D, 2) arising on the groove (*a*) above the suprapedal lobe of the body wall, and inserted on the mesal rim of the leg base posteriorly

just ventrad of the insertions of the median muscles; (3) a group of two or three fibers (C, D, 3) taking their origins on the middle of the lateral wall of the segment posterior to and a little above the level of the spiracle (fig. 21 B), and having their insertions on the outer side of the proximal rim of the leg (figs. 21 B, 37 C, D, 3).

The muscles of the planta take their origins outside the leg from two widely separated parts of the body wall. The plantar muscles of *Malacosoma americana* (fig. 37 C, D) comprise four fibers. The principal one is a long fiber (4) arising on the middle of the lateral wall of the segment, close to the origins of the lateral muscles of the leg (3), from which point it curves downward into the leg to be inserted on the inner face of the planta. The other plantar muscles arise on the dorso-pleural groove (a) above the suprapedal lobe (fig. 37 D, *Scx*). One consists of a single fiber (C, D, 5) arising posteriorly just before 2, and entering the leg with 4. The other includes two fibers (6) in *Malacosoma*, represented by a single fiber in *Estigmene* (fig. 21 B, 6), arising anteriorly on the dorso-pleural groove, and curving posteriorly and downward into the leg to join with 4 and 5. In the distal part of the leg (fig. 37 D) all the fibers of the plantar group unite to form a common stalk which is inserted on the inner surface of the ventral wall of the planta. In caterpillars having a disk-shaped planta, the muscle insertion is at or near the center of the latter, but with species in which the planta has the form of a mesal lobe, the muscle attachment is at the outer side of the plantar lobe (fig. 37 B, D, e).

On comparing, in the caterpillar, the musculature of an abdominal leg with that of a thoracic leg, it is found that though there is no exact correspondence in the number and arrangement of the fibers, there is a general similarity in the disposition of the muscles sufficient to suggest a derivation of the muscles in the two cases from one fundamental plan of musculature. Thus, in the metathorax of *Malacosoma* (fig. 38 A, B) there is a set of sternal fibers (a) arising anteriorly on the intersegmental fold, and inserted mesally on the rim of the coxa (*Cx*), which correspond with the median muscles of an abdominal leg (fig. 37 C, D, 1). Likewise, there are muscles from the lateral wall of the thoracic segment inserted on the outer rim of the coxa (fig. 38 B, C, b), having thus the same relation to the appendage as the fibers of muscle 3 in the abdomen (fig. 37 C, D). In the thorax there are several subcoxo-coxal muscles (fig. 38 B, c) which have no exact counterparts in the abdomen, though in the latter there is a muscle from the groove above the subcoxal lobe (fig. 37 C, D, 2) to the inner margin of the apparent coxal segment of the leg. The

other muscles in the base of a thoracic leg (fig. 38 B, C, *d, e, f, g*) are coxo-trochanteral and coxo-femoral muscles, representatives of which are entirely absent in the abdominal legs. On the other hand, the plantar muscles of the abdomen have no evident counterparts in the thorax.

The general parallelism between the muscles of the abdominal appendages and those of the thoracic legs shows that the musculature of the prolegs in the mature caterpillar is, as Eastham says of the musculature in the embryo, "comparable to that of the thoracic limbs though of a weaker order." Moreover, if the musculature has any

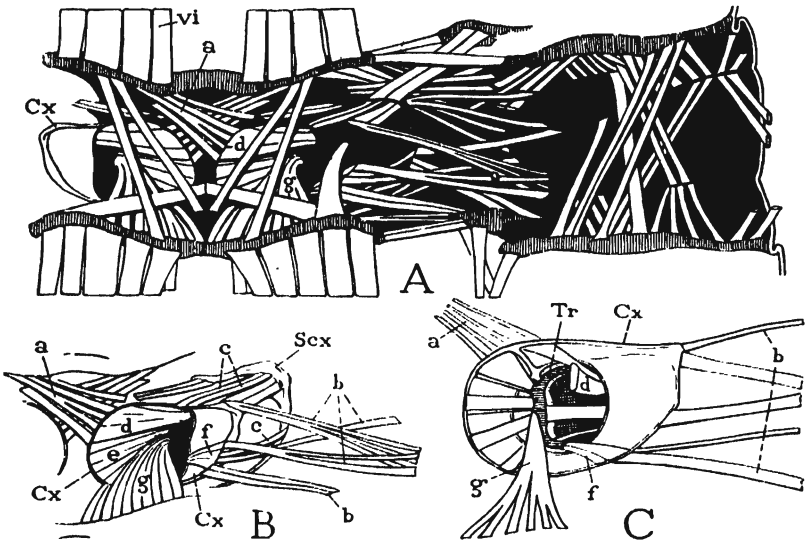

FIG. 38.—Body muscles of a thoracic leg of a caterpillar.

A, external body muscles and leg muscles of ventral area and right half of metathorax of *Malacosoma americana*. B, basal muscles of right metathoracic leg of same. C, coxal and coxo-trochanteral muscles of right mesothoracic leg of *Estigmene acrea*.

bearing on homologies in the segments of the appendages, it shows that the suprapedal lobes of the body wall above the abdominal limbs are the subcoxae (fig. 37 A, D, *Scx*), and that the principal parts of the legs are the coxae (*Cx*). The plantae of the abdominal appendages, however, have no evident homologues in the thoracic legs, nor do their muscles correspond with any of the muscles of the legs in the thorax.

The nature of the planta becomes clear when we compare an abdominal limb of a caterpillar (fig. 37 D) with an abdominal appendage of the *Corydalus* larva (fig. 36 C, D). A striking resemblance is

seen at once between the retractile planta of the former and the gill-bearing tubercle (*Vs*) of the latter. Moreover, the likeness amounts almost to a structural identity when the planta is compared with the claw-bearing lobe of one of the terminal appendages of the *Corydalus* larva (fig. 36 E, *Vs*). In each case the organ is provided with strong retractor muscles arising on the dorsum of the body segment. It is a mere detail that the muscles in *Corydalus* (fig. 36 D, *rus*) branch to the several lobes of the gill tubercle; in the terminal appendages the bundle of retractor fibers (F, *rus*) tapers to a narrow stalk inserted at the bases of the claws exactly as in the foot of the caterpillar (fig. 37 D). The *Corydalus* larva lacks only the accessory muscles of the planta arising in the base of the subcoxa. We can, therefore, scarcely avoid the conclusion that the planta of the caterpillar's abdominal leg is an eversible vesicle of the limb basis, here borne by the coxa, which is not consolidated with the subcoxa. The representatives of the styli, preserved in the movable distal processes of the sialid appendages (fig. 36 C, D, E, *Sty*), have been lost from the abdominal limbs of all lepidopterous larvae.

The anal legs, or appendages of the last abdominal segment of the caterpillar, differ from the legs of the preceding abdominal segments only in details of their musculature. Their structure will be described in the subsequent discussion of the terminal appendages of holometabolous larvae.

The abdominal appendages of chalcidogastrous hymenopterous larvae have the same essential structure as the abdominal limbs of caterpillars, though they are not so highly organized, and the plantar lobes are reduced to terminal disks of the coxal segments (fig. 3 C).

THE GONOPODS

The appendages of the eighth and ninth segments of the abdomen are potentially gonopods because of the association of the openings of the genital ducts with these segments. They are, however, not necessarily modified for reproductive purposes, as in the males of certain Thysanura in which the appendages of the eighth and ninth segments (fig. 33 C) do not differ structurally from those of the preceding segments.

Typically a gonopod is distinguished from the pregenital and postgenital appendages by the development of a median process from the proximal part of its base. A complete gonopod, therefore, consists of a *basal lobe* or *plate* (fig. 31 B, *LB*), of a lateral, distal *stylus* (*Sty*), and of a median, proximal *gonapophysis* (*Gon*). Both the stylus and

the gonapophysis may be movable on the basis by muscles arising in the latter and inserted on their bases (*smcls*, *gmcls*). So far as has been ascertained neither of the appendicular parts of a gonopod ever contains intrinsic muscles. In the males of some Ephemera the genital styli are distinctly jointed and thus separated into apparent segments, though the latter are not independently movable. In the Thysanura the gonapophyses are marked by circular constrictions, varying from a few to many according to the length of the organs (fig. 33 A, B), but the resulting subdivisions have none of the characters of true segments, and are entirely comparable with the annulations of the caudal filament and cerci (C; cf, *Cer*).

In female insects the gonopods form the ovipositor, when this organ is present, and both pairs of appendages enter into its composition. In the Thysanura the gonapophyses only are involved in the ovipositor, the basal plates and the styli retaining the structure typical of these parts in the pregenital segments of Machilidae. Evidently the condition here represents a primitive stage, in which two pairs of median apophyses of the appendages of the eighth and ninth abdominal segments form a simple egg-laying organ. In female Pterygota the styli of the gonopods are usually lost, those of the first pair being always absent, and the basal plates are transformed into a suspensory apparatus for the gonapophyses. The basal plates of the first gonopods (fig. 39 A) evidently become the small sclerites known as the valvifers (B, *Vlf*), which support the first gonapophyses (*1VI*), though there is a difference of opinion on this point. Those of the second gonopods form lobes (*IXLB*) supporting the second gonapophyses (*2VI*), or they are drawn out into long processes that become a third pair of blades in the ovipositor (C, *3VI*). The component blades of the adult ovipositor are commonly called *valvulae*. It is to be observed that only the first and second pairs of valvulae (B, C, *1VI*, *2VI*) represent the gonapophyses (A, *1Gon*, *2Gon*), those of the third pair (C, *3VI*) being derived directly from the basal plates of the second gonopods, the styli of which are apparently lost.

The ovipositor is absent or rudimentary in many groups of insects, but its wide distribution throughout the orders leaves little doubt of its being a primitive structure of the Insecta. It has no homologue in other Arthropoda, and it is doubtful if the rami of the gonopods in the Crustacea are homodynamous with the gonapophyses of insects. The various theories concerning the possible homologies of the genital processes of the gonopods in insects will be considered in the closing discussion of this paper.

In male insects the history of the gonopods is much more involved than in the female, and the evolution of the genital appendages into organs of copulation has produced many different kinds of structures. It is only in certain species of *Machilis* that both pairs of gono-

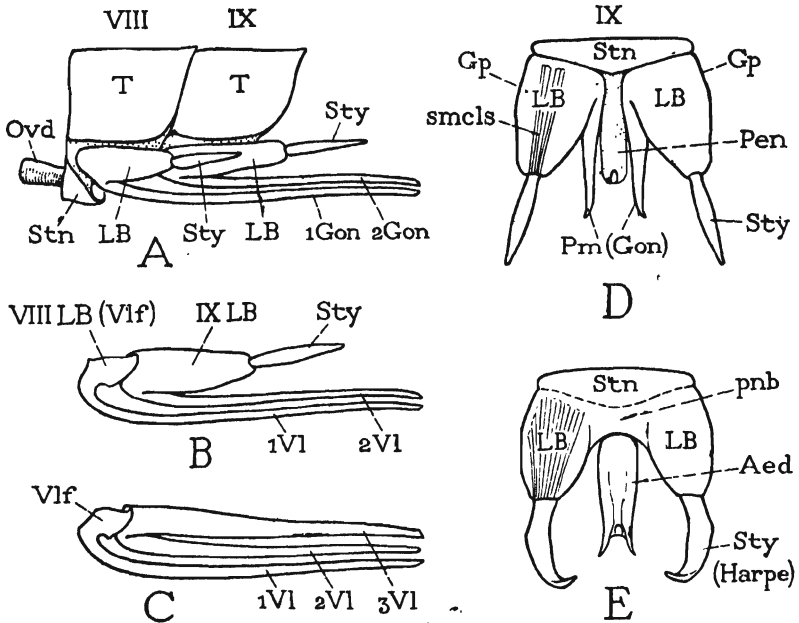

FIG. 39.—Diagrams showing the morphology of the ovipositor, and the external genitalia of the male.

A, female genital segments and generalized structure of the gonopods. B, an ovipositor with two pairs of valvulae formed of the gonapophyses. C, an ovipositor with three pairs of valvulae, the third pair (3VI) formed of the basal plates of second pair of gonopods (A, LB).

D, generalized structure of ventral parts of ninth abdominal segment of male, showing sternum (Stn), gonopods (Gp, Gp), and penis (Pen). E, specialized structure of male genitalia; basal plates of gonopods (LB, LB) united by pons basalis (pnb), parameres united with penis to form an aedeagus (Aed), and styli (Sty) transformed into clasping lobes.

Aed, aedeagus; Gon, gonapophysis; 1Gon, 2Gon, gonapophyses of first and second gonopods; LB, basal plate of gonopod; Ovd, oviduct; Pm, parameres (male gonapophyses); pnb, pons basalis; smcls, muscles of stylus; Stn, sternum; Sty, stylus; T, tergum, 1VI, 2VI, 3VI, first, second and third valvulae; Vlf, valvifer.

pods bear gonapophyses (fig. 33 A, B, 1Gon, 2Gon). In all male pterygote insects gonapophyses are lacking on the eighth segment, and the gonopods of the ninth segment only enter into the copulatory apparatus, though accessory structures of the eighth and the tenth segment may be included.

The basal plates of the second gonopods in the male may unite with each other and with the primary sternum of their segment, as do those of the preceding segments, to form a composite zygosternum, and in such cases the styli either retain the typical shape of styliform organs, or they are lost. The gonapophyses, usually termed the *parameres*, however, in the more generalized insects, are associated with a median intromittent organ, or penis (figs. 33 B, 39 D, *Pen*), which is a tubular evagination of the segmental wall behind the ninth sternum, bearing the opening of the ejaculatory duct at its extremity. In the higher insects the primitive penis becomes partly or entirely suppressed, and the parameres unite with it or with each other to form the secondary and often more complicated intromittent organ usually termed the *aedeagus* (fig. 39 E, *Aed*), which incloses the ejaculatory duct and bears the gonopore.

The basal plates of the gonopods of the ninth segment in the male, if not completely amalgamated with the sternum, may form free lobes of the ninth segment, or they may unite with each other, with the sternum, or with the sternum and the tergum of the ninth segment. In this way the genital segment of the male, especially in holometabolous insects, assumes a great diversity of structure, and it is often reduced to a simple continuously sclerotized annulus. The ninth segment, however, regardless of its form, always bears the *aedeagus*, which may be partly or wholly concealed in a *genital chamber* of its ventral part, and it generally carries clasping organs of various forms on its posterior margin. Usually, among the clasping organs of the ninth segment, or often the only structures having a clasping function, is a pair of lobes flexible at their bases and independently movable by muscles taking their origins in the basal plates of the gonopods, or in the regions of the ninth annulus derived from the gonopod bases. These movable claspers, designated the *harpes* by students of Lepidoptera, are evidently the homologues of the styli of the more generalized insects (fig. 39 D, E, *Sty*).

It is most important, now, to observe that in the fundamental organization of the gonopods there are only two sets of appendicular structures that are independently movable by muscles inserted directly on their bases. These structures are the styli and the gonapophyses. Therefore, in the ninth segment complex of the male genitalia, there will generally be two sets of appendicular structures, the *harpes* and the *parameres*, provided with muscles arising in the basal plates of the gonopods, or in the parts of the ninth segmental ring derived from the latter. By a study of the genital musculature, then, these two structures can be identified with certainty in almost all cases

throughout the orders, unless one or the other or both are absent. In addition to these fundamental, muscled processes, however, there are innumerable other secondary genital processes having no necessary homology in the different orders, which may be developed on the ninth segment, on the aedeagus, or on the segments preceding and following the ninth. These structures, except in rare cases, have no muscles of their own, and are not independently movable, though some of them may be moved incidentally by the usual segmental muscles attached at their bases. The movable claspers derived from the styli, however, are sometimes divided, and each may be separated into two quite distinct parts provided individually with groups of muscle fibers. In such cases there will appear to be, as in some of the Hymenoptera, a pair of movable lobes on each side of the genital apparatus.

A more detailed analysis of the structure of the organs of oviposition and copulation, as shown in the principal orders of insects, will form the subject matter of Part II of this paper, wherein will be presented also a larger body of evidence in support of some of the statements that seem arbitrary in the brief discussion given above.

THE CERCI (UROPODS)

The prevalence of cerci in so many orders of insects, and the almost universal occurrence of the organs in the more generalized groups leave little doubt that the cercal appendages are primitive structures, and that, in some form, they must have been characteristic features of the early insect ancestors. The anatomy and structural variations of the cerci are well known; functionally the appendages are in most cases sensory organs, though they are frequently modified in form to serve mechanical purposes; morphologically they are subjects of diverse opinion among speculative entomologists. The essential facts known concerning the cerci can be briefly stated.

In the Thysanura the cerci evidently belong to the eleventh abdominal segment. The last typical segment of the body in such forms as *Nesomachilis* (fig. 7 A) is the tenth (X), which is a complete annulus. From within the posterior margin of this segment there project the three terminal filaments, of which the lateral pair are the cerci (*Cer*). If the group of filaments is pulled out of the tenth segment, it is seen that the three of them arise from a common basal ring (B, XI), which has all the aspects of a reduced segment, in this case the eleventh, normally concealed within the tenth. The eleventh annulus presents a wide dorsal region (C, XIT) prolonged into the

median caudal filament (*cf*), a narrow ventral region (*D*, *XISin*) bearing a pair of broad posterior flaps (*Papt*), and two prominent lateral lobes supporting the cerci (*Cer*). There can be little doubt, therefore, that the caudal filament and the cerci here belong to the eleventh abdominal segment. The lobes of the eleventh sternum are evidently the paraprocts (*D*, *Papt*). Projecting from beneath the base of the caudal filament (*D*, *cf*) is a small median lobe (*sa*), possibly a remnant of the true telson, represented by the lamina supra-analis of the twelfth segment, better developed in odonate larvae (fig. 12 A, *sa*).

The terminal parts of the abdomen are less simple in some other thysanurans than they are in *Nesomachilis*. In *Thermobia* (fig. 7 E, F), for example, the eleventh segment is largely obliterated except for a distinct tergal plate, or epiproct (*E*, *Eppt*), which is connected

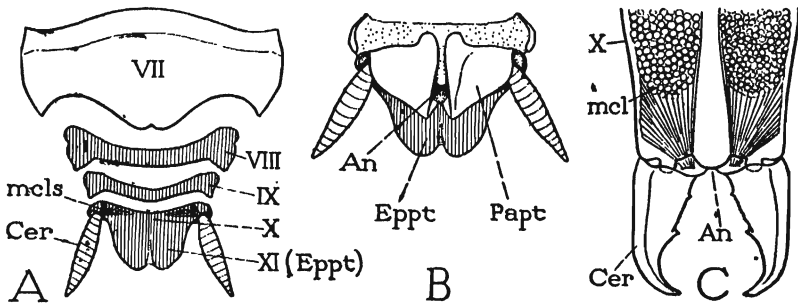

FIG. 40.—The cerci and associated parts.

A, posterior segments of *Periplaneta orientalis*, dorsal view, showing union of tenth and eleventh abdominal terga. B, ventral view of terminal segment of same. C, cerci of *Heterojapyx gallardi*, and muscles of tenth segment that move them.

laterally by a pair of small sclerites with the bases of the cerci (*Cer*). The paraprocts of *Thermobia* are large sclerotic plates (*F*, *Papt*) supporting the cerci. They would thus appear to correspond with the lateral lobes of the eleventh segment and the median paraproct plates of *Nesomachilis* (*D*). A sternal region of the eleventh segment distinct from the paraprocts is not evident in *Thermobia*.

In the *Dicellura* (*Campodeidae* and *Japygidae*) the abdominal segments beyond the tenth are obliterated, and the cerci are supported directly by the end of the tenth segment (fig. 40 C, *Cer*).

The cerci of the *Pterygota* most commonly appear to belong to the tenth abdominal segment, since they arise at the posterior edge of the latter, usually from membranous areas inclosed by the adjacent angles of the tenth tergum, the epiproct, and the paraprocts (fig. 12 A, B, *Cer*). In *Periplaneta* the cerci of the adult insect arise from be-

tween the lateral angles of the last tergal plate and the upper angles of the paraprocts (fig. 40 A, B), but the terminal plate of the dorsum is here clearly a composite sclerite formed of the united tenth tergum (A, X) and the epiproct (XI). Frequently the cerci are more closely associated with the paraprocts than with the tergal plates. In any case, however, the intermediate position of the cerci in adult Pterygota gives no positive evidence of the segmental relations of these appendages in this group of insects.

On the other hand, the ontogenetic evidence of the nature of the pterygote cerci seems to be quite definite, for it is stated by Ayers (1884), Cholodkowsky (1891), Wheeler (1893), and Heymons (1896a) that the cerci in the embryos of Orthoptera are formed directly from the appendages of the eleventh abdominal segment (figs. 5 A, 9 A, B, *Cer*). Heymons claims that the eleventh segment itself disappears from the adult abdomen, and that the cerci thus come to have an apparent intersegmental position between the tenth and the twelfth segments. As already shown, however, it appears more probable that the eleventh segment is usually represented in the adult by the epiproct and the paraprocts, and that it is the twelfth segment which is lacking, or reduced to a circumanal fold (fig. 12 A, *Prpt*).

The association of the cerci with the upper basal angles of the paraprocts, or their actual connection with these plates in some cases, as in *Thermobia* (fig. 7 F), has given rise to the idea that the cerci and the paraprocts have a genetic relation to each other. Thus, Crampton (1920, 1921) contends that the paraproct is the base of a segmental appendage of which the cercus is the distal part. According to Heymons (1896), on the other hand, the embryonic cercus represents the *entire* appendage of the eleventh segment, including the basis, which in the pregenital segments unites with the primary segmental sternum to become a lateral part of the definitive sternal plate. In the adult insect, Heymons says, the cercal base usually disappears as an evident lobe, though a rudiment of it is retained in young nymphs of *Gryllus* and *Decticus* as a small basal ring supporting the free part of the organ (fig. 8 B).

The musculature of the cerci, so far as it is known, is always dorsal, there being no muscles from the sternal region of the abdomen or from the paraprocts in any way associated with the cerci. The origins of the muscles present, however, give no clew to the segmental relations of the cerci, since the muscles arise either on both the tenth and eleventh terga, or on the tenth tergum alone. In her study of the abdominal muscles of Orthoptera, Ford (1923) finds that each cercus is typically

provided with four muscles. Three of these muscles, distinguished as an abductor, a depressor, and an elevator muscle, take their origins on the tenth abdominal tergum; the fourth arises on the supra-anal plate or epiproct. The muscle from the epiproct, Ford says, is absent in *Gryllotalpa*, but it is present in *Gryllus*, *Neoconocephalus*, *Ceuthophilus*, and *Melanoplus*. In *Gryllus*, because of the union of the tenth tergum and the epiproct, this muscle, however, has shifted forward to the area of the tenth tergum. The writer has found only three muscles in *Dissosteira* inserted directly on the base of the cercus, two arising on the tenth tergum, and one on the epiproct.

The origin of the anterior muscles of the cerci on the tenth segment might be construed as evidence in favor of the view that the cercal appendages belong to the tenth segment; or, on the other hand, it might be taken as favoring Heymons' claim that the true eleventh segment has been obliterated. However, it is not necessary to assume that the muscles associated with the cerci are primarily muscles of these appendages. The great bundles of fibers that operate the pincer-like cerci of *Japyx* almost fill the large tenth abdominal segment (fig. 40 C, *mcl*), but they appear to be the longitudinal dorsal muscles normal to this segment, which secondarily function as cercal muscles by reason of their posterior attachments at the bases of the cerci. Ford (1923), observing that most of the cercal muscles in Orthoptera arise from the tenth tergum, asserts that these muscles are "intersegmental muscles between the tenth and eleventh segments," while the muscles from the epiproct, she says, represent "the intersegmental muscles between the eleventh and twelfth terga." (Her reference of the posterior muscles to the twelfth tergum is in accord with her acceptance of Heymons' claim that the eleventh segment has disappeared in the adult.)

Whatever may be the nature of the dorsal muscles of the cerci, the fact is significant that the organs have no ventral musculature—in this respect cerci differ from styli and gonapophyses. The absence of muscles from the paraprocts to the cerci, moreover, weakens the comparison between the paraprocts and the stylus-bearing plates of the preceding abdominal segments, since the stylus muscles always take their origin in these plates. The termination of the ventral musculature of the abdomen in the paraprocts, on the other hand, makes it almost certain that the paraprocts are terminal lobes of the eleventh sternum.

Cerci are usually absent in holometabolous insects, but cercus-like appendages occur on the eleventh abdominal segment in females of *Panorpa* (fig. 8 H, *Cer?*), and on the terminal segment of adult

Tenthredinidae, which is numerically the tenth abdominal segment. The panorpid appendages may be true cerci. Appendages occurring on an apparent tenth segment might be suspected of being cerci if there is evidence that this segment is composed of the tenth and eleventh somites, a condition which frequently occurs in orthopteroid insects, where there is no doubt that the terminal appendages are the cerci. In the Tenthredinidae, however, there is reason to believe, as will be shown later, that the terminal appendages of the adult are not the cerci, but are appendicular organs of the tenth segment corresponding with the *socii* of adult Lepidoptera, and that they are derived from the postpedes of the tenth somite of the larva.

THE TERMINAL APPENDAGES OF ENDOPTERYGOTE LARVAE

Appendicular organs representative of abdominal limbs are present on the last abdominal segment in some or most of the larvae of Neuroptera, Trichoptera, Lepidoptera, and chalcidogastrous Hymenoptera. These larval appendages of the terminal segment have a lateral or latero-ventral position, and are movable by muscles in some cases attached on their bases, but more generally inserted within their distal parts. The appendages most resemble jointed limbs in the Trichoptera. In Neuroptera, Lepidoptera, and Hymenoptera they commonly have the structure typical of the abdominal legs of the caterpillars. Since the terminal segment in these larvae is evidently the true tenth somite of the abdomen, or the tenth and the eleventh somites combined, there is little doubt that the terminal appendages are the pygopods. The Endopterygota differ thus from the more generalized Exopterygota in that some of them retain the tenth segment appendages in postembryonic stages.

In addition to the true appendicular organs, there may be in endopterygote larvae also processes developed from the dorsum of the last segment, and lobes of various forms associated with the anal opening, or protruded from within the rectum. Processes resembling cerci occur in some coleopterous larvae, but their morphology is uncertain.

It seems probable that the pygopods of endopterygote larvae are, in certain orders, carried over to the adult stage as processes which sometimes occur on the proctiger, or terminal segment of the imago. These processes have various forms in the Trichoptera and Lepidoptera, and are termed the *socii* by students of the latter; in chalcidogastrous Hymenoptera they resemble cerci, and are frequently called "cerci." Busck and Heinrich (1922) have observed that in the microlepidopteron *Ethmia machelosiella* the anal prolegs, with their

crochets, are retained in the pupa, and Bottimer (1926, fig. 3 A) shows a similar retention of the anal legs in the pupa of *Chaetocampa crotoneilla*. It is unfortunate that socii are absent in these species, for we might expect to find the socii developed within the anal prolegs of the pupae. More positive evidence of the identity of the terminal larval appendages with the terminal appendages of the adult is presented by Middleton (1921) in a study of the chalastogastrous Hymenoptera. Middleton claims that the anal prolegs, or postpedes, of the larva of *Pteronidea ribesii* are transformed during metamorphosis into anal lobes of the pupa, and that within these lobes are developed the so-called "cerci" of the adult sawfly. These appendages of the adult insect, he points out, are not borne by the tergum of the anal segment, but arise from a lateral membranous area of the venter of this segment, and thus morphologically have the same position as have the postpedes of the larva. The anal segment in both the larval and the adult sawfly is numerically the tenth abdominal segment, and its appendages are therefore not the true cerci in either case.

Trichoptera.—The abdomen of trichopterous larvae lacks appendages except on the terminal segment. In some forms, as in *Platyphylax designatus*, a fringe of slender setae along each side of the abdomen from the second to the end of the eighth segment (fig. 41 A, B, a) evidently marks the dorso-pleural line separating the dorsum of the abdomen from the region of the limb bases (LB), since, if the line of this fringe were carried into the thorax, it would run dorsad of the thoracic subcoxae (A, *Scx*₃). On the ninth segment there is nothing to mark the dorso-pleural boundary; but on the terminal segment the base of the appendage (B, *Pp*) has a lateral position corresponding with the limb base areas of the segments preceding the ninth. The terminal segment of *Platyphylax* is a hemispherical lobe with a long, median anal cleft on the ventral part of its distal surface (*An*). It is evidently the tenth somite, or pygidial segment.

The pygopods of trichopterous larvae differ considerably in different families and genera. Their principal variations have been described by Ulmer (1903) and by Krafka (1924). According to Ulmer there are two principal types of these appendages. Those of one type are short; those of the other, characteristic of *Hydropsychidae* and *Rhyacophilinae*, are long and leg-like. In both types the limb terminates in a hook-like claw. The structure of the two forms of appendages is here illustrated from *Platyphylax designatus* (fig. 41 B, *Pp*) and an unidentified species of *Hydropsyche* (F, *Pp*).

In *Platyphylax designatus* each larval pygopod together with its supporting structure (fig. 41 B, *Pp*) consists of a large basal plate (C,

b), a smaller intermediate plate (*c*), and a free apical claw (*d*) having its point turned downward and outward. The apical claw has a movement of adduction on the middle plate, and the latter is movable on its hinge with the basal plate. The muscles of this appendage may be studied by cutting the terminal body segment into lateral halves. It is first seen that the base of the appendage is crossed internally by several slender transverse muscles attached on the segmental walls. The muscles inserted on the appendage consist of three flat groups of

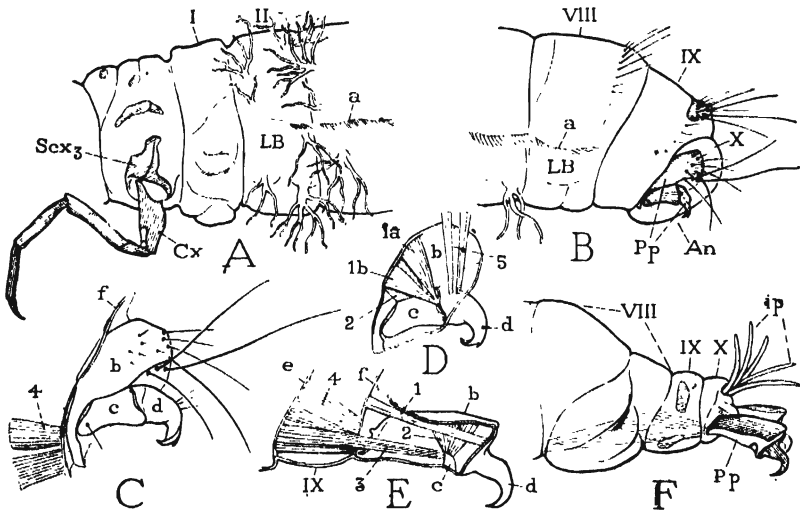

FIG. 41.—Structural details of trichopteran larvae.

A, metathorax and anterior part of abdomen of *Platyphylax designatus*. B, posterior abdominal segments of same. C, appendage of tenth segment of same. D, mesal view of right appendage, showing muscles. E, mesal view of terminal appendage of *Hydropsyche* sp., showing muscles. F, posterior end of abdomen of same, with intestinal processes (*ip*) extruded from anus.

a, line of dorso-pleural groove; *An*, anus; *b*, proximal sclerite of appendage; *Cx*, coxa; *d*, claw of appendage; *e*, *f*, intersegmental folds between eighth and ninth, and ninth and tenth abdominal segments; *ip*, intestinal processes; *LB*, area of abdominal limb base; *Pp*, pygopod; *Scx*, subcoxa.

fibers (fig. 41 D), all arising on the anterior margin of the basal plate (*b*). Two of these muscles (*1a*, *1b*) converge downward and posteriorly to a common point of insertion on the inner margin of the base of the apical claw (*d*), and thus evidently function as adductors of the latter. The third muscle is a broad sheet of fibers (*2*) lying external to the others, and inserted on the dorsal margin of the intermediate plate (*c*). Associated with the appendage is a pair of slender, vertical fibers (*5*) crossing the inner face of the basal plate and attached above and below it to the membranous walls of the

terminal body segment. The ventral muscles of the ninth body segment (C, 4) are attached posteriorly on the intersegmental fold (*f*) just before the lower part of the basal plate of the appendage, but no muscles are inserted directly on the latter.

The terminal appendages of the larva of *Hydropsyche* (fig. 41, F, *Pp*) represent quite a different type of appendicular organ. Each pygopod here is a large, two-segmented, leglike structure projecting from the ventro-lateral part of the terminal body segment. The proximal segment of the appendage (E, *b*) is elongate and cylindrical; the distal segment (*d*) is a strong, decurved claw with a high, narrow base articulated by its dorsal end with the dorsal extremity of the basal segment. Ventrally, just before the base of the claw, there is a small triangular sclerite (*c*) in the lower, membranous wall of the proximal segment.

The musculature of the terminal appendage of *Hydropsyche* (fig. 41 E) differs in several respects from that of *Platyphylax* (D). As in the latter, however, there are no muscles inserted on the base of the organ, but there are an adductor muscle (E, *r*) inserted on the base of the apical claw (*d*), and two flexor muscles (2, 3) inserted on the small ventral sclerite (*c*). The adductor (*r*) arises, not in the basal segment of the appendage as in *Platyphylax* (D, *1a*, *1b*), but in the proximal part of the last body segment. One of the flexor muscles (E, 2) is a broad fan of fibers arising on the dorsal wall of the basal segment, and thus suggests an identity with muscle 2 of *Platyphylax* (D) arising on the basal plate of the appendage. The other flexor muscle is a long bundle of fibers (E, 3) arising on the intersegmental fold (*e*) between the eighth and ninth abdominal segments along with the fibers of the ventral longitudinal muscles of the ninth segment (4), but separating from the latter posteriorly to enter the appendage. This muscle apparently has no representative in *Platyphylax* (D).

The relation between the two types of appendages described above is obscure. The only suggestion that can be made is that the basal plate of the *Platyphylax* appendage (fig. 41 D, *b*) corresponds with the basal segment of the *Hydropsyche* appendage (E, *b*) and that the intermediate plate of the former (*c*) is represented by the small ventral sclerite (*c*) of the latter. The apical claw (*d*) is evidently the same in both. Still more difficult is it to find possible homologies between either of these two types of trichopterous appendages and the terminal appendages of the sialid larvae, *Chauliodes* and *Corydalus* (figs. 35 D, E, 36 B, E), or the abdominal legs of lepidopterous larvae (figs. 37, 42 C). The basal plate or basal segment (*b*) in the tri-

chopterous appendage, however, may be the limb basis of a more typical abdominal appendage, while the apical claw (*d*) and the associated middle plate (*c*) may possibly represent the stylus. Judging from the structure there is little probability that the trichopterous claw is homologous with the claws of *Corydalus* or *Chauliodes*, or with the crochets of lepidopterous larvae. The lack of similarity in the larval abdominal appendages of Trichoptera and Lepidoptera is somewhat surprising, considering the many other structural likenesses between these two orders.

Many trichopterous larvae are provided with a group of slender processes protractile through the anus (fig. 41 F, *ip*), which arise from the intestinal wall. In the species of *Hydropsyche* figured there are from four to six of these processes. The structures are hollow, thin-walled tubules containing no tracheae, and are therefore usually termed "blood gills"; but the idea of their respiratory nature is based on their structure and on the fact that they can be entirely exposed by protraction through the anus, for no one apparently has made any physiological experiments on their function. According to Branch (1922) the organs arise as diverticula of the intestinal wall produced posteriorly from the six folds of the pre-rectal part of the proctodeum, and each is provided with a three-branched muscle taking its origin on the intersegmental membrane between segments VIII and IX of the abdomen, and extending through the lumen to the tip of the processes. When retracted the processes lie in the rectum with only their extremities exposed in the anal aperture. Protraction evidently is accomplished by internal pressure resulting from a contraction of the abdominal walls.

Neuroptera.—The pygidial appendages in the larvae of the sialid genera *Chauliodes* and *Corydalus*, as already noted, are long, thick structures projecting posteriorly and ventrally from the terminal segment of the abdomen (fig. 35 D, E, *Pp*, fig. 36 B, E). Each organ consists of a large basis (fig. 36 E, *LB*), supporting laterally a flexible, tapering process representing the stylus (*Sty*), and bearing distally a short, cylindrical lobe (*Vs*) armed with two strong claws (*d*). The appendage has a striking resemblance to the typical abdominal leg of a caterpillar, except that the latter has no representative of the stylus. The distal lobe, which clearly is serially homologous with the gill-bearing tubercles of the preceding appendages in *Corydalus* (fig. 36 B, C, D, *Vs*), is remarkably like the planta of the caterpillar's leg (fig. 37 D, *Vs*). It is retracted by a strong muscle (fig. 36 F, *rus*) arising on the dorsal wall of the terminal body segment, and inserted on the distal wall of the lobe at the posterior or upper end of the long

bases of the claws. The claws themselves are in every way suggestive of the crochets of the caterpillar's foot.

Notwithstanding the general structural resemblance between the terminal appendages of *Chauliodes* or *Corydalus* and the abdominal legs of caterpillars, it can scarcely be supposed that the foot structure in either case has been derived immediately from that of the other, since the two-clawed condition would be a highly specialized one in the Lepidoptera. All that may be claimed is that the fundamental structure of the larval abdominal limbs is the same in both the Neuroptera and the Lepidoptera. The neuropterous appendage is the more primitive in that it retains the stylus, which has the form of a segmented appendage in *Sialis* (fig. 35 A, C). We may assume that the gill-bearing tubercles of the *Corydalus* larva have been formed secondarily from the foot lobes, or retractile vesicles, as a better adaptation to aquatic life in this genus, and that the vesicles have been lost from all the appendages in *Sialis*, and from all but the terminal appendages in *Chauliodes*.

Lepidoptera.—The so-called anal legs, or postpedes, of caterpillars are so similar to the legs of the preceding abdominal segments as scarcely to need a separate description. The musculature of the two sets of appendages, however, differs in some respects. The plantar lobe of each anal leg is retracted by a large dorsal muscle (fig. 42 A, B, C, *rvsd*) and a small ventral muscle (*rvsv*), both arising from the intersegmental fold (*f*) before the ninth abdominal segment. The lateral muscles of the leg are reduced to a few fibers (D, *b*) lying external to the large dorsal retractor of the planta. Between the bases of the legs there is a sheet of transverse ventral muscles (B, *tv*), which appear to belong to the wall of the last body segment rather than to the appendages.

The great development of the dorsal retractor muscles of the anal legs, the reduction of the lateral muscles, and the presence of the ventral retractors of the plantae are all features correlated with the function of the postpedes in the caterpillar, which usually have a stronger independent forward movement than do the legs of the preceding segments.

The large terminal segment of lepidopterous larvae appears to be a compound segment composed of the tenth abdominal somite, with its appendages, the pygopods, and the reduced eleventh segment, bearing the anus, but lacking cerci. Figures of the embryo of *Pieris rapae* given by Eastham (1930) show clearly a well-developed tenth abdominal segment bearing the last pair of appendages, and beyond it a large terminal lobe, containing the anus, which is evidently the

eleventh somite. In the caterpillar (fig. 11) the eleventh somite is apparently represented in the terminal segment by the four postpedal lobes surrounding the anus (C, D), which may be supposed to be the epiproct (*Eppt*), the paraprocts (*Papt*), and a hypoproct (*Hypt*). There is, however, no evidence of a dual composition of the terminal segment of the caterpillar furnished by the musculature of this segment. Both the dorsal and the ventral internal longitudinal muscles

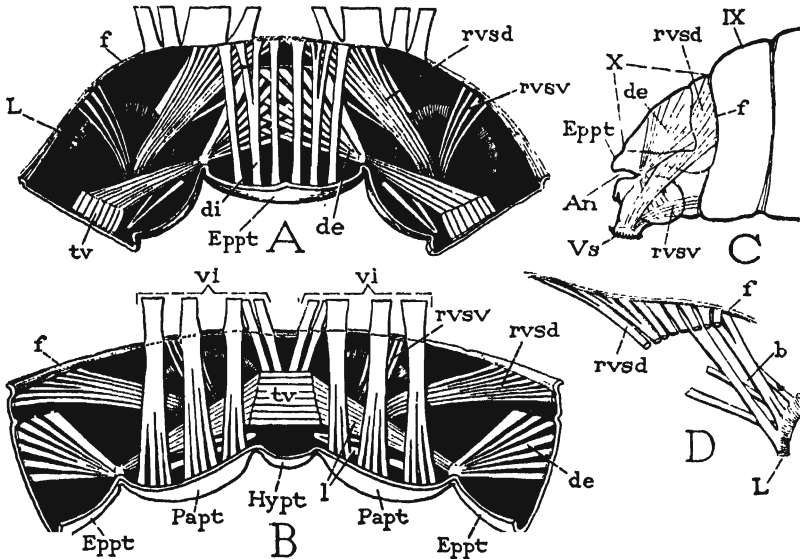

FIG. 42.—Musculature of the terminal segment and pygopods of a noctuid caterpillar.

A, dorsal muscles and leg muscles seen from below in terminal segment cut open along mid-ventral line and spread out. B, ventral musculature of same segment, seen from above. C, posterior end of abdomen, showing origins of leg muscles. D, basal rim of left leg (*L*) and group of small muscles (*b*) lying beneath dorsal retractors of planta (*rvsd*).

An, anus; *b*, group of small antero-lateral leg muscles; *de*, external dorsal muscles; *di*, internal dorsal muscles; *Eppt*, epiproct; *f*, intersegmental fold between ninth and tenth segments; *Hypt*, hypoproct; *L*, basal rim of leg; *l*, lateral muscles; *Papt*, paraproct; *rvsd*, dorsal retractor of planta; *rvsv*, ventral retractor of planta; *tv*, transverse ventral muscles; *vi*, internal ventral muscles; *Vs*, planta.

(fig. 42 A, B, *di*, *vi*) extend continuously from the anterior intersegmental fold (*f*) to the epiproct and the paraprocts. Two large sets of internal dorsal fibers (A, *de*) arise in the notches between the epiproct and paraprocts and are inserted on the dorsal plate of the segment. The eleventh segment, therefore, if represented here at all, is reduced to the circumanal lobes; and the fibers of the longitudinal muscles of the tenth and eleventh segments have become continuous.

Continuity of muscle fibers is of frequent occurrence wherever the intersegmental connections are lost, or where segmental boundaries are obliterated.

Chalastogastrous Hymenoptera.—The larvae of the sawflies and horntails are provided with terminal appendicular organs of several varieties, all borne by the last abdominal segment, some arising from the dorsum, others from the venter.

On the dorsum there is in some forms, as in *Pteronidea ribesii* (fig. 43 A), a pair of small, immovable lateral processes (*a*) arising from the end of the last segment above the anal opening (*An*). These processes have been regarded as rudimentary cerci (Crampton, 1919), but they are more evidently mere cuticular outgrowths, as claimed by Middleton (1921), analogous with the urogomphi of coleopterous larvae (fig. 44 C, *ug*), since they have none of the characteristics of

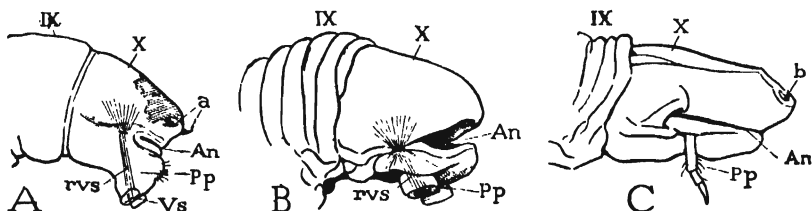

FIG. 43.—Terminal appendicular structures of larvae of chalastogastrous Hymenoptera.

A, *Pteronidea ribesii* (Tenthredinidae). B, *Cimbex americana* (Cimbricidae). C, *Cephaleis* sp. (Pamphiliidae).

a, paired processes of dorsum of terminal segment; *An*, anus; *b*, median process of dorsum of terminal segment; *Pp*, postpedes, or pygopods; *rvs*, retractor muscle of plantar lobe; *Vs*, planta.

true cerci, and, according to Middleton, take no part in the formation of the lateral, cercus-like appendages of adult Tenthredinidae. In certain other chalastogastrous larvae a median process, or postcornu (fig. 43 C, *b*), is borne on the end of the tenth abdominal segment. This process varies characteristically in shape and size in different families, as tabulated by Middleton (1921). It occurs in larvae that bore into stems or that live in silk-spun tents or within the hollow of curled leaves.

The ventral appendages of the pygidial segment of chalastogastrous larvae likewise vary in form in different groups. Those of species that live in the open closely resemble the anal legs of lepidopterous larvae. In *Pteronidea ribesii*, for example (fig. 43 A), a ventral projection of the tenth segment beneath the anus, bearing two small terminal lobes (*Vs*), is clearly the homologue of a pair of appendages

such as occur on the more anterior segments of the abdomen. The free lobes (*Vs*) are evidently comparable with the plantae of the abdominal legs of caterpillars (fig. 37 D, *Vs*), though the retractor muscles of the lobes in the sawfly larva take their origins from a point on the side of the segment just anterior to the cleft of the anal opening (fig. 43 A, *rvs*). In other forms, as in *Cimbex americana* (B), the ventral appendages (*Pp*) consist apparently of the plantar lobes only, which arise directly from the flattened venter of the pygidial segment. Again, as in the Cephidae and Pamphiliidae, typical "prolegs" are replaced on the tenth segment by slender jointed appendages (C, *Pp*); but these "arthrostyli," as they have been called (Crampton, 1919), are evidently alternative forms of the anal "prolegs," or postpedes, since they arise at approximately the same points as do the typical postpedes in other forms (A, *Pp*), and do not occur conjointly with the latter. They are not, however, provided with muscles, so far as the writer could discover; but each is penetrated by a large nerve, and bears sense organs on the distal segment having the form of minute disks, in addition to setae on the proximal and middle segments. The jointed form of the terminal appendage is, therefore, evidently an adaptation to a sensory function instead of a locomotory one.

Crampton (1919) suggests that the jointed appendages, or "arthrostyli," of chalcidogastrous larvae do not represent the "prolegs" directly, but that each has the relation to the latter of a stylus, that is, it is an appendicular part of the true appendage. Middleton (1921), on the other hand, thinks that the jointed appendages are direct representatives of the unjointed postpedes, because the two organs have identical positions on the tenth segment, and do not occur together. He would attribute the difference in form to the different habits of the larvae, since those species having typical, fleshy postpedes feed in the open on leaves and grasp the edges of the latter with the terminal appendages, while those having slender, jointed postpedes, bore into the stems of plants, or live in the protection of web nests or curled leaves. To the writer it appears most probable that the two forms of appendages are identical organs, and that the jointed variety is a secondary modification of the typical postpedes for a sensory function, the jointing being a mere subdivision of the appendage and not a true segmentation.

The observation made by Middleton (1921) that the postpedes of the larva become the cercus-like appendages of the adult sawfly has been discussed in the introductory part of this section, and need be given no further attention here, except to point out its importance,

if true, in establishing an identity between the terminal appendages of larval insects and the appendicular processes of the tenth segment in certain adult holometabolous insects.

Coleoptera.—In many families of the *Coleoptera* the abdomen of the larva is provided with a pair of appendicular processes arising from the dorsum of the ninth segment. These structures have been variously termed styli, cerci, pseudocerci, corniculi, and urogomphi.

The abdomen of the larva of *Dytiscus* ends with a transverse posterior surface of the narrow eighth segment (fig. 44 A), in the upper part of which the last pair of spiracles open through a median, vertical slit (*VIIISp*). From the membrane below the spiracular area of the eighth segment there arise laterally two slender, tapering processes (*ug?*) fringed with long hairs. Between the bases of these organs

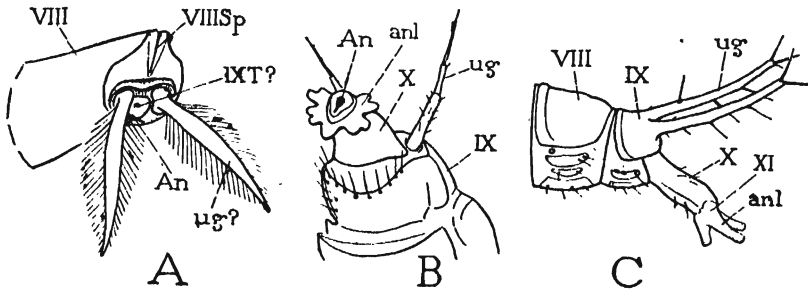

FIG. 44.—Terminal appendages of coleopterous larvae.

A, posterior end of abdomen of *Dytiscus circumcinctus* larva. B, end of abdomen of a silphid larva, *Thanatophilus* sp., with exserted anal lobes (from Kemner, 1918). C, end of abdomen of carabid larva, *Oodes helopioides*, with exserted anal lobes (from Kemner, 1918).

An, anus; *anl*, anal lobes; *ug*, urogomph.

is a small, median plate (*IXT?*), which appears to be a remnant of the ninth abdominal tergum. Ventral to it is the anal opening (*An*). According to Speyer (1922, Korschelt, 1924), each of the terminal appendages of the larva of *Dytiscus marginalis* is provided with three muscles, two inserted dorsally on its base, and one ventrally, all of which arise on the tergum of the eighth segment.

The morphology of the larval appendages of *Dytiscus* is difficult to determine. The apparent position of the organs on the rudimentary ninth segment makes it doubtful that they are true cerci, and the dorsal origins of their muscles is not in accord with the musculature of styli. It is claimed by Blunck (1918, Korschelt, 1924) that in all *Coleoptera* the first two primitive somites of the abdomen are united in the first definitive segment, and that, therefore, the segment bearing the terminal appendages is really the tenth. In this case we might

regard the terminal appendages of the *Dytiscus* larva as the cerci. However, the evidence presented by Blunck of the fusion of the first and second segments of the abdomen is not generally accepted by students of Coleoptera, and is not convincing, while the fact that the segment preceding the appendicular processes bears the eighth pair of abdominal spiracles would ordinarily be taken as conclusive evidence that this latter segment is the true eighth somite of the abdomen, especially since these respiratory apertures, as described by Blunck, have the structure typical of lateral abdominal spiracles.

For the present, therefore, the nature of the terminal appendages of the *Dytiscus* larva must be left in doubt, but if the organs do not belong to the series of lateral, stylus-like appendages, fully represented in *Coptotomus* and Gyrinidae, it is possible that they are structures homologous with those dorsal processes often developed on the ninth abdominal segment of other coleopterous larvae, which appear to be mere cuticular outgrowths, though they may become movable at their bases. The muscles inserted on the processes in *Dytiscus* are evidently not specific muscles of the appendages, but groups of segmental or intersegmental fibers that, by reason of their attachments at the bases of the processes, serve to move the latter.

The abdomen of most other coleopterous larvae consists of 10 distinct segments (fig. 44 B, C). The ninth segment is usually well developed and frequently supports a pair of processes (B, C, *ug*) arising from its dorsum. These processes are termed *urogomphi* by Böving, since from their segmental position it is clear that they can not be cerci. In some species the urogomphi are fixed outgrowths of the posterior end of the ninth tergum (C); in others they arise from the membrane behind the ninth tergal plate (B), and are then flexible at their bases. They vary much in size and shape from short, spine-like points to long, thick processes or multiarticulate filaments, and they are sometimes distinctly jointed. The urogomphi appear to be equivalent structures in all cases, and are probably but cuticular outgrowths of the ninth abdominal tergum, which in certain species become movable by a membranization of the tergal wall at their bases. The mobile appendages of the *Dytiscus* larva, therefore, are perhaps urogomphi of the rudimentary ninth segment, secondarily movable by some of the intersegmental muscles normally extending between the eighth and ninth segments.

The tenth abdominal segment in many coleopterous larvae is a short, often tubular structure (fig. 44 B, C, X), at the extremity of which is a small retractile and eversible membranous pad surrounding the anus, known as the "pygopodium" (C, XI), which may

be produced into two or more soft lobes (*anl*). It is claimed by Kemner (1918), from embryological evidence, that the so-called pygopodium is the rudimentary eleventh abdominal somite. The eversible pygopodial lobes, however, in no way represent appendicular organs, Kemner asserts, nor are they evaginations of the wall of the rectum, as they have been supposed to be; they are merely productions of the cercumanal area on which the longitudinal muscles from the tenth to the eleventh segment are attached. If the organs in question, therefore, are not of an appendicular nature, the term "pygopodia" should not be given to them, since it is convenient to apply this name specifically to the true appendages of the tenth, or pygidial, segment. The presence of a distinct though rudimentary eleventh segment in larvae of Coleoptera is of interest because of the general suppression of this segment in holometabolous insects.

TERMINAL LOBES OF THE PARAPROCTS

In a few of the lower Pterygota an appendicular lobe is borne by each of the paraprocts. These processes have been termed "paraprocti" by Crampton (1920). Examples of paraproct lobes occur in the Odonata and in the tridactylid Orthoptera.

The paraproct processes of Odonata occur in adult Anisoptera in the form of small, seta-bearing lobes projecting posteriorly from the ends of the paraprocts. Corresponding lobes are not present in the larvae of this group of dragonflies, in which the paraprocts, together with the elongate epiproct, form the valves that close the anal opening (fig. 12 A, B). In the larvae of Zygoptera, however, paraproct lobes are highly developed as the large, flat, tracheated plates that form the lateral caudal gills (C, *paptl*). The median gill (*cf*) is a similar lobe of the epiproct (*Eppi*), and is evidently comparable with the median caudal filament of Thysanura (fig. 7 A, B, C, *cf*).

In the Orthoptera paraproct lobes are well developed in the Tridactylidae, where they have the form of long processes resembling the cerci (fig. 45 A, B, *paptl*). In some species of *Ripipteryx* those of the male are incurved at the ends and are said to be used as claspers during copulation. In *Ellipes* (fig. 45 A, B) each process is borne on a membranous area at the end of the short paraproct (*Papt*). Crampton (1918, 1921) has given considerable significance to the "paraprocti" of the Tridactylidae, which he regards as homologous with the styli of the preceding segments, and as representatives of the exopodites of crustacean appendages (fig. 45 C, D, *expd*). Most other writers, including Walker (1919), regard the processes as sec-

ondary lobes of the paraprocts. It is highly unlikely that the structures in question are styli, since, as already shown, the paraprocts are not limb bases. Crampton's view regarding the relation of the paraproct process to crustacean exopodites will be discussed in the following Section of this paper.

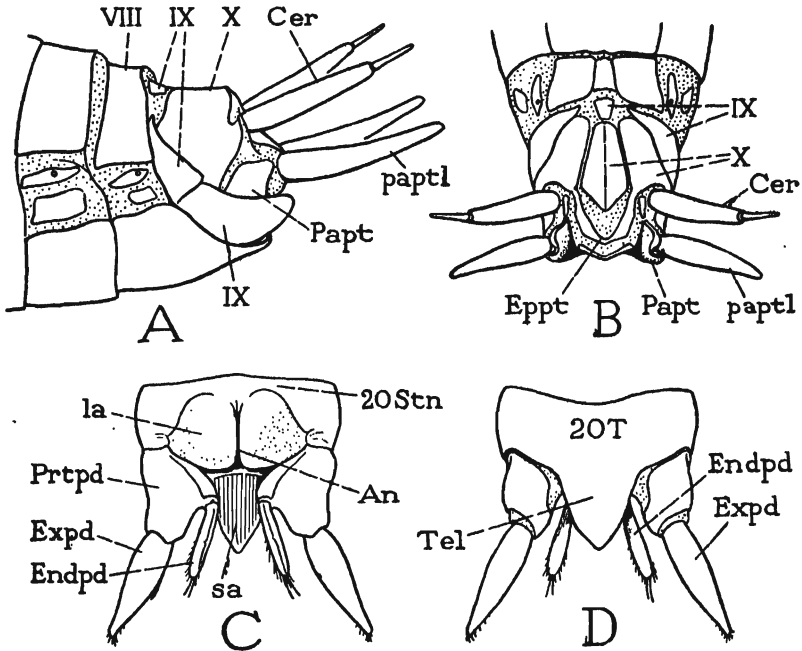

FIG. 45.—Terminal appendages of a tridactylid insect and an isopod crustacean.

A, posterior part of abdomen of *Ellipes minuta* (tridactylid orthopteron). B, the same, dorsal view. C, end of abdomen of *Porcellio* (isopod crustacean), ventral view. D, the same, dorsal view.

An, anus; Cer, cercus; Endpd, endopodite; Eppt, epiproct; Expd, exopodite; la, lamina sub-analis; Papt, paraproct; paptl, lobe of paraproct; Prtpd, protopodite; sa, lamina supra-analis; Tel, telson (fused with tergum of twentieth segment).

MORPHOLOGY OF THE ABDOMINAL APPENDAGES

There is no need at present to offer proof of the serial identity of the appendicular organs of the insect abdomen with the segmental appendages of the thoracic and cephalic regions of the body. Embryologists have amply demonstrated the continuity of appendage rudiments on the entire series of primitive somites, at least 20 in all, leaving only a prostomial lobe and a periproctial region devoid of true limb structures. To determine the homologies of the parts of the abdominal appendages with the parts of the better developed append-

ages on the anterior regions of the body, or with those of theoretically more generalized appendages, is quite another matter.

Theoretical Structure of Arthropod Appendages.—At the outset of an attempt to study the morphology of the rudimentary abdominal appendages of insects a difficulty is encountered arising from the lack of uniform opinion as to the structure of a generalized but fully segmented arthropod limb. Particularly is it necessary in a study of rudimentary appendages to know the structure of the basal part of a primitive appendage. In the thorax of modern insects the functional base of a leg is the coxa, and yet, it seems almost certain that at an earlier stage the true basis of the limb must have included the subcoxal region now forming the so-called pleuron and in some cases a lateral part of the definitive sternal plate of the supporting body segment. Then, the further question arises as to whether the subcoxa was once a free segment of the appendage, or whether it has been evolved secondarily by a differentiation of the primitive limb basis into subcoxal and coxal parts. Differences of opinion on such questions as these have led immediately to different interpretations of the basal parts of the abdominal appendages, and consequently to different views concerning the nature of the distal parts.

A simple condition of the limb base occurs throughout the Arachnida, which is well shown in any one of the legs of a phalangid (fig. 46 A). It is to be seen here that the leg is supported on a large basal segment (*LB*) that occupies the lateral wall of a segmental area of the body, and that it turns slightly forward and rearward on a dorsoventral axis (*a-b*) extending from the tergum above to the sternum below. To this large basal segment the telopodite is articulated by a dicondylic hinge on a horizontal axis (*f-g*). The first segment of the telopodite is a trochanter (*1Tr*).

In the majority of the Crustacea the proximal region of the leg has the same structure as in the Arachnida, there being a single basal segment, the coxopodite (fig. 46 B, C, *LB*), implanted directly in the ventro-lateral wall of the supporting body segment, and often articulated dorsally (*a*) with the tergal plate (*B, T*). The basis, however, is not prolonged ventrally as in the phalangid (*A*), and is inclined to be cylindrical (*C*). The telopodite articulates with the basis by its proximal segment (the first trochanter, or basipodite, *B, C, 1Tr*) on a horizontal, dicondylic hinge (*f-g*) having the same type of structure as that in the arachnid (*A*).

If, now, we look at a typical thoracic leg of an insect (fig. 46 D), it is seen that the proximal joint in the appendage corresponding structurally and functionally with the joint between the basis and the telop-

odite in the phalangid or crustacean leg (A, B, C, *f-g*) is that between the coxa and the trochanter (D, *f-g*). The coxa (*Cx*), however, is separated from the tergum (*T*), and often from the sternum (*Stn*), by a sclerotization, known as the "pleuron" (*Scx*), occupying the position in the lateral wall of the supporting body segment that is occupied by the limb basis in the phalangid and crustacean (A, B, C, *LB*). In other words, the basal region of the appendage in the case of the insect leg (D, *LB*) is composed of two parts (*Scx*, *Cx*) cor-

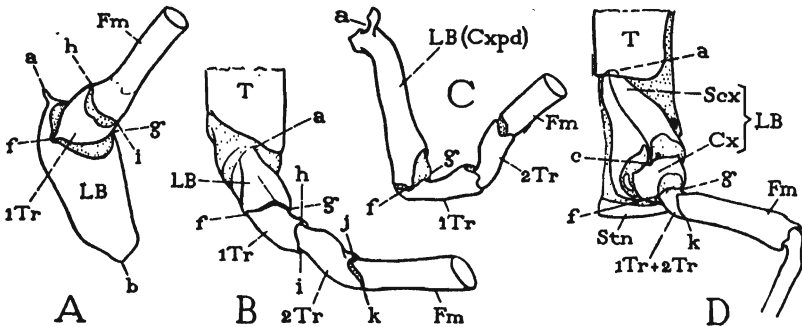

FIG. 46.—Basal parts of arthropod legs.

A, third right leg of a phalangid, *Liobunum*, showing limb basis (coxopodite) elongate ventrally (*LB*), turning antero-posteriorly on dorsoventral axis (*a-b*), with telopodite movable dorsoventrally on horizontal axis (*f-g*).

B, last right ambulatory leg of a crustacean, *Anaspides tasmaniae*, with small basis, or coxopodite (*LB*), on which the telopodite turns dorsoventrally on horizontal axis (*f-g*) of first trochanter, or basipodite (*1Tr*).

C, leg of an isopod crustacean, *Porcellio*, with elongate basis, or coxopodite (*LB*), to which the telopodite is articulated by a horizontal hinge (*f-g*) as in A and B.

D, mesothorax and middle leg of a young acridid nymph, *Melanoplus*, showing region of limb basis (*LB*), between the horizontal baso-telopodite hinge (*f-g*) and the tergum (*T*), subdivided into subcoxa (*Scx*) and coxa (*Cx*).

a, dorsal articulation of limb basis with body; *c*, dorsal subcoxo-coxal articulation; *Cx*, coxa; *Cxpd*, coxopodite (limb basis); *f-g*, axis of baso-telopodite hinge; *Fm*, femur (meropodite); *h-i*, axis of hinge between first and second trochanters; *j-k*, axis of trochantero-femoral hinge; *LB*, limb basis (coxopodite); *Scx*, subcoxa; *Stn*, sternum; *T*, tergum; *1Tr*, first trochanter (basipodite); *2Tr*, second trochanter (ischipodite).

responding with the single plate or segment (coxopodite) forming the basis of the arachnid and crustacean appendages illustrated (A, B, C). A condition similar to that in the insect thorax is found, however, in the thoracic region of the decapod crustaceans, where a large pleural plate occurs on each side of the body intervening between the coxae and the tergum. This plate is clearly a composite structure, the segmental areas of which are evidently derived from the subcoxal parts of the leg bases, because they support the gills of the

branchial chamber. Subcoxal sclerites occupying the lateral walls of the body segments are again found in the Chilopoda (fig. 27 A, *Scx*), and in the last leg-bearing segment they are here united with the coxa to form a single basal plate (*LB*) of the appendage, occupying the pleural region of the segment.

From comparative studies such as those just cited, the writer has come to regard the pleural subcoxa, or sclerotic area of the lateral body wall supporting the free part of an appendage, as the proximal part of the primary limb basis secondarily separated, wherever it occurs, from the distal part of the basis, which becomes the movable coxa, or functional base of the limb. On the other hand, many students of Arthropoda regard the subcoxa as a primitive limb segment, which has become suppressed or fused with the coxa wherever traces of it are not to be found in modern forms. The entire absence of a subcoxa in all Arachnida and in the majority of Crustacea, however, is against this view; and the lack of uniformity in the subcoxo-coxal musculature, when a subcoxa is present, suggests that the subcoxo-coxal joint is a recent division of the limb basis that has occurred principally in the Chilopoda and the Hexapoda. If the subcoxa is a secondary formation, then it must be assumed that the subcoxo-coxal muscles likewise are secondary, and that, as the subcoxa became differentiated from the coxa, most of the primitive basal muscles of the appendage were transferred to the coxa.

The subcoxa in its more primitive condition is best seen in the Chilopoda and in the thoracic segments of apterygote Hexapoda. It here consists of a circular fold or slight elevation of the body wall supporting the leg, containing one or more small sclerites, particularly in the region above the coxa. The large "pleura" of the thoracic region of pterygote insects, or the pleural plates of the branchial chambers of decapod crustaceans, undoubtedly represent highly specialized developments of the subcoxae; adapting the latter to uses quite independent of any function connected with the legs. The subcoxal plates in the thorax of holometabolous insect larvae, however, are relatively small and are closely associated with the coxae (figs. 3 B, C, 41 A, *Scx*₃). The region of the subcoxa *surrounds* the base of the coxa, but its ventral arc is reduced to a fold, which generally in the thorax of adult insects unites with the sternum. The sclerotized area of the subcoxa may be broken up into several small sclerites; in the thorax of pterygote insects there is typically a large supracoxal plate known as the "pleuron."

In a former paper the writer (1928) has given reasons for believing that the body of a gnathal appendage represents the basis of a leg. It

is similarly divided secondarily into two parts (*cardo* and *stipes*), though it is not clear that the two parts exactly correspond with the *subcoxa* and *coxa* of a thoracic leg. The palpi, however, are thus seen to be the telopodites of the head appendages. If the interpretation concerning the primary segmentation of a gnathal or a thoracic appendage into *basis* and telopodite is now carried to the appendages of the abdomen, the basal plates or basal lobes of the latter become the true limb bases, and the telopodites should be freely movable appendicular processes of the bases.

In general, then, it appears that the arthropod limb is divided by a joint near its base into a proximal part, the primary *limb basis*, and into a distal part, or *telopodite*. The baso-telopodite joint is the coxotrochanteral joint of a fully segmented limb, which is the joint between the coxopodite and the basipodite in terms usually employed by carcinologists. The use of the term "basipodite" by Börner (1904, 1921) to designate the subcoxo-coxal base of the limb creates a duplication in nomenclature that is likely to be confusing. The movement of the telopodite on the basis is typically in a vertical plane, produced by levator and depressor muscles arising in the basis (fig. 25 A, O, Q).

On the assumption that the basal mechanism of all the limbs is fundamentally the same in all groups of arthropods, we can imagine a simple primitive condition in the arthropodan ancestors in which the entire series of appendages had a uniform line of flexure near the body, along which the distal parts of the limbs, or telopodites, were movable in a vertical plane on their bases. The bases, on the other hand, turned forward and rearward on the axes of their attachments on the body. Wherever the basis is differentiated into a *coxa* and a *subcoxa*, the primitive basal movement of the appendage on the body is lost, but is replaced by a vertical axis of promotion and remotion between the *subcoxa* and the *coxa*, as the latter becomes secondarily the functional base of the limb. Finally, if the limb becomes rudimentary and loses its basal musculature, the basis might become transformed to a simple immovable lobe or plate of the wall of the supporting body segment, with the telopodite reduced to an appendicular process movable by muscles arising in the basis.

Other Theories on the Morphology of the Abdominal Appendages.—The principal problem encountered in a study of the abdominal appendages of insects is that of determining the homologies of the parts of the appendages with those of a generalized limb. The *basis*, the *stylus*, the *gonapophysis*, the eversible vesicle, each raise questions as to its nature and derivation.

Discussions on the morphology of the abdominal appendages of insects, and speculations on their possible homologies with the limbs of Crustacea have continued for half a century without leading to definite conclusions. They began at least with Wood-Mason (1879), who, in a paper on the origin of insects, interpreted the stylus-bearing plates of the abdomen of *Machilis* as the protopodites of primitively biramous appendages, of which the endopodites are represented by the gonapophyses, and the exopodites by the styli. The eversible vesicles, Wood-Mason suggested, may be homologues of nephridia, those of the eighth and ninth segments being converted into the genital ducts.

Diversities of opinion soon followed the publication of a more widely read paper by Haase (1889) on the morphology of the segmental appendages, containing not only a clear exposition of the appendicular nature of the stylus-bearing plates in the abdomen of Thysanura, but also a demonstration of the triple origin of the definitive abdominal sterna of insects in general from the union of the rudimentary embryonic limbs with the median sternal area in each segment. The styli, Haase claimed, are not the leg rudiments, but secondary structures of the nature of hairs, which have been converted into locomotory organs from sensory organs. The eversible vesicles he believed function as blood gills, but are to be traced back in all cases to coxal glands.

Wheeler (1893) and earlier students of the embryology of insects regarded the gonapophyses of the genital segments as the direct representatives of the appendages of these segments. Considering the late development of the gonapophyses, however, and their invariable median position on the body of the insect, Heymons (1896a) contended that the genital processes are secondary integumental outgrowths having no relation to the appendages, and that the latter are preserved in the styli and cerci. Heymons' heterodox opinion brought a severe criticism from Verhoeff (1896), who defended the limb nature of the gonapophyses as an established fact, and maintained that the identity of the abdominal styli with the thoracic styli of *Machilis* could not be disputed, and that therefore both are merely appendicular processes of the legs. In reply to Verhoeff, Heymons (1896b) emphasized his former statements in evidence of his view concerning the nature of the appendicular parts of the abdomen, pointing out that, during embryonic development of the Orthoptera, the abdominal appendages disappear, and the gonapophyses are later formed quite independent of the limbs. He argued that if the gonapophyses are the limbs, intermediate stages should be found some-

where between gonapophyses and legs. The styli, Heymons reasserted, are direct derivatives of the abdominal appendages, and occur in primitive forms such as *Campodea* and *Japyx* in which gonapophyses are lacking. From the abdominal limb rudiments of the embryo, Heymons showed, are produced not only the typical styli, but also the cerci, and the lateral gills of the larvae of Ephemera and *Sialis*.

Since Heymons' views are based on embryological studies they deserve more attention than purely theoretical considerations. In his studies of the development of the appendages of *Periplaneta*, *Ectobia*, and *Mantis*, Heymons (1896a) observes that each limb rudiment of the ninth segment is early marked by a circular constriction, which divides the appendage into a broader proximal part and a slenderer distal part. The proximal part flattens out and finally is incorporated in the definitive sternal plate of the segment, while the distal part becomes longer and slenderer and develops directly into the stylus. The gonapophyses, on the other hand, Heymons claims, are secondary outgrowths of the sterna in the Orthoptera. Concerning them he says: "In *Gryllus* there can be no doubt of the nature of the gonapophyses. Abdominal extremities are present in the embryo on the eighth and ninth segments, but they later degenerate, and in old embryos as well as in young larvae leave not the slightest rudiments. It is only later, in older larvae, that the gonapophyses appear, and they are therefore undoubtedly to be regarded as secondary integumental outgrowths." Thus, according to Heymons, the stylus and not the gonapophysis is the representative of the telopodite in an abdominal appendage.

It must be conceded that the facts of embryonic development do not necessarily recapitulate phylogenetic evolution, since we can never be sure that the early stage of an organ reproduces the primitive form of that organ, and this must be particularly true of a rudimentary structure. Thus, if the telopodite of a limb bearing a basal exite process has long been lost, the limb rudiment in the embryo might be supposed to consist of the limb basis and the accessory process, and to lack the telopodite element entirely. Hence, while Heymons' evidence of the nature of the styli is highly suggestive that the styli are the rudiments of the telopodites, it does not demonstrate the point. On the other hand, Heymons' line of reasoning concerning the gonapophyses makes it seem almost certain that the genital processes are not the telopodites of the gonopods, but the facts of development can scarcely be taken as evidence that the gonapophyses do not belong to the genital appendages. It is amply proven in the *Thysanura* that the gonapophyses are processes of the gonopods, and in

the Orthoptera they are undoubtedly outgrowths of the parts of the definitive sterna derived from the bases of these appendages.

Verhoeff (1903), retaining his former views on the homologies between the abdominal and thoracic appendages, but going more into detail, proposed, on theoretical grounds, that the stylus-bearing plates of the insect abdomen represent the coxae, which in the abdomen he distinguished as "coxites," or in the genital segments as "gonocoxites." According to Verhoeff's theory, the telopodites are lost from all the abdominal appendages except those of the eighth and ninth segments, where they become the gonapophyses; the styli are secondary lateral outgrowths of the coxae, equivalent to the coxal spurs of the thoracic legs of *Machilis*; and the eversible vesicles are median coxal structures comparable with the coxal glands of Diplopoda.

Börner, though at first taking Heymons' view of the nature of the gonapophyses, later (1904) agrees with Verhoeff that the genital processes represent the telopodites of the abdominal appendages, preserved only on the gonopods. Regarding the supporting plates, however, Börner differs from Verhoeff in that he identifies them as "basipodites," meaning by this term that each plate is the equivalent of the coxa and subcoxa of a thoracic leg. (The same idea concerning the nature of the basal plates is followed in the present paper, but Börner's term "basipodite" is replaced with "limb basis" to avoid confusion with the more usual application of the other word to the first trochanter.)

Silvestri (1903, 1905) regards the basal segment of an arthropod limb as being in all cases a subcoxa (including the so-called coxopodite of Crustacea), and he would divide the appendage into a basis (subcoxa) and a telopodite at the subcoxo-coxal joint. Applying this interpretation of the basal structure of the limb to the abdominal appendages of insects, Silvestri (1905) identifies the stylus-bearing plates of the Thysanura with the subcoxae. The styli he regards as the rudiments of the telopodites, with their bases representing the coxae. Silvestri, therefore, admits no homology between the abdominal styli and those of the thorax in *Machilis*; the leg styli he claims are secondary outgrowths of the coxal integument. Verhoeff (1903) had figured a coxal muscle attached to the leg stylus of *Machilis*, but this supposed muscle Silvestri shows does not exist—an observation in accord with statements by earlier as well as by subsequent writers, and one easily verified.

The most interesting feature in Silvestri's interpretation of the morphology of the abdominal limbs is his proposal that the genital

apophyses are serially homologous with the eversible sacs of the pre-genital segments. Silvestri argues as follows: On the first abdominal segment of *Projapyx* and *Anajapyx* there are borne on each subcoxa (stylus-bearing plate) a typical stylus and, mesad of it, a cylindrical or conical process. In *Machilis* and *Nicoletia* each subcoxa of the first segment has a retractile vesicle, and in *Campodea* only a cylindrical process. The following six segments of Machilidae bear on the subcoxae both styli and vesicles, but on the next two, the genital segments, each subcoxa has a stylus and, in some genera, mesad to it a genital process. Thus Silvestri contends that the gonapophysis is evidently an eversible sac *permanently everted*. Muscles he observes are attached to each appendage, though he does not point out that those of the gonapophysis are inserted on the base of the process, while those of the vesicles traverse the organ to be inserted in its extremity.

The abdominal appendages of insects have not lacked attention from students of arthropod phylogeny, because their several parts make up a composite limb pattern that may be supposed to conform with the biramous limb pattern of crustacean appendages, and thus indicate either that insects are closely related to the Crustacea, or that the primitive arthropod limb was a biramous structure. Writers who espouse the idea of a crustacean ancestry for insects, following Wood-Mason (1879), interpret the stylus as the exopodite, and find the homologue of the endopodite in the gonapophyses of the genital appendages. The theory must assume that the endopodites have been suppressed on the pregenital segments, since the eversible vesicles are eliminated as possible telopodite homologues by the fact that they sometimes occur in duplicate.

The theoretical possibilities of aligning the appendages of insects with those of Crustacea have been exhaustively searched by Crampton. In a study of the terminal appendages of the tridactylid orthopteron, *Ellipes*, Crampton (1921) adduces evidence that he takes to be conclusive of the biramous nature of insect appendages. The dorsal pair of terminal appendicular processes in the Tridactylidae are undoubtedly the cerci (fig. 45 A, B, *Cer*); the ventral pair (*pa^{ptl}*) are the lobes of the paraprocts ("paraprocti"). After removing the end of the abdomen and spreading the parts out from below until they lie in one plane, Crampton makes a comparison of the tridactylid appendages in this position with the uropods of an isopod crustacean in the normal position (fig. 45 C, D), and arrives at the conclusion that the cerci of the former correspond with the endopodites of the latter, and that the paraproct lobes of *Ellipes* represent the exopodites

of the isopod. The paraprocts themselves Crampton regards as the protopodites (i. e., combined coxopodites and basipodites) of the terminal appendages. The interpretation of the paraproct lobes as exopodites is consistent with other evidence that the styli are exopodites, for the paraproct lobes fall in line with the styli, or would do so if styli were present in the tridactylids, and the abdominal styli are serially continuous with the thoracic styli of *Machilis*, which appear to have an exopodite status, and therefore suggest that the entire series of styliform organs are exopodites.

There are several weak places in the above line of reasoning. In the first place, the writer fails entirely to get Crampton's view from the comparison between the tridactylid and the isopod, since, with the terminal parts of both in the normal condition (fig. 45 B, D), the cercus of the insect (*Cer*) surely has the position of the exopodite (*Expd*) of the crustacean uropod, while the paraproct lobe (*paptl*) corresponds in position with the small endopodite (*Endpd*) borne by the basal plate of the uropod (C). In the second place, a more careful examination of details shows that the cercus (B, *Cer*) has no anatomical relation with the paraproct (*Papt*), being situated dorsad of the latter in a position corresponding with that of the base of the crustacean uropod (D). Furthermore, as has already been shown, there is no evidence whatever to support the idea that the paraprocts of insects are parts of the appendages. Their musculature indicates that they are mere lateroventral, subanal lobes of the eleventh abdominal sternum. The cerci have no muscles arising in the paraprocts. Finally, the embryological evidence concerning the nature of the cerci appears to show definitely that the cerci are the *entire* appendages of the eleventh segment, and that their bases, if present at all, are retained in a basal ring of each organ. Hence, until some radically new information comes to light concerning the cerci, there is no question of exopodite or endopodite connected with them. Our present information is to the effect simply that the *cerci are the appendages of the eleventh abdominal segment*.

The lobes of the paraprocts, whether the "paraprocti" of the tridactylids, the small lobate ends of the paraprocts of the Anisoptera, or the lateral gill plates of the Zygoptera, have no validated claim to an appendicular origin. They must, then, for the present be regarded as secondary outgrowths of the subanal lobes of the sternum of the eleventh abdominal segment, comparable to the various median outgrowths of the supra-anal plate of the same segment.

The most nearly convincing evidence of the biramous nature of insect appendages is, admittedly, the presence of styliform processes

on the mesothoracic and metathoracic legs of *Machilis* closely resembling the styli of the abdomen. Without this coincidence, or if *Machilis* and its coxal spurs had not survived to modern times, it is doubtful if entomologists would ever have thought of regarding the abdominal styli or the cerci as other than direct rudiments of legs.

Conclusions.—The abdominal appendages of insects are rudimentary limbs. Each consists of a basis and usually one or more distal appendicular parts, including a stylus, an eversible or retractile vesicle, and a gonapophysis. From the facts known of the comparative structure of the abdominal appendages, and from theoretical considerations we may draw the following tentative conclusions relative to the homologies of the parts of the appendages, but it must be admitted that the evidence at hand is not sufficiently definite to establish any particular view concerning them.

The *limb bases* of the abdominal appendages are the lobes or plates of the walls of the body segments that support the appendicular processes. They are usually well developed in larval insects, but in most adults they are partially or wholly united or blended with the sternum, or in the male genital segment fused also with the tergum; in the eleventh segment they are reduced to small basal rings of the cerci, or entirely obliterated. Generally there is no distinction between coxal and subcoxal regions in the limb bases of the abdomen. In position on the body the abdominal limb bases usually fall in line with the subcoxae or pleural areas of the thorax. But since there is no apparent reason for the development of large subcoxal plates on the abdominal segments, such as those of the pterygote thorax, it is not to be supposed that the limb bases of the abdomen represent the subcoxae alone. It is more probable that their principal parts are derived from the flattened coxae, or that the structures in most cases may represent primitive limb bases undifferentiated into coxae and subcoxae. In the caterpillars and sawfly larvae, however, the principal segment of each abdominal leg appears to be the coxa, which is quite distinct from a subcoxal lobe of the wall of the body segment to which it is attached. The abdominal limb bases are seldom movable on the body, since they commonly lack muscles corresponding with the basal muscles of the gnathal and thoracic appendages arising on the body wall. Exceptions to this rule are found in the male genital segment, where the bases of the gonopods are occasionally provided with muscles and are independently movable; but in such cases it is to be suspected, at least, that the muscles are secondary developments.

The *styli*, or other homologous appendicular processes of the abdomen, are of wide occurrence in insects, and serve a variety of

functions, to which they are adapted by structural modifications. The styliform type is not necessarily the primitive form of the organs. The abdominal styli may be serially homologous with the thoracic coxal styli of *Machilis*, or the latter may be merely large spurs resembling the abdominal styli, from which they differ in lacking muscles. The abdominal styli are individually movable on the limb bases by muscles arising in the latter. If they are not the rudimentary main shafts of the abdominal limbs, they are exite lobes of the coxae analogous with the epipodites of crustacean appendages. They are not comparable with the exopodites of Crustacea, because the exopodite branch of a typical biramous limb is an exite of the first trochanter, or basipodite.

There are many reasons for regarding the abdominal styli or their derivatives in insects as the rudimentary telopodites of the abdominal appendages. The styli seldom lose their muscles, except when they are immovably united with the bases; in some insects they take an active part in locomotion; they may be jointed in a manner suggesting at least a true segmentation, and in the larvae of *Sialis* they have intrinsic muscles in their basal segments. The styli of the gonopods in male pterygote insects, especially in the holometabolous orders, are commonly modified to serve as grasping or clasping organs during copulation. The styli are the most generally persistent of the distal parts of the abdominal appendages. If it were not for their likeness in apterygote and orthopteroid insects to the coxal spurs of *Machilis*, it seems doubtful if the abdominal styli would ever have been regarded as anything else than the rudimentary telopodites of the abdominal appendages, represented in a similar form by the cerci on the eleventh segment.

The *vesicles* of the abdominal appendages of Apterygota, the *gill tubercles* of the larva of *Corydalus*, and the *plantar lobes* of the larval abdominal legs of Lepidoptera and chalcidogastrous Hymenoptera are all organs of a similar and unique type of structure. They are essentially exerted or invaginated lobes of the coxal areas of the limb bases lying mesad of the bases of the styli, and are retractile by muscles inserted within their distal parts. In the case of the Apterygota the muscles arise in the limb bases; in the others they arise from the lateral walls of the body. We might, with Verhoeff, regard these sacs as derivatives of coxal glands, since integumentary glands sometimes take the form of eversible and retractile pouches. The coxal vesicles, however, serve a variety of purposes, and they are more simply explained as endite lobes of the coxae, which in some cases have become normally invaginated. They may thus be likened to the

endite lobes of the gnathal appendages, and, as the latter, they sometimes occur in duplicate on each appendage.

The *gonapophyses* are hollow, median outgrowths of the bases of the gonopods, developed in both male and female insects during postembryonic stages. They are movable by muscles arising in the limb bases, or in areas of the genital segments derived from the latter, except where they are operated by the segmental muscles of the body. Theoretically the *gonapophyses* may be supposed to be either the telopodites (endopodites) of the gonopods, or endite lobes of the bases of these appendages. There are several objections to the first view. The *gonapophyses*, for example, are never truly segmented, and never have a form suggestive of a leg structure; they occur only on the appendages of the genital segments, unless the cylindrical processes of the first abdominal segment in certain *Dicellura* are homologous structures; and finally, they serve only in a particular capacity in connection with oviposition and copulation, except in insects where they are secondarily adapted to form a stinging organ. These facts, together with the invariable median position of the *gonapophyses* on the gonopod bases, suggest that the *gonapophyses* are basal endites of the gonopods, movable by muscles arising in the basis, as such endites usually are, and specially adapted to the reproductive functions. The genital apophyses might then be regarded as serially homologous with the eversible or retractile vesicles of the pregenital appendages and certain larval pygopods, in which case Silvestri's idea that they represent "permanently everted eversible vesicles" is better stated in the reverse, namely, that the eversible vesicles are inverted *gonapophyses*. However, the vesicles do not occur at points on the gonopod bases corresponding with the origins of the *gonapophyses*, and the musculature of the two sets of organs is characteristically different. It is perhaps possible that the *gonapophyses* are subcoxal endites, and the vesicles coxal endites.

If none of the appendicular processes of the abdominal limbs can be satisfactorily identified with the telopodite of a primitive appendage, we must conclude that the abdominal telopodites have been lost from all but the terminal segment, where they form the cerci, and that the various persisting appendicular structures are accessory processes of the limb bases. Otherwise, we must choose between the *gonapophyses* and the styli as possible representatives of the telopodites. Of the two, the styli certainly present better credentials, considering their occurrence on many segments of the abdomen as contrasted with the segmental localization of the *gonapophyses*, their structural and functional versatility by comparison with the limitations of the

genital apophyses in form and use, and their leglike relations to the limb bases as opposed to the median, proximal origins of the gonapophyses. All these points qualify the abdominal styli for true limb rudiments, and give the genital processes the status of basendites specially developed for reproductive purposes. The pretensions of the abdominal styli to telopodite origin are opposed only by their similarity to the thoracic styli of *Machilis*; but there is nothing to show that these leg structures are not mere coxal spurs resembling in form but fundamentally unlike the muscled appendages of the abdomen, the styli-form shape of which is but one of their many structural adaptations.

A discussion of the phylogeny of insects, or particularly of the possible origin of insects from any other group of existing arthropods is beyond the intended scope of the present paper. A recent work by Tillyard (1930) on the evolution of the Insecta, though somewhat partisan in favor of myriapodan descent, gives many reasons for believing that insects are not directly related to the Crustacea. And yet, the weight of evidence, whether put forth by claimants of a myriapodan or a crustacean ancestry for insects, seems to depend largely on minimizing or disqualifying the evidence on the other side. However, if we were to give equal weight to arguments on both sides of the question, the insects would be cut off from all ancestral ties, and thereby deprived of a respectable pedigree—unless they are able to take care of themselves through all the unknown ages of time before they are first known to us as fully-winged hexapods in the Carboniferous deposits. To the writer it appears that all the principal arthropod groups must represent independent lines of descent from some remote ancestral forms embodying the potentialities of a spider, a crab, a centipede, or an insect. It has recently been emphasized by Clark (1930) that the chronic inability of the evolutionary theory in its usual form to explain the lack of intermediates between the major groups of animals constitutes a real weakness of the theory, which calls for a new concept of the method by which distinct types of organisms have been produced. The condition to which Clark refers is well exemplified within the Arthropoda, where connective forms between the classes are unknown. Moreover, it is impossible to construct imaginary arthropods that will fill the blanks, as, for example, the three-cornered gap between the crustaceans, the myriapods, and the insects. Considering that embryos develop before our eyes by ways that are still inscrutable, it takes a strong faith in established ideas to believe that organic evolution has proceeded entirely by the means we have furnished for its guidance.

ABBREVIATIONS USED ON THE FIGURES

- a-a*, dorso-pleural groove.
a-b, axis of articulation of limb base on body.
ab, abductor muscle.
Ac, antecosta.
acs, antecostal suture.
ad, adductor muscle.
Aed, aedeagus.
An, anus.
Ap, apodeme.
Apd, segmental appendage.
Appt, sternal apotome.
Bnd, basendite.
Brn, branchia (gill).
brncs, branchial muscles.
Bspd, basipodite (first trochanter).

c-d, axis of subcoxo-coxal joint.
Cer, cercus (uropod).
cf, caudal filament.
Col, colophora.
Con, nerve connective.
ct, coxo-trochanteral joint.
Cx, coxa.
Cxpd, coxopodite.

D, dorsum.
d, dorsal muscles.
del, lateral external dorsal muscles.
dem, median external dorsal muscles.
dil, lateral internal dorsal muscles.
dim, median internal dorsal muscles.
dl, dilator muscle.
dm, median dorsal muscles.
DMcl, longitudinal dorsal muscles.
DTra, dorsal longitudinal tracheal trunk

Endpd, endopodite.
Eppt, epiproct.
Expd, exopodite

l-g, axis of baso-telopodite joint.
Fm, femur (meropodite).
ft, femoro-tibial joint.
Fur, furcula.

gmcls, muscles of gonapophysis.
Gng, ganglion.
Gon, gonapophysis.
Gp, gonopod.
GSeg, genital segment.

Hpn, hypandrium.
Ht, heart.
Hypt, hypoproct.

I, tergal promotor muscle of appendage.
ip, intestinal process.
lsg, intersegmental fold.
Ist, intersternite

J, tergal remotor muscle of appendage

k, interfurcal sternal ridge.

L, leg.
l, lateral body muscles.
la, lamina subanalis.
LB, limb basis.
le, external lateral muscles.
li, internal lateral muscles.
lStn, last pregenital sternum.
lT, last pregenital tergum.
LTra, lateral longitudinal tracheal trunk.

Mb, intersegmental membrane (conjunctiva).
mb, membrane.
Mcl, longitudinal muscles.
mcls, muscles.
mn, manubrium.

NIG, neural groove.

O, levator muscle of first trochanter.
Ovd, oviduct.

p, paratergal muscle.
Papt, paraprot
paptl, lobe of paraprot.
patg, paratergite.
Pc, precosta.

- anatomie und Histologie der Abdominal- und Thoraxschmückenlarven. *Zeitschr. wiss. Zool.* 134: 180-269,
- vergleichende Morphologie des 2. und 3. Abdominalsegmenten Libellen. *Zool. Jahrb., Anat.* 39: 87-200, 25 text
- Die Muskulatur von *Astacus fluviatilis* (Potamobius) Beitrag zur Morphologie der Decapoden. *Zeitschr. wiss. Zool.* 78: 355-521, 14 figs.
- Student's text-book on Zoology, Vol. 3. London.
- Analysis Diplopoda, Vol. 1, Anatomie, 272 pp., 345 figs.,
- Zool. Jahrb.*, 3, Suppl. 6: 773-806, pls. 38-44.
- Anatomy and metamorphosis of the apple maggot, by J. A. Walsh. *Journ. Agric. Research* 28: 1-36, 6 pls.
- Life history and physiology of the honey-bee, 327 pp., 108 figs.
- Evolutionary biology and evolution of the insect head and its appendages. *Misc. Coll.*, 81, No. 3, 158 pp., 57 figs.
- Die Muskulatur der Larve von *Dytiscus marginalis* L.
- Beitrag zur Morphologie des Insektenkörpers. *Zeitschr. wiss. Zool.* 134: 423-492, 21 figs., pl. 7. Also in Korschelt (1924), Chapter 13.
- L. F. (1929). Homologies of tracheal branches in the nymph of *Anax junius* based on their correlation with the muscles they supply. *Ann. Ent. Soc. America* 22: 297-308, 1 pl.
- DÜRCKHEIM, H. (1828). Considérations générales sur l'anatomie comparée des animaux articulés, auxquelles on a joint l'anatomie descriptive du *Colontha vulgaris*, 434 pp., 10 pls. Paris, Strasbourg, Bruxelles.
- O. W. (1922). Researches on the insect metamorphosis. *Trans. and Proc. Roy. Soc. S. Australia* 46: 319-527, pls. 15-30.
- ARD, R. J. (1917). The biology of Dragonflies, 396 pp., 188 figs. Cambridge.
- (1930). The evolution of the Class Insecta. *Roy. Soc. Tasmania, Papers and Proc.* 1930: 89 pp., 19 figs.
- ER, G. (1903). Über die Metamorphose der Trichopteren. *Abh. Gebiete Naturwiss. naturwiss. Verein Hamburg* 18, 154 pp., 4 pls.
- HOEFF, K. W. (1896). Zur Morphologie der Segmentanhänge bei Insecten und Myriopoden. *Zool. Anz.* 19: 378-383, 385-388.
- (1903). Zur vergleichenden Morphologie der Coxalorgane und Genitalanhänge der Tracheaten. *Zool. Anz.* 26: 60-77, 15 figs.
- F. (1905). Über den Thorax von *Gryllus domesticus*. II. Die Muskulatur. *Zeitschr. wiss. Zool.* 78: 355-521, 14 figs.
- CKER, E. M. (1922). The terminal structures of orthopteroid insects: a phylogenetic study. Part II. *Ann. Ent. Soc. America* 15: 1-76, 11 pls.
- ALLEGREN, H. (1914). Die Atmung bei den Arthropoden. II. Die Mechanik der Atembewegungen bei Aeschnalarven. *Lunds Univ. Arrskrift*, N. F. 10: 1-24, 1 pl.